

# User's Manual

## Desktop Monitor

MultiSync® E224FL

MultiSync® E244FL

MultiSync® E274FL

MODEL: E224FL/E224FL-BK, E244FL/E244FL-BK, E274FL/E274FL-BK

The regulations for this monitor applied to one of model names listed above.

Please find your model name on the label on the rear side of the monitor.

# Table of Contents

---

Registration Information .....	1	Important Information .....	3
TCO Certified.....	2		

## Product Features

---

### Chapter 1 Installation and Connections

---

Parts Name and Functions .....	13	Connections.....	17
Control Panel.....	13	Signal type and terminal connection.....	20
Terminal Panel.....	14	Connecting devices .....	22
Installation .....	16	Flexible Arm Installation.....	23
Attach the base to the LCD monitor stand.....	16	Remove the Monitor Stand for Mounting.....	23
Connect the power cord and signal cables.....	16	Mount the Flexible Arm.....	23
Adjustable Stand with Pivot Capability .....	16	Re-attaching the Original Stand .....	24

### Chapter 2 Basic Operation

---

Using the OSD (On-Screen Display) Controls.....	26	Power management function LED indicator patterns .....	27
Changing the Input.....	27		

### Chapter 3 Troubleshooting

---

Screen Image and Video Signal Issues.....	29	Hardware Issues.....	30
---	----	----------------------	----

### Chapter 4 Specifications

---

E224FL .....	33	E274FL .....	35
E244FL .....	34		

### Appendix A OSD Controls List

---

Luminance .....	37	System Setup .....	38
Image Setup .....	37	Extra .....	38
Color Setup.....	37	OSD Warning .....	38
OSD Setup .....	37		

### Appendix B Manufacturer's Recycling and Energy Information

---

Disposing of your old NEC product .....	40	WEEE Mark (European Directive 2012/19/EU and amendments).....	40
Energy Saving .....	40		

# Registration Information

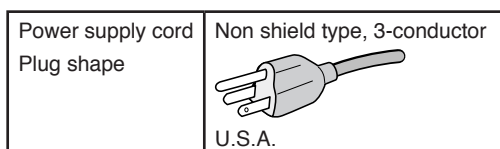
## Cable Information

**CAUTION:** Use the provided specified cables with this product so as not to interfere with radio and television reception. For HDMI, DisplayPort, USB and USB-C®, please use a shielded signal cable. Use of other cables and adapters may cause interference with radio and television reception.

## FCC Information

**WARNING:** The Federal Communications Commission does not allow any modifications or changes to the unit EXCEPT those specified by Sharp NEC Display Solutions of America, Inc. in this manual. Failure to comply with this government regulation could void your right to operate this equipment.

1. The power supply cord you use must have been approved by and comply with the safety standards of U.S.A., and meet the following condition.



2. This equipment has been tested and found to comply with the limits for a Class B digital device, pursuant to part 15 of the FCC Rules. These limits are designed to provide reasonable protection against harmful interference in a residential installation. This equipment generates, uses, and can radiate radio frequency energy, and, if not installed and used in accordance with the instructions, may cause harmful interference to radio communications. However, there is no guarantee that interference will not occur in a particular installation. If this equipment does cause harmful interference to radio or television reception, which can be determined by turning the equipment off and on, the user is encouraged to try to correct the interference by one or more of the following measures:

- Reorient or relocate the receiving antenna.
- Increase the separation between the equipment and receiver.
- Connect the equipment into an outlet on a circuit different from that to which the receiver is connected.
- Consult your dealer or an experienced radio/TV technician for help.

If necessary, the user should contact the dealer or an experienced radio/television technician for additional suggestions. The user may find the following booklet, prepared by the Federal Communications Commission, helpful: "How to Identify and Resolve Radio-TV Interference Problems." This booklet is available from the U.S. Government Printing Office, Washington, D.C., 20402, Stock No. 004-000-00345-4.

## SUPPLIER'S DECLARATION OF CONFORMITY

This device complies with Part 15 of the FCC Rules. Operation is subject to the following two conditions. (1) This device may not cause harmful interference, and (2) this device must accept any interference received, including interference that may cause undesired operation.



<b>U.S. Responsible Party:</b>	<b>Sharp NEC Display Solutions of America, Inc.</b>
<b>Address:</b>	<b>3250 Lacey Rd, Ste 500 Downers Grove, IL 60515 (630) 467-3000</b>
<b>Tel. No.:</b>	
Type of Product:	LCD Monitor
Equipment Classification:	Class B Peripheral
Model:	E224FL, E224FL-BK, E244FL, E244FL-BK, E274FL, E274FL-BK

(For Customers in U.K.)

#### IMPORTANT

- The wires in this mains lead are coloured in accordance with the following code:

**GREEN-AND-YELLOW:** “Earth”  
**BLUE:** “Neutral”  
**BROWN:** “Live”

- As the colours of the wires in the mains lead of this apparatus may not correspond with the coloured markings identifying the terminals in your plug proceed as follows:
  - The wire which is coloured GREEN-AND-YELLOW must be connected to the terminal in the plug which is marked by the letter **E** or by the safety earth symbol  $\perp$  or coloured green or green-and-yellow.
  - The wire which is coloured BLUE must be connected to the terminal which is marked with the letter **N** or coloured black.
  - The wire which is coloured BROWN must be connected to the terminal which is marked with the letter **L** or coloured red.
- Ensure that your equipment is connected correctly. If you are in any doubt consult a qualified electrician.

**“WARNING: THIS APPARATUS MUST BE EARTHED.”**

## TCO Certified

### TCO Certified — a third-party sustainability certification for IT products

TCO Certified is a global sustainability certification for IT products, available for computers, mobile devices, display products and data center products. Criteria cover both social and environmental sustainability and enable circular solutions. Compliance with criteria is independently verified. TCO Certified is a third-party certification in accordance with ISO 14024.

To see a list of our TCO certified monitors and their TCO Certification (in English only), visit our website at:

[https://www.sharp-nec-displays.com/global/about/legal\\_regulation/TCO\\_mn/index.html](https://www.sharp-nec-displays.com/global/about/legal_regulation/TCO_mn/index.html)

**⚠ CAUTION:** Please refer to “CAUTION 2”.

- The intended primary use of this product is as an Information Technical Equipment in an office or domestic environment.
- The product is intended to be connected to a computer and is not intended for the display of television broadcast signals.

### Registration Information

NEC is a registered trademark of NEC Corporation.

DisplayPort™ and the DisplayPort™ logo are trademarks owned by the Video Electronics Standards Association (VESA®) in the United States and other countries.

MultiSync® is a trademark or registered trademark of Sharp NEC Display Solutions, Ltd. in Japan and other countries.

Microsoft® and Windows® are either registered trademarks or trademarks of Microsoft Corporation in the United States and/or other countries.

The terms HDMI, HDMI High-Definition Multimedia Interface, HDMI Trade Dress and the HDMI Logos are trademarks or registered trademarks of HDMI Licensing Administrator, Inc.

USB Type-C® and USB-C® are registered trademarks of USB Implementers Forum.

All other brands and product names are trademarks or registered trademarks of their respective owners.



- NOTE:**
- (1) The contents of this manual may not be reprinted in part or whole without permission.
  - (2) The contents of this manual are subject to change without notice.
  - (3) Great care has been taken in the preparation of this manual; however, should you notice any questionable points, errors or omissions, please contact us.
  - (4) The image shown in this manual is indicative only. If there is inconsistency between the image and the actual product, the actual product shall govern.
  - (5) Notwithstanding articles (3) and (4), we will not be responsible for any claims on loss of profit or other matters deemed to result from using this device.
  - (6) This manual is commonly provided to all regions so they may contain descriptions that are pertinent for other countries.



# Important Information

## Safety Precautions and Maintenance







FOR OPTIMUM PERFORMANCE, PLEASE NOTE  
THE FOLLOWING WHEN SETTING UP AND  
USING THE LCD COLOR MONITOR:







### About the Symbols

To ensure safe and proper use of the product, this manual uses a number of symbols to prevent injury to you and others as well as damage to property. The symbols and their meanings are described below. Be sure to understand them thoroughly before reading this manual.

 <b>WARNING</b>	Failing to heed this symbol and handling the product incorrectly could result in accidents leading to major injury or death.
 <b>CAUTION</b>	Failing to heed this symbol and handling the product incorrectly could result in personal injury or damage to surrounding property.







### Examples of symbols

	 Indicates a warning or caution. This symbol indicates you should be careful of electric shocks.
	 Indicates a prohibited action. This symbol indicates something that must be prohibited.
	 Indicates a mandatory action. This symbol indicates that the power cord should be unplugged from the power outlet.






 <b>WARNING</b>	
1	 <b>UNPLUG THE POWER CORD</b> Unplug the power cord if the product malfunctions. Should the product emit smoke or strange odors or sounds, or if the product has been dropped or the cabinet broken, turn off the product's power, then unplug the power cord from the power outlet. Contact your dealer for repairs. Never try to repair the product on your own. Doing so is dangerous.
2	 <b>HAZARDOUS VOLTAGE</b>  <b>DO NOT DISASSEMBLE</b>  <b>PROHIBITED</b> Do not open or remove the product's cabinet. Do not disassemble the product. There are high voltage areas in the product. Opening or removing product covers and modifying the product may expose you to electric shock, fire, or other risks. Refer all servicing to qualified service personnel.
3	 <b>PROHIBITED</b> Do not use the product if it has structural damage or if its stand has cracked or peeled. If you notice any structural damage such as cracks or unnatural wobbling, please refer servicing to qualified service personnel. If the product is used in this condition, the product may fall or cause personal injury.



## WARNING




4	 PROHIBITED  REQUIRED	<p>Handle the power cord with care.</p> <p>Damaging the cord could lead to fire or electric shock.</p> <ul style="list-style-type: none"><li>• Do not place heavy objects on the cord.</li><li>• Do not place the cord under the product.</li><li>• Do not cover the cord with a rug, etc.</li><li>• Do not scratch or modify the cord.</li><li>• Do not bend, twist or pull the cord with excessive force.</li><li>• Do not apply heat to the cord.</li></ul> <p>If the cord gets damaged (exposed core wires, broken wires, etc.), turn off the product's power, then unplug the power cord from the power outlet. Ask your dealer to replace it.</p>
5	 PROHIBITED	<p>Do not touch the power plug if you hear thunder.</p> <p>Doing so could result in electric shock.</p>
6	 REQUIRED	<p>Please use the power cord provided with this product in accordance with the power cord table.</p> <p>If a power cord is not supplied with this product, please contact us. For all other cases, please use the power cord with the plug style that matches the power socket where the product is located.</p> <p>The compatible power cord corresponds to the AC voltage of the power outlet and has been approved by, and complies with, the safety standards in the country of purchase.</p>
7	 REQUIRED  PROHIBITED	<p>Please install the product in accordance with the following information.</p> <p>When transporting, moving, or installing the product, please use as many people as necessary to be able to lift the product without causing personal injury or damage to the product.</p> <p>Please refer to the instructions included with the optional mounting equipment for detailed information about attaching or removing.</p> <p>Do not cover the vent on the product. Improper installation of the product may result in damage to the product, an electric shock or fire.</p> <p>Do not install the product in the locations below:</p> <ul style="list-style-type: none"><li>• Poorly ventilated spaces.</li><li>• Near a radiator, other heat sources, or in direct sunshine.</li><li>• Continual vibration areas.</li><li>• Humid, dusty, steamy, or oily areas.</li><li>• Outdoors.</li><li>• High-temperature environment where humidity changes rapidly and condensation is likely to occur.</li></ul> <p>Do not mount the product in any configuration or position not described in the user's manual. Please check the Specifications for the available Tilt range when installing the product.</p>


**WARNING**

8	 <b>PROHIBITED</b>   <b>REQUIRED</b>	<p>Prevent tipping and falling for earthquakes or other shocks.</p> <p>To prevent personal injury or damage to the product caused by tipping over due to earthquakes or other shocks, make sure to install the product in a stable location and take measures to prevent falling.</p> <ul style="list-style-type: none"> <li>• The product must be mounted to an approved flexible arm (e.g. TUEV GS mark) or stand that supports the weight of the product to prevent damage and personal injury that could result from the product tipping over or falling.</li> <li>• Only use the screws that were removed from the product's stand or the specified screws to avoid damage to the product or the stand.</li> <li>• Please tighten all screws (Recommended Fasten Force: 98 - 137 N•cm) when installing the product to a flexible arm or stand. A loose screw may cause the product to fall, causing damage to the product or personal injury.</li> <li>• Attaching the flexible arm should be performed by two or more people if the product cannot be placed face-down on a flat surface for installation.</li> </ul> <p>Stability Hazard.</p> <p>The product may fall, causing serious personal injury or death. To prevent injury, this product must be securely attached to the floor/ wall in accordance with the installation instructions. Many injuries, particularly to children, can be avoided by taking simple precautions such as:</p> <ul style="list-style-type: none"> <li>• ALWAYS use stands or installation methods recommended by the manufacturer of the product set.</li> <li>• ALWAYS use furnitures that can safely support the product.</li> <li>• ALWAYS ensure the product is not overhanging the edge of the supporting furniture.</li> <li>• ALWAYS educate children about the dangers of climbing on furniture to reach the product or its controls.</li> <li>• ALWAYS route cords and cables connected to your product so they cannot be tripped over, pulled or grabbed.</li> <li>• NEVER place a product in an unstable location.</li> <li>• NEVER place the product on tall furniture (for example, cupboards or bookcases) without anchoring both the furniture and the product to a suitable support.</li> <li>• NEVER place the product on cloth or other materials that may be located between the product and supporting furniture.</li> <li>• NEVER place items that might tempt children to climb, such as toys and remote controls, on the top of the product or furniture on which the product is placed.</li> <li>• ALWAYS use wall mounting accessories when installing the product at a high location. NEVER place the product on a monitor stand when installing the product at a high location.</li> </ul> <p>If the existing product is going to be retained and relocated, the same considerations as above should be applied.</p>
9	 <b>PROHIBITED</b>	<p>Do not place this product on a sloping or unstable cart, stand or table.</p> <p>Doing so could lead to falling or tipping and cause personal injury.</p>
10	 <b>PROHIBITED</b>   <b>HAZARDOUS VOLTAGE</b>	<p>Do not insert objects of any kind into the cabinet slots.</p> <p>It may cause electric shock, fire, or product failure. Keep objects away from children and babies.</p> <p>If objects get into the cabinet slot, turn off the product's power, then unplug the power cord from the power outlet. Contact your dealer for repairs.</p>













## WARNING









11	 DO NOT WET	Do not spill any liquids into the cabinet or use your product near water. Immediately turn off the power and unplug your product from the wall outlet, then refer servicing to qualified service personnel. It may cause an electric shock or start a fire.
12	 PROHIBITED	Do not use flammable gas sprays to remove dust when cleaning the product. Doing so could lead to a fire.
13	 PROHIBITED	Usage of the product must not be accompanied by fatal risks or dangers that, could lead directly to death, personal injury, severe physical damage or other loss, including nuclear reaction control in nuclear facility, medical life support system, and missile launch control in a weapon system.



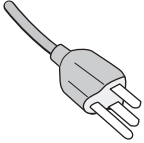
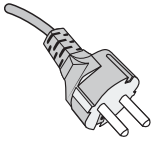
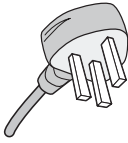
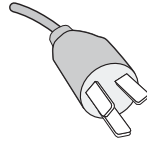
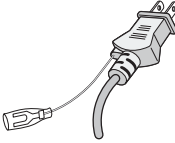

**CAUTION**

1	 <b>REQUIRED</b>  <b>DO NOT TOUCH WITH WET HANDS</b>  <b>UNPLUG THE POWER CORD</b>  <b>HAZARDOUS VOLTAGE</b>	<p>Handling the power cord.</p> <p>Handle the power cord with care. Damaging the cord could lead to fire or electric shock.</p> <ul style="list-style-type: none"> <li>When connecting the power cord to the product's AC IN terminal, make sure the connector is fully and firmly inserted.</li> <li>Make sure the power cord cannot be easily disconnected.</li> <li>Do not connect or disconnect the power cord with wet hands.</li> <li>When connecting or disconnecting the power cord, pull the power cord out by holding onto its plug.</li> <li>When cleaning the product, for safety purposes, unplug the power cord from the power outlet beforehand. Regularly dust off the power cord by using a soft dry cloth.</li> <li>Before moving the product, make sure the monitor power is off, then unplug the power cord from the power outlet and check that all cables connecting the product to other devices are disconnected.</li> <li>When you are not planning to use the product for an extended period of time, always unplug the power cord from the power outlet.</li> <li>This equipment is designed to be used in the condition of the power cord connected to the earth. If the power cord is not connected to the earth, it may cause electric shock. Please make sure the power cord is connected to the wall outlet directly and earthed properly. Do not use a 2-pin plug converter adapter.</li> </ul>
2	 <b>REQUIRED</b>	<p>Please confirm the distribution system in building installation shall provide the circuit breaker rated 120/240 V, 20 A (maximum).</p>
3	 <b>PROHIBITED</b>  <b>REQUIRED</b>	<p>Do not bind the power cord and the USB cable.</p> <p>It may trap heat and cause a fire.</p>
4	 <b>PROHIBITED</b>	<p>Do not connect to a LAN with excessive voltage.</p> <p>When using a LAN cable, do not connect to a peripheral device with wiring that might have excessive voltage. Excessive voltage on the LAN port may cause an electric shock.</p>
5	 <b>PROHIBITED</b>	<p>Do not climb on the table where the product is installed. Do not install the product on a wheeled table if the wheels on the table have not been properly locked. The monitor may fall, causing damage to the product or personal injury.</p>
6	 <b>REQUIRED</b>	<p>Installation, removal, and adjustment of the stand.</p> <ul style="list-style-type: none"> <li>Handle with care when pulling the stand as it might pinch your fingers.</li> <li>Please securely hold the monitor stand while removing the screws to prevent the monitor stand from falling. It may cause personal injury.</li> <li>Before rotating the screen, disconnect the power cord and all cables from the product. Otherwise, the power cord or cables might pull with excessive force and cause personal injury or damage to the product.</li> <li>When rotating the screen, slide it to the highest level and set it to the maximum tilt. Otherwise, it could cause personal injury or knock the screen on the desk.</li> </ul>

 **CAUTION**

7	 <b>PROHIBITED</b>	<p>Please check the Specifications for the available Tilt range when installing the product on a flexible arm.</p> <p>Do not tilt the monitor downward beyond 5 degrees. Doing so can cause the LCD panel to separate and potentially fall out causing damage to the product or personal injury.</p>
8	 <b>PROHIBITED</b>	<p>Do not push the product.</p> <p>The product may fall, causing damage to the product or personal injury.</p>
9	 <b>PROHIBITED</b>	<p>Do not impact the LCD panel surface, it can cause serious damage to the product or personal injury.</p>
10	 <b>REQUIRED</b>	<p>Suitable for entertainment purposes at controlled luminous environments, to avoid disturbing reflections from the screen.</p>
11	 <b>PROHIBITED</b>	<p>Do not connect headphones to the product while you are wearing them.</p> <p>Depending on the volume level, it may damage your ears and cause loss of hearing.</p>
12	 <b>PROHIBITED</b>	<p>Do not play with the plastic bag which covers the product.</p> <p>Do not use this bag for any other purpose. To avoid the danger of suffocation, do not place this bag over your head, nose or mouth. Do not place this bag over another person's head, nose or mouth.</p> <p>Keep this bag away from children and babies.</p>
13	 <b>REQUIRED</b>	<p>To ensure the product's reliability, please clean the ventilation holes at the rear side of the cabinet at least once a year to remove dirt and dust. Failure to do so could lead to electric shock or damage to the product.</p>
14	 <b>REQUIRED</b>	<p>Avoid locations with extreme temperatures and humidity. Failure to do so could lead to fire or electric shock or damage to the product. The usage environment for this product is as follows:</p> <ul style="list-style-type: none"> <li>• The operating temperature: 5 °C to 35 °C/41 °F to 95 °F/ humidity: 20 to 80% (without condensation)</li> <li>• The storage temperature: -10 °C to 60 °C/14 °F to 140 °F/ humidity: 10 to 85% (without condensation)</li> </ul>

## Power Cord Table

Plug Type	North America	European Continental	U.K.	Chinese	Japanese
Plug Shape					
Region	U.S.A./Canada	EU	U.K.	China	Japan
Voltage	120*	230	230	220	100

\* Please use this power cord under 125 V power supply.

**NOTE:** This product can only be serviced in the country where it was purchased.

### Image Persistence

Image Persistence, also called Image Retention, is a condition that occurs when a previously displayed image leaves a residual or “ghost” impression on the screen. This happens when a single still image is shown for an extended time or when an image tremors or flashes at high speed. This is due to the technology of the LCD module and screen characteristics; it is not a product failure. While a residual image may disappear over time depending on the product usage, there is no guarantee Image Persistence will resolve itself. Please follow these guidelines to care for the product and reduce the chance of Image Persistence occurring:

- NOTE:**
- Do not display images with repeated tremors or flashing at high speeds.
  - Do not display a single still image for an extended period of time.

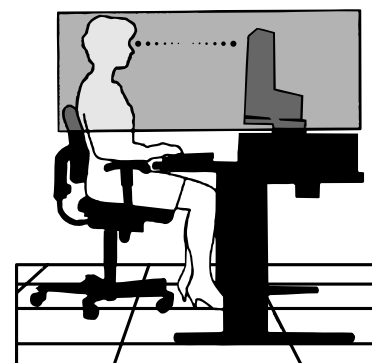
One of the methods to avoid Image Persistence is to frequently switch the displaying image using computer power management or screen savers.

## Ergonomics

CORRECT PLACEMENT AND ADJUSTMENT OF THE MONITOR CAN  
REDUCE EYE, SHOULDER, AND NECK FATIGUE. CHECK THE  
FOLLOWING WHEN YOU POSITION THE MONITOR:

To realize the maximum ergonomics benefits, we recommend the following:

- For optimum performance of the monitor, allow 20 minutes for warming up. Avoid reproduction of still patterns on the monitor for long periods of time to avoid image persistence (after image effects).
- Adjust the monitor height so that the top of the screen is at or slightly below eye level. Your eyes should look slightly downward when viewing the middle of the screen.
- Position your monitor no closer than 40 cm (15.75 inches) and no further away than 70 cm (27.56 inches) from your eyes. The optimal distance is 50 cm (19.69 inches).
- Rest your eyes periodically for 5 to 10 minutes for every 1 hour by focusing on an object at least 20 feet away.
- Position the monitor at a 90° angle to windows and other light sources to minimize glare and reflections. Adjust the monitor tilt so that ceiling lights do not reflect on your screen.
- If reflected light makes it hard for you to see your screen, use an anti-glare filter.
- Adjust the monitor’s brightness and contrast controls to enhance readability.
- Use a document holder placed close to the screen.
- Position whatever you are looking at most of the time (the screen or reference material) directly in front of you to minimize turning your head while you are typing.
- Blink often. Eye exercise helps to reduce eye strain. Please contact your ophthalmologist. Get regular eye checkups.
- To avoid eye fatigue, adjust the brightness to a moderate setting. Place a sheet of white paper next to the LCD screen for luminance reference.
- Do not position the Contrast control to its maximum setting.
- Use the preset Size and Position controls with standard signals.



- Use the preset Color Setting.
- Use non-interlaced signals.
- Do not use primary color blue on a dark background, as it is difficult to see and may produce eye fatigue due to insufficient contrast.

For more detailed information on setting up a healthy work environment, write to the American National Standard for Human Factors Engineering of Computer Workstations - ANSI/HFES 100-2007 - The Human Factors Society, Inc. P.O. Box 1369, Santa Monica, California 90406.

## Cleaning the LCD Screen

- When the LCD Screen is dusty, please gently wipe with a soft cloth.
- Clean the LCD screen surface with a lint-free, non-abrasive cloth. Avoid using any cleaning solution or glass cleaner!
- Please do not rub the LCD Screen with hard or coarse material.
- Please do not apply pressure to the LCD Screen surface.
- Please do not use OA cleaner as it will cause deterioration or discoloration on the LCD Screen surface.

## Cleaning the Cabinet

- Unplug the power supply.
- Gently wipe the cabinet with a soft cloth.
- To clean the cabinet, dampen the cloth with a neutral detergent and water, wipe the cabinet and follow with a dry cloth.

**NOTE:** DO NOT clean with benzene thinner, alkaline detergent, alcoholic system detergent, glass cleaner, wax, polish cleaner, soap powder, or insecticide. Rubber or vinyl should not be in contact with the cabinet for an extended period of time. These types of fluids and materials can cause the paint to deteriorate, crack or peel.

# Product Features

- **Color Control Systems**

Allow you to adjust the colors on your screen and customize the color accuracy of your monitor to a variety of standards.

- **OSD (On-Screen Display) Controls**

Allow you to quickly and easily adjust all elements of your screen image via simple to use on-screen menus.

- **5-Direction-Key**

A 5-way control button on the back with on-screen display (OSD) indicators for easy adjustment of key settings.

- **Productivity**

Provides stable and high-speed data communication by LAN (RJ-45) connection (see [page 14](#)).

Transmits power delivery (60 W), video signal, and audio signal by a USB Type-C cable.

USB Hub provides the connectivity of accessories such as a keyboard and mouse.

- **Multiple signal input**

Full connectivity including DisplayPort, HDMI input, and USB Type-C.

- **Multiple audio input and output options**

Audio input is supported over USB Type-C, DisplayPort, and HDMI.

Internal stereo speakers for audio from the monitor (1W+1W) (see [page 14](#)).

Connector for audio output to headphones (see [page 14](#)).

- **Reduction of power consumption**

Two options for ECO Mode™ allows you to manually adjust the display's brightness to your liking, saving power and reducing your energy costs (see [page 37](#)).

LED backlight technology provides for industry-leading low power consumption and less hazardous materials.

- **Enhance human ergonomics to improve the working environment**

The ergonomic features include a fully articulating monitor stand, OSD controls for quick and easy image adjustment, and lower emissions.

- **Plug and Play**

The Microsoft® solution with the Windows® operating system facilitates setup and installation by allowing the monitor to send its capabilities (such as screen size and resolutions supported) directly to your computer, automatically optimizing display performance.

- **Intelligent Power Manager System**

Provides innovative power-saving methods that allow the monitor to shift to a lower power consumption level when on but not in use, saving two-thirds of your monitor energy costs, reducing emissions, and lessening the air conditioning demands on the workplace.

- **Multiple Frequency Technology**

Automatically adjusts the monitor to the display card's scanning frequency, thus displaying the resolution required.

- **FullScan Capability**

Allows you to use the entire screen area in most resolutions, significantly expanding the image size.

- **VESA Standard Mounting Interface**

Allows you to connect your MultiSync monitor to any VESA standard third party mounting arm or bracket.

- **Low Blue Light**

Low Blue Light function substantially reduces blue light and helps to alleviate eye strain (see [page 37](#)).

- **Flicker Free**

Special backlight system reduces flicker for less eye strain.

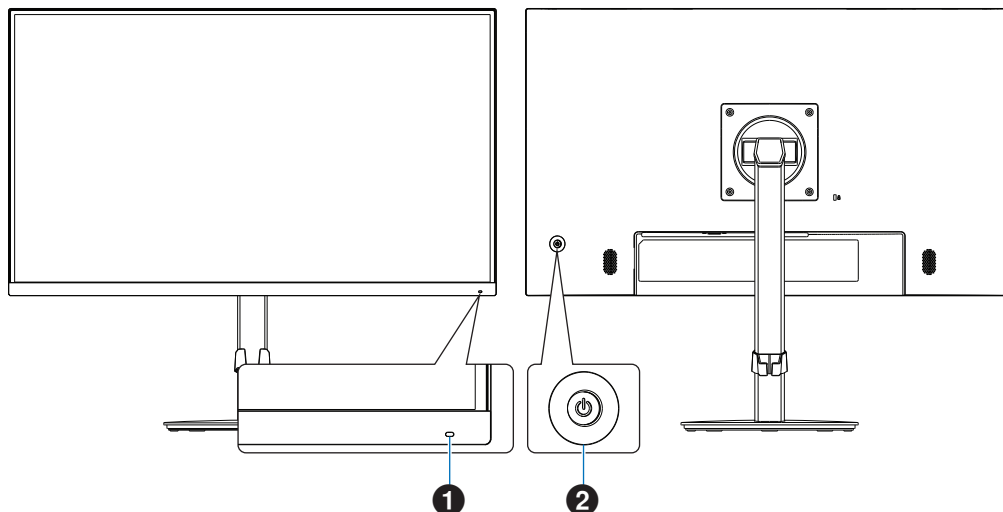
# Chapter 1 Installation and Connections

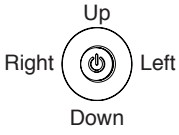
## **This Chapter Includes:**

- ⇒ “Parts Name and Functions” on page 13
- ⇒ “Installation” on page 16
- ⇒ “Connections” on page 17
- ⇒ “Flexible Arm Installation” on page 23

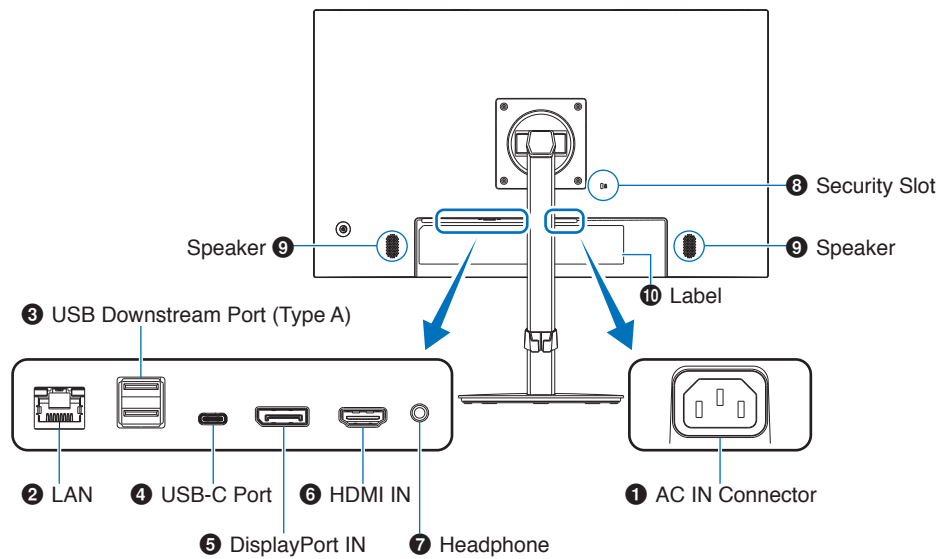
# Parts Name and Functions

## Control Panel



Item		Function
<b>1 LED</b>		Indicates that the power is on or off.
<b>2 5-Direction-Key</b> 	<b>CENTER/⏻</b>	Short press: Turns the monitor on. Long press (three or more seconds): Turns the monitor off.
	<b>LEFT/RIGHT</b>	Opens the OSD menu. RIGHT: Enters sub-menus or adjustment settings in the OSD menu when the OSD menu is open. LEFT: Exits the OSD sub-menus, adjustment settings, and closes the main menu.
	<b>DOWN/UP</b>	Opens the OSD menu. UP: When the OSD menu is open, it navigates to the right or raises settings adjustments. DOWN: When the OSD menu is open, it navigates to the left or lowers settings adjustments.

# Terminal Panel



## 1 AC IN Connector

Connects with the supplied power cord.

## 2 LAN Port IN (RJ-45)

This monitor is equipped with a LAN-to-USB conversion function. Through the USB port, a connected computer can access the monitor's LAN connection. By connecting with the USB port, you can create a stable network environment even if the connected computer is not equipped with LAN ports.

**NOTE:** LED on the side of LAN port lits when a LAN cable is connect to the monitor.

Connected: Steady green LED.

Communicating: Blinking amber LED.

## 3 USB Downstream Port (Type-A)

Connects with USB devices.

## 4 USB-C Port

Connects with USB Type-C® compliant external equipment such as a computer. Charges a connected USB device (USB Power Delivery). See "[Specifications](#)" page.

**NOTE:**

- Supports DisplayPort signals input when a connected USB-C device complies with USB Power Delivery.
- Functions as a USB hub.
- Provides power delivery to a connected device when the function is enabled in the OSD ([USB Functionality] must be set to [Auto] or [On]).

## 5 DisplayPort IN

Digital DisplayPort signals input.

## 6 HDMI IN

Digital HDMI signals input.

## 7 Headphone Jack

Connects with headphones.

The audio out signal is always routed to the headphone jack when headphones are connected to the monitor; there is no sound from the monitor speakers.

## 8 Security Slot

Security and theft protection lock slot compatible with Kensington security cables/equipment.

For products visit Kensington's website.

## 9 Speaker

## 10 Label

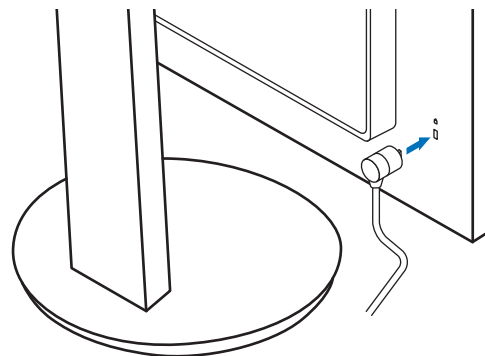


## Installing a security cable

As a security measure, you can secure the monitor to a fixed object with an optional security cable.

Please follow the security cable supplier's recommended instructions to install.

**NOTE:** A security cable (purchased separately) is designed as a deterrent, it is not guaranteed to prevent the device from being mishandled or stolen.



# Installation

For box contents, please refer to the printed contents sheet or setup manual provided in the box.  
The accessories included depends on the location where the monitor was shipped.

## Attach the base to the LCD monitor stand

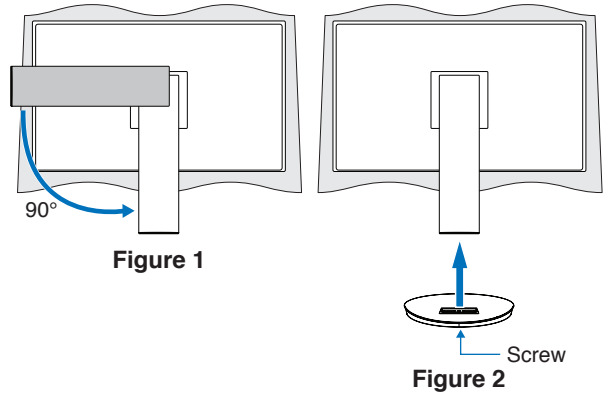
1. Place the monitor face down on a non-abrasive surface (**Figure 1**).
2. Please rotate the monitor stand 90 degrees as shown in **Figure 1**.

**CAUTION:** Please refer to “CAUTION 6”.

3. Attach the base to the stand, then tighten the screw at the base’s bottom (**Figure 2**).

**NOTE:** Reverse this procedure if you need to re-pack the monitor.

**WARNING:** Please refer to “WARNING 8”.



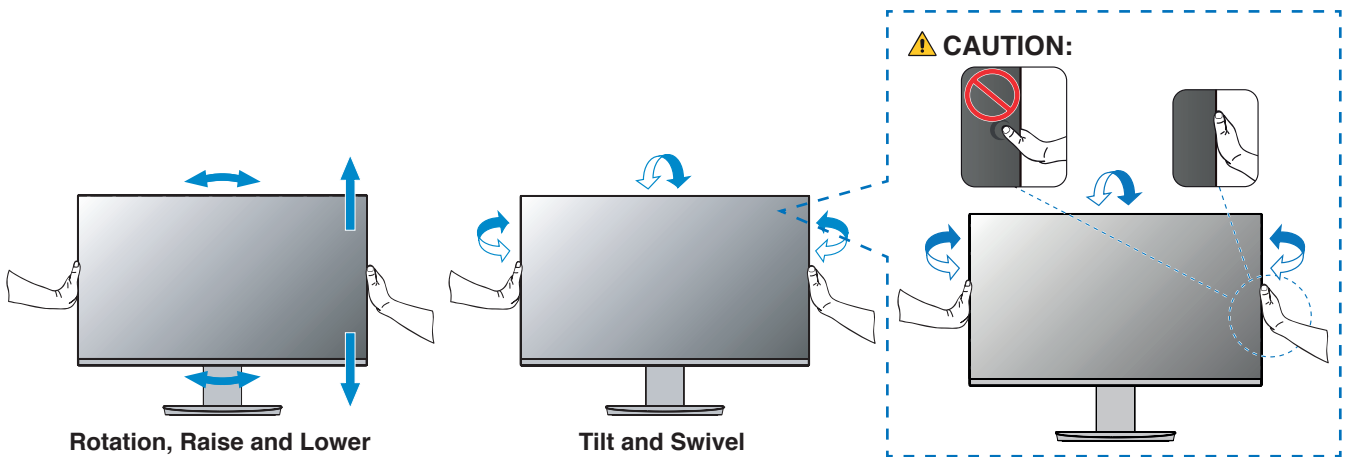
## Connect the power cord and signal cables

Please connect the power cord and signal cables to the monitor (see [page 14](#)).

## Adjustable Stand with Pivot Capability

Hold the monitor on each side and adjust the screen position as desired.

For screen rotation (pivot), hold the monitor on each side, lift to its maximum height and turn it from landscape to portrait.



**CAUTION:** Please refer to “CAUTION 6” and “CAUTION 9”.

# Connections

1. Place your hands on each side of the monitor to tilt the panel to a maximum tilt angle and lift up to the highest position (Figure 3).

**⚠ CAUTION:** Please refer to “CAUTION 6”.

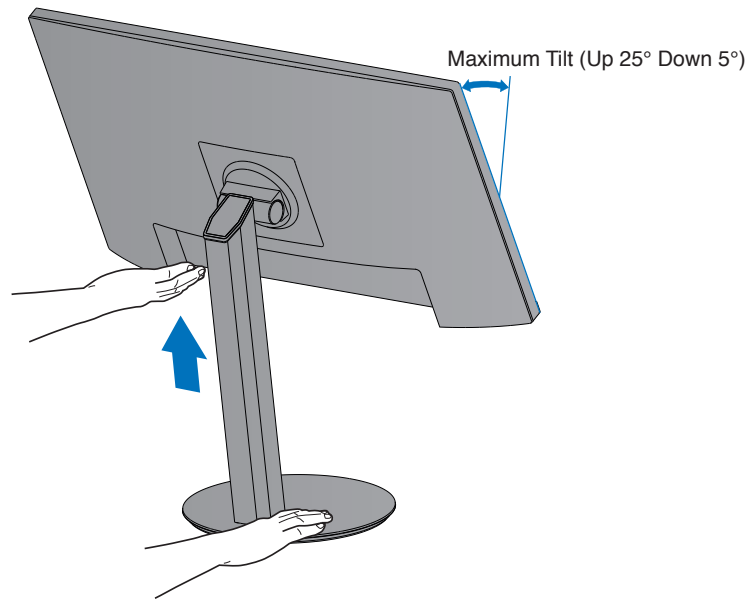
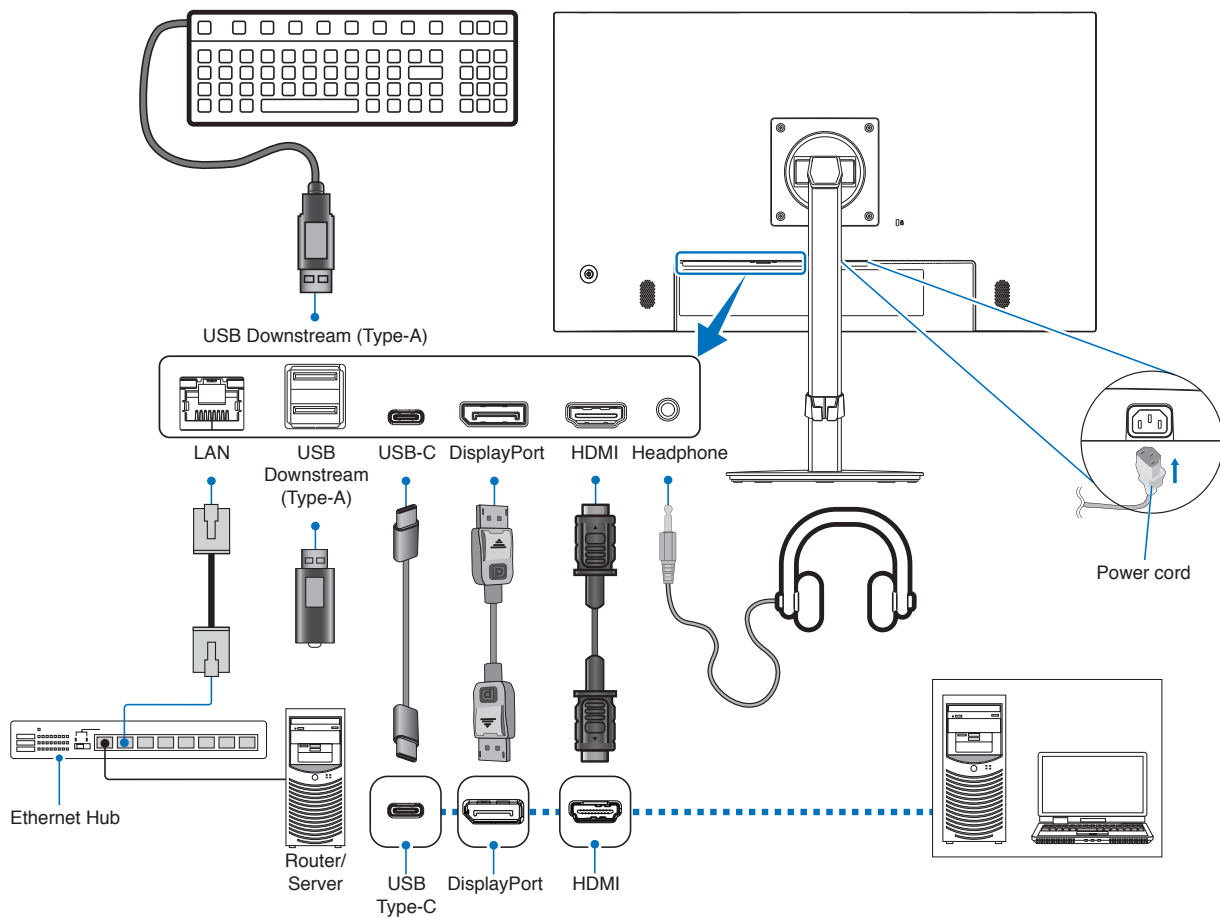


Figure 3

2. Connect devices to the monitor.  
Turn off the power to your computer.



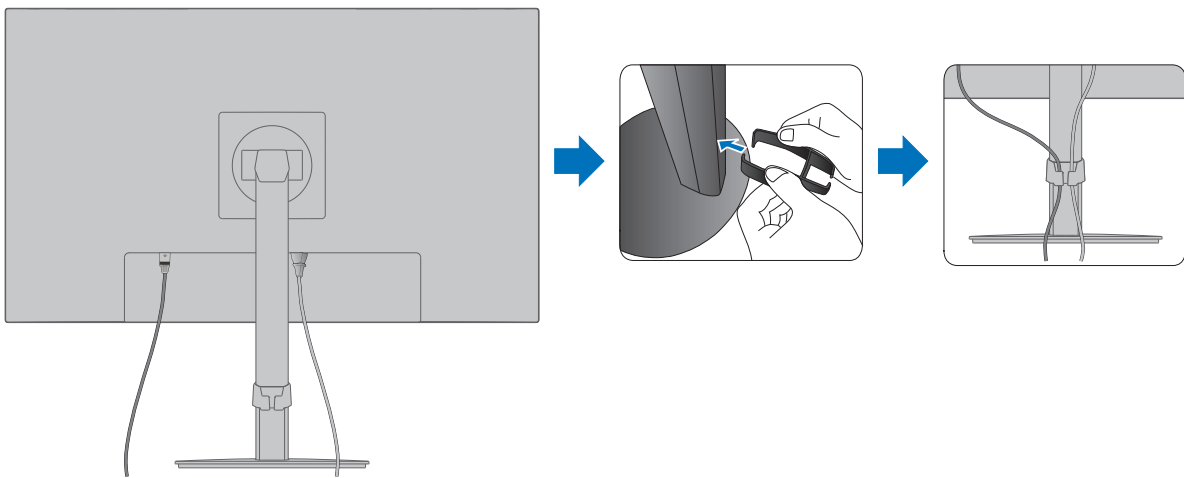
**CAUTION:** • Use the provided specified cables with this product so as not to interfere with radio and television reception.  
For HDMI, DisplayPort, USB and USB-C®, please use a shielded signal cable.  
Use of other cables and adapters may cause interference with radio and television reception.

**⚠ CAUTION:** Please refer to “CAUTION 3” and “CAUTION 11”.

**NOTE:** • Adjustment of the volume control as well as the equalizer to other settings than the center position may increase the ear-/headphones output voltage and therefore the sound pressure level.  
• Incorrect cable connections may result in irregular operation, damage display quality/components of the LCD module and/or shorten the module’s life.  
• Make sure the signal cable is fully connected to the monitor and the computer.  
• There can only be one audio source for the speakers. The audio source is via the video input when using the DisplayPort or HDMI inputs. Sound from devices connected to the Audio IN terminal cannot be output to the speakers in those circumstances.

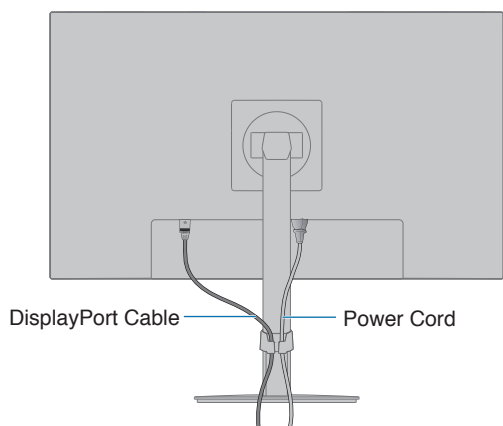
3. Place the cable holder onto the stand (**Figure 4**).

Place the cables in the cable holder firmly and evenly.

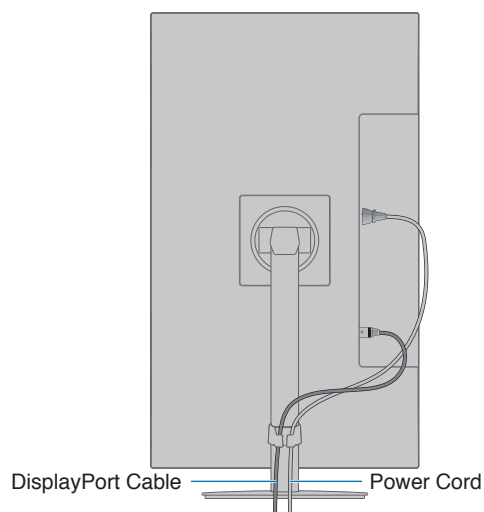


**Figure 4**

4. Please check that you can still rotate, raise and lower the monitor screen after you have installed the cables (**Figure 5** and **Figure 6**).



**Figure 5**




**Figure 6**

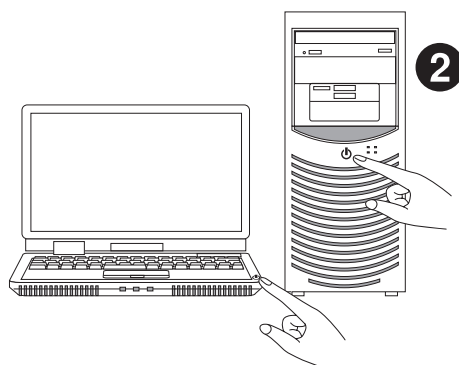
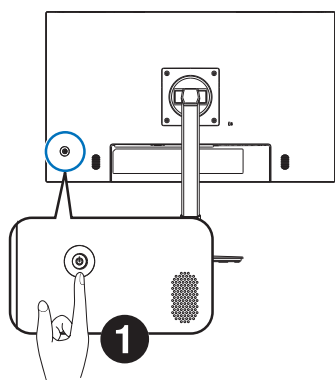
5. Connect the power cord to a power outlet.

**NOTE:**

- Please refer to the Caution section of this manual for proper selection of the AC power cord (see [page 9](#)).
- Please make sure that enough power is supplied to the monitor. Please refer to “Power Supply” in the “Chapter 4 Specifications” on [page 32](#).

6. Turn on the monitor by pressing the  button and then turn on the computer. Please make sure the LED on the front of the monitor is lit.

**NOTE:** If you have any problems please refer to the Troubleshooting section of this User’s Manual (see [page 28](#)).



# Signal type and terminal connection

## Video Input Connections

- HDMI – High definition digital video and audio signal connection to a computer, streaming media player, Blu-ray player, game console, etc.
- DisplayPort – High definition digital video and audio signal connection to a computer.
- USB-C – Supports DisplayPort input of high-definition digital video and audio signal (DisplayPort Alt Mode on USB Type-C only) connection to a computer.

**NOTE:** This monitor does not support other USB Type-C Alt Modes such as MHL and HDMI. This port is not for use with USB devices such as mouse, keyboards, or storage media.

Depending on the computer, you may need to manually set the computer's audio to output through the DisplayPort, HDMI, or USB-C connection. Please refer to the computer's user manual.

The type of video connections that can be used to connect to a computer depends on the computer's display adapter.

The following table shows the typical factory preset signal timing for each connection type. Some display cards may not be able to support the required resolution for proper image reproduction with the selected connection. The monitor will show the proper image by automatically adjusting the factory preset timing signal.

<Major supported timings>

Resolution		Vertical Frequency	Notes
H	V		
640	x 480	60 Hz	
720	x 480	60 Hz	
720	x 576	50 Hz	
800	x 600	56/60 Hz	SVGA
1024	x 768	60 Hz	XGA
1280	x 720	50/60 Hz	720p
1280	x 960	60 Hz	
1280	x 1024	60 Hz	SXGA
1440	x 900	60 Hz	
1680	x 1050	60 Hz	
1920	x 1080	50/60 Hz	1080p, Recommended (60 Hz)

Interlace signal is not supported.

**NOTE:** When the selected monitor resolution is not a native panel resolution, the text contents appearance in the monitor screen is expanded in a horizontal or vertical direction to show the non-native resolution to full screen. This expansion is done by interpolated resolution technologies, which are normal and widely used in flat panel devices.

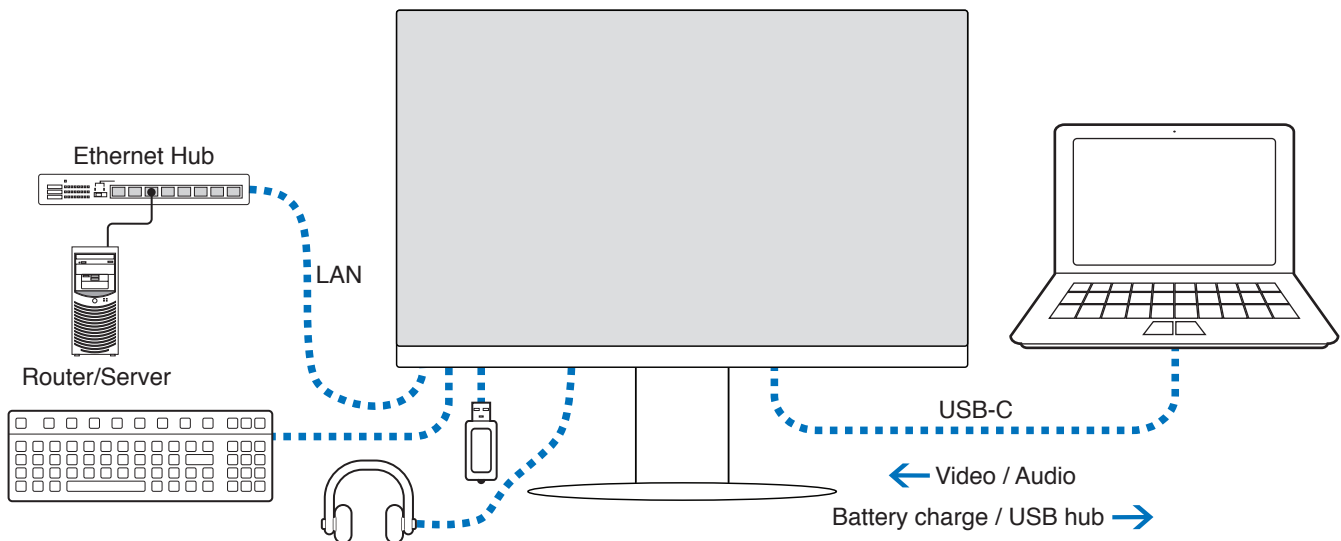
## Connecting to a Computer with HDMI

- Please use an HDMI cable with the HDMI logo.
- It may take a moment for the signal to appear after turning on the computer.
- Some display cards or drivers may not display an image correctly.
- If the monitor's power is turned on after a connected computer is turned on, sometimes an image is not displayed. In this case, please turn off the computer then turn it on again.

## Connecting to a Computer with DisplayPort

- Please use a certified DisplayPort cable.
- It may take a moment for the signal to appear after turning on the computer.
- When connecting a DisplayPort cable to a component with a signal conversion adapter, an image may not appear.
- Some DisplayPort cables feature a locking function. When removing this cable, hold down the top button to release the lock.
- If the monitor's power is turned on after a connected computer is turned on, sometimes an image is not displayed. In this case, please turn off the computer then turn it on again.

## Connecting to a Computer with USB Type-C



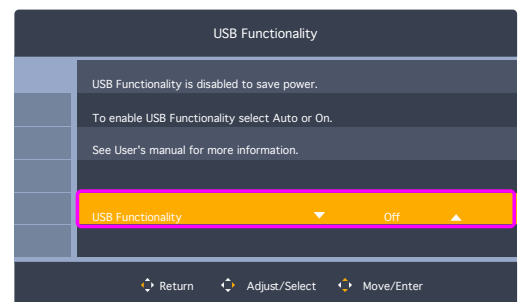
- When using the USB-C port for video / audio, please use a SuperSpeed USB cable with the USB compliance logo.
- Hi-Speed USB (USB 2.0) cable or charging cable doesn't support video / audio transmission.
- When using the USB-C port for video / audio, please use a computer port that supports the DP Alt Mode.
- HDMI Alt Mode or MHL is not supported.
- When using computer battery charging (Power delivery), please use a computer and cable that support the USB Power Delivery.
- It may take a few seconds for the monitor to recognize the USB signal. Do not disconnect or reconnect the USB cable while the signal is being recognized.

Please adjust the screen position by referring to “Adjustable Stand with Pivot Capability”.

## Recovering from no image

If the monitors do not display an image, please follow the instructions below:

1. Turn off the computer.
2. Turn off the monitor by pressing the center of the 5-direction key for 3 or more seconds (see [page 13](#)).
3. Turn on the monitor by pressing the center of the key again.
4. When the USB Functionality message appears on-screen, press the key up/down to select [Auto] or [On].
5. Press the key to the left to close the message.
6. Turn on the computer.



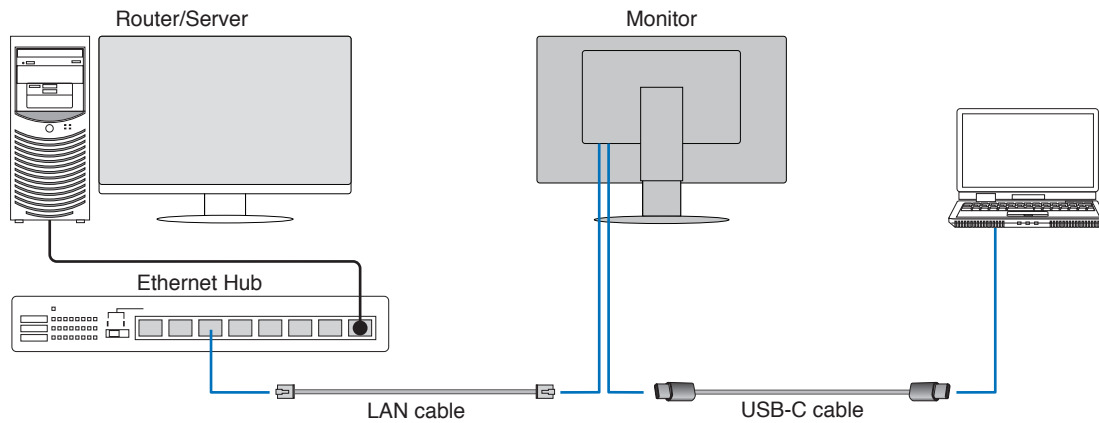
# Connecting devices

## Connecting USB Devices

- It may take a few seconds for the monitor to recognize the USB input. Do not disconnect the USB cable or disconnect and reconnect the USB cable before the monitor recognizes the input.
- Before turning off the power switch of the monitor or shutting down Windows®, please turn off the USB function and remove the USB device from the monitor. Data may be lost or corrupted if the USB device is not disconnected properly.

## LAN connection

Example of LAN connection:



### Preparation Before Use

- Connect the monitor to the computer via a USB Type-C cable when connecting a LAN cable to the monitor (as shown above).
- The standard driver is installed automatically. Depending on the computer or OS, a manual driver installation may be required (see [page 31](#)).
- Please set the OSD Menu option [USB Functionality] to [On].
- Please set the OSD Menu option [USB LAN] to [On].
- After connecting a LAN cable to the monitor, make sure the LED on the side of the LAN port lights up.
- This monitor supports 1000 Mbps communication. Please make sure to use a compatible LAN cable when connecting to a 1000 Mbps network.
- LAN-to-USB conversion may not work and depends on the computer and its operating system. Any devices connected to the monitor or computer may cause interference. Make sure to use a compatible USB Type-C cable that transmits LAN signal; e.g., a power delivery only or USB 2.0 cable will not work.
- If LAN-to-USB conversion does not work, check if the connected computer supports LAN communication over USB. Refer to the computer’s product manual for additional information.

OSD	USB Functionality	Auto			On			Off								
	USB LAN	On			On			Disable								
Power	Power state	ON	PSM	OFF	ON	PSM	OFF	ON	PSM	OFF						
	Power LED	Blue	Amber	OFF	Blue	Amber	OFF	Blue	Amber	OFF						
USB	Power Delivery	Enable			OFF			Disable								
	HUB										OFF			Enable		
	LAN										OFF			Enable		

PSM is an abbreviation of power save mode.



## Flexible Arm Installation

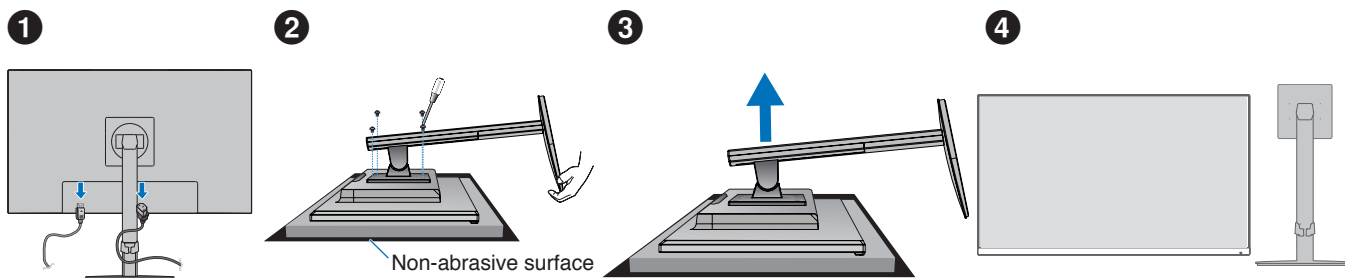
This monitor is designed for use with a flexible arm. Contact us for more information.

Follow the instructions provided by the manufacturer of the display mount. Use only VESA-compatible alternative mounting method. Remove the monitor stand before mounting.

**⚠ WARNING:** Please refer to “[WARNING 8](#)”. See the Specifications on [page 32](#) for details.

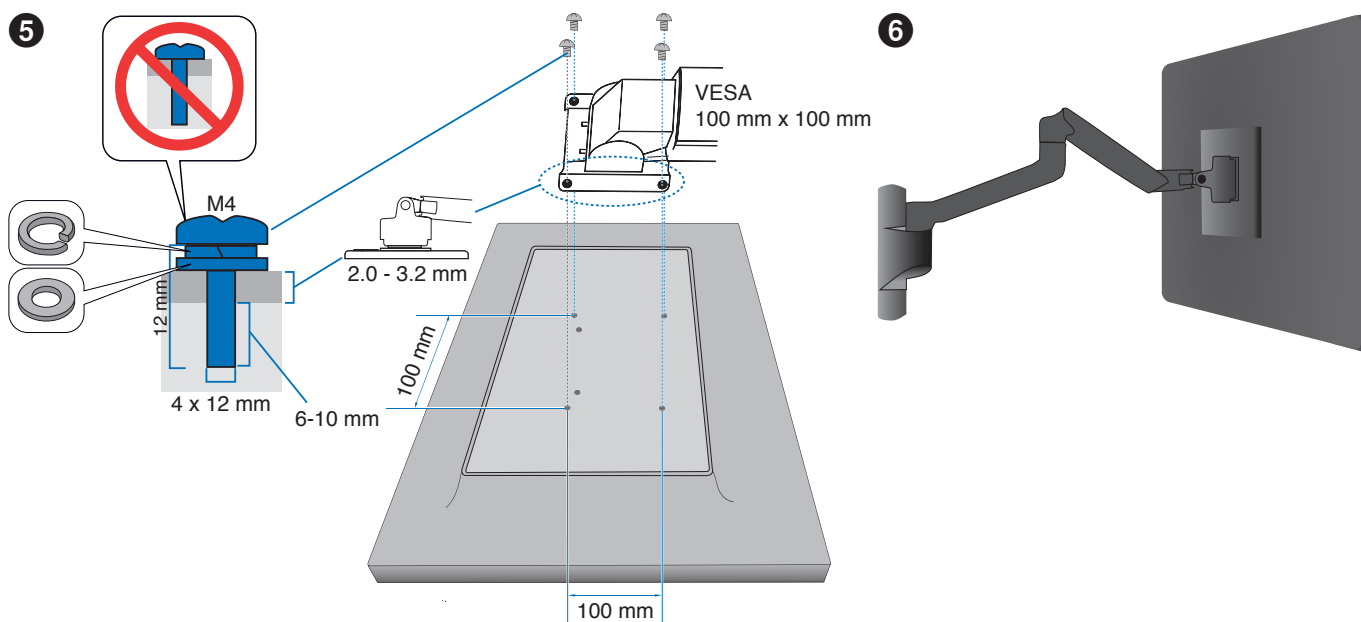
### Remove the Monitor Stand for Mounting

**NOTE:** Handle with care when removing the monitor stand.



### Mount the Flexible Arm

Using four screws that meet the specifications listed below, attach the arm to the monitor.

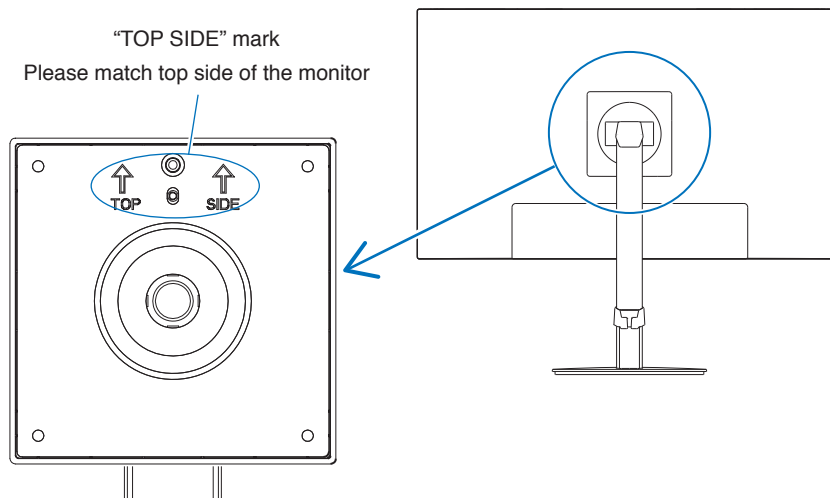


**⚠ WARNING:** Please refer to “[CAUTION 7](#)”.

## Re-attaching the Original Stand

Reverse the process in the previous section to re-attach stand.

**NOTE:** Match "TOP SIDE" mark on stand to top side of the monitor when re-attaching stand.



## Chapter 2 Basic Operation

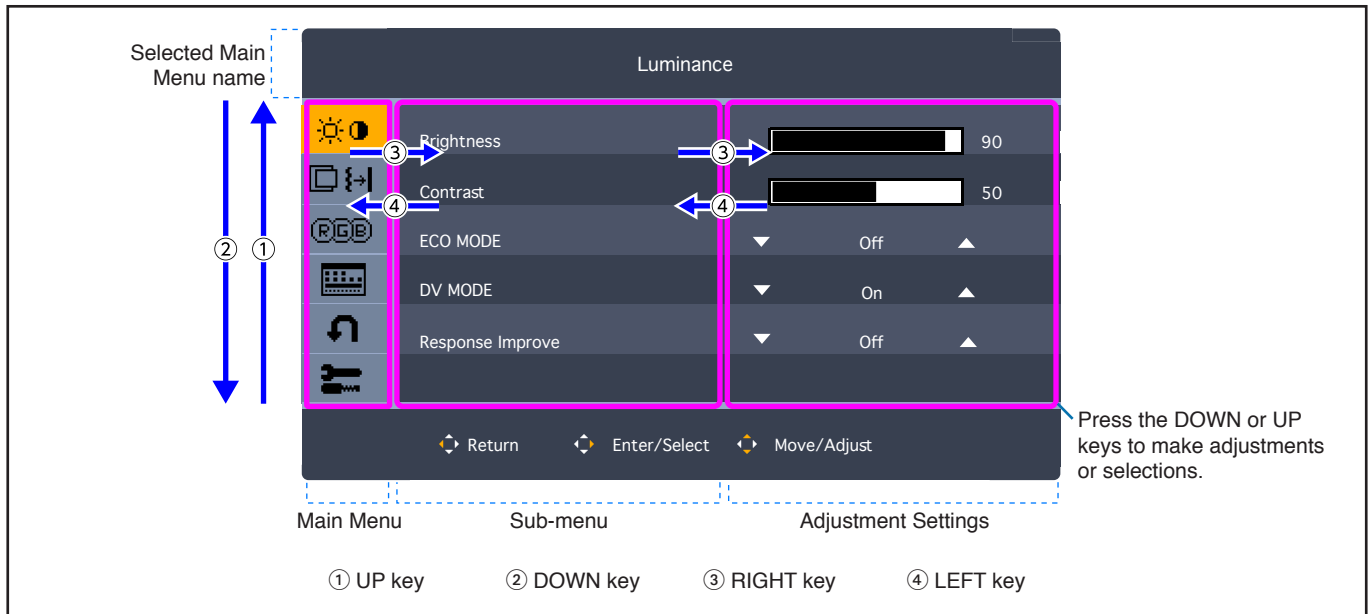
### **This Chapter Includes:**

- ⇒ “Using the OSD (On-Screen Display) Controls” on page 26
- ⇒ “Changing the Input” on page 27
- ⇒ “Power management function LED indicator patterns” on page 27

# Using the OSD (On-Screen Display) Controls

## The OSD (On-Screen Display) control button on the front of the monitor functions as follows:

- To open the OSD menu, move the 5-direction key in any direction (LEFT/RIGHT/UP/DOWN).



Below is a brief summary of where controls are under each menu item. Tables listing all options available in the OSD menu are located in [“Appendix A OSD Controls List” on page 36](#).

**Luminance:** Brightness and Eco Mode settings.

**Image Setup:** Screen adjustment settings.

**Color Setup:** Color settings.

**OSD Setup:** OSD menu settings.

**System Setup:** Factory reset, etc.

**Extra:** Input and audio settings.

# Changing the Input

## Changing the Input

To change the signal input, open the OSD menu by moving the 5-direction key in any direction (LEFT/RIGHT/UP/DOWN). You can select the input signal at [Input Select] under the [Extra].

**NOTE:** When selecting [Auto] input, the monitor selects the active signal input automatically.

### For HDCP Content

HDCP is a system for preventing illegal copying of video data sent over a digital signal. If you are unable to view material via the digital inputs, this does not necessarily mean that the monitor is not functioning properly. With the implementation of HDCP, there may be cases in which certain content is protected by HDCP and might not be displayed due to the decision/intention of the HDCP community (Digital Content Protection, LLC). HDCP video content is generally commercially produced Blu-rays and DVDs, television broadcast, and streaming media services.

## Power management function LED indicator patterns

The power management function is an energy saving feature that automatically reduces the power consumption of the monitor when the keyboard or the mouse has not been used for a fixed period.

Mode	LED indicator	Power consumption	Condition
Maximum operation	Blue	Approx. 93 W (E224FL) Approx. 98 W (E244FL) Approx. 100 W (E274FL)	All functions work.
Normal operation	Blue	Approx. 16 W* <sup>1</sup> (E224FL) Approx. 19 W* <sup>1</sup> (E244FL) Approx. 20 W* <sup>1</sup> (E274FL)	Default setting.
Energy saving mode	Amber	0.50 W* <sup>1</sup>	The monitor has passed a certain amount of time with no video signal input.
Off mode	Off	0.30 W* <sup>1</sup>	Turn off the monitor by the ⏻ key.

\*<sup>1</sup>: Power consumption depends on the OSD menu setting or which devices are connected to the monitor.

**NOTE:** This function works with computers that support VESA approved DPM (Display Power Management).

# Chapter 3 Troubleshooting

## **This Chapter Includes:**

- ⇒ “Screen Image and Video Signal Issues” on page 29
- ⇒ “Hardware Issues” on page 30

# Screen Image and Video Signal Issues

---

## No picture

- Make sure the signal cable is fully connected to the monitor and the computer.
- Make sure there is no DisplayPort converter adapter connected. The monitor does not support DisplayPort converter adapters.
- Make sure the computer's display card is fully seated in its slot.
- Make sure both the computer and monitor are powered on.
- Make sure that a supported resolution has been selected on the display card or system being used. If in doubt, please refer to the user's manual of the display controller or system to change the resolution.
- Check the monitor and your display card with respect to compatibility and recommended signal timings.
- Check the signal cable connector for bent or pushed-in pins.
- The monitor may be in power saving mode. The monitor automatically goes into standby at the preset time period after the video signal is lost.
- Make sure the connected device outputs a signal to the monitor.
- When using a USB-C cable for connecting a computer to the monitor, please check that the connected computer's port complies with DisplayPort Alt Mode.
- When using a USB-C cable for connecting a computer to the monitor, check that the USB-C cable complies with SuperSpeed USB.

## Image Persistence

- If a ghost or residual image occurs, please check Image Persistence (see [page 9](#)).

## The image is unstable, unfocused or swimming is apparent

- Make sure the signal cable is fully connected to the monitor and the computer.
- Check the monitor and your display card with respect to compatibility and recommended signal timings.

## Picture is not bright

- Make sure [ECO MODE] is [Off].
- Make sure the signal cable is fully connected to the monitor and the computer.
- LCD brightness degradation occurs due to long-term usage or extreme cold conditions.
- If the brightness fluctuates, make sure [DV MODE] is set to [Off]. Please refer to "OSD Warning" on [page 38](#).

## Selected resolution is not displayed properly

- If the resolution you set is over or under a range, "Out Of Range" window will appear then warn you. Please set supported resolution at the connected computer.

## Brightness variations over time

- Change [DV MODE] to [Off] and adjust brightness. Please refer to "OSD Warning" on [page 38](#).

**NOTE:** When [DV MODE] is set to [On], the monitor automatically adjusts brightness based on the video signal.

# Hardware Issues

---

## **⏻ key does not respond**

- Unplug the power cord of the monitor from the AC outlet to turn off and reset the monitor.

## **LED on monitor is not lit**

- Make sure the power cord is properly connected to the monitor and the wall, and make sure the monitor's power switch is on.

## **No Video**

- If no video is present on the screen, turn the ⏻ key off for 3 seconds or more and on again.
- Make sure the computer is not in a power-saving mode by touching the connected keyboard or the connected mouse.
- When using DisplayPort, some display cards do not output video signal under low resolution modes when the monitor is turned OFF/ON or disconnected/connected from the AC power cord.
- Make sure [USB Functionality] is set to [Auto] or [On] (see [page 38](#)).

## **No Sound**

- Check to see if [Audio Mute] is activated.
- Check to see if [Audio Volume] is set to a minimum.
- Check to see if the computer supports an audio signal through DisplayPort, HDMI or USB-C.
- Check to see if the headphones cable is properly connected when using headphones.
- Check to see if headphones are connected if not using headphones.

## **The USB Hub does not operate**

- Check to make sure that the USB cable is properly connected. Refer to your USB device User's Manual.
- Check that the USB upstream port on the monitor is connected to the USB downstream port on the computer, and make sure the computer is ON.
- Make sure the USB-C cable is properly connected.
- Check the [USB Functionality] settings (see [page 38](#)).
- Turn the power switch off and on again.

## **No picture**

- Make sure [USB Functionality] is set to [Auto] or [On] (see [page 38](#)). Please refer to "[Recovering from no image](#)" on [page 21](#).
- Check if the connected USB-C device complies with DisplayPort Alt Mode on USB Type-C.
- Check if the USB-C cable complies with SuperSpeed USB.

## **Charging is not started or unstable.**

- Make sure [USB Functionality] is set to [On] (see [page 38](#)).
- Check if the connected USB-C device complies with USB Power Delivery.
- Check if the USB-C cable complies with USB Power Delivery.
- The monitor might have excessive voltage or over current on USB-C port. Please remove the USB-C cable immediately.
- If you still have trouble, unplug the monitor's power cord from the AC outlet and then remove the USB-C cable. Reconnect the power cord and then the USB-C cable.



**LAN port does not work**

- When applying 1000 Mbps communication, please use a compatible LAN cable.
- Make sure a computer is connected to the monitor with a USB-C cable.
- Make sure the LED lights up when connecting a LAN cable to the monitor.
- Please refer to the Terminal Panel (see [page 14](#)) for information about the LAN port's LEDs states.
- Check if [USB Functionality] is set to [Auto] or [On].
- Check if [USB LAN] is set to [On].
- Make sure the driver is installed.
- Depending on the computer or OS, a manual driver installation may be needed. For the latest driver update, please visit ASIX website and download desired file from "AX88179A Software and Tools".

## Chapter 4 Specifications

### **This Chapter Includes:**

- ⇒ “E224FL” on page 33
- ⇒ “E244FL” on page 34
- ⇒ “E274FL” on page 35

# E224FL

Monitor Specifications		MultiSync E224FL	Notes
LCD Module	Diagonal: Viewable Image Size: Native Resolution:	54.48 cm / 21.45 inches 54.48 cm / 21.45 inches 1920 x 1080 60 Hz	Active matrix; thin film transistor (TFT) liquid crystal display (LCD); 0.249 mm (H) x 0.241 mm (V) dot pitch; 250 cd/m <sup>2</sup> white luminance; 3000:1 contrast ratio (typical), (30000:1 Contrast ratio, DV MODE ON).
Input Signal			
DisplayPort:	DisplayPort Connector:	Digital RGB	Up to 1920 x 1080 60 Hz, 8 bit, DisplayPort V1.2 (HDCP 1.3)
	USB-C Port:	Digital RGB	Up to 1920 x 1080 60 Hz, 8 bit, DisplayPort V1.2 (HDCP 1.3)
HDMI:	HDMI Connector:	Digital RGB / YUV	Up to 1920 x 1080 60 Hz, HDMI (HDCP 1.4)
Display Colors		16777216	Depends on display card used.
Synchronization Range	Horizontal: Vertical:	31.5 kHz to 81.1 kHz 50 Hz to 75 Hz	Automatically Automatically
Viewing Angle	Left/Right: Up/Down:	±89° (CR > 10) ±89° (CR > 10)	
Response Time		6 ms (Gray to Gray Typ.)	
Active Display Area	Landscape: Horiz.: Vert.: Portrait: Horiz.: Vert.:	478.7 mm / 18.8 inches 260.3 mm / 10.2 inches 260.3 mm / 10.2 inches 478.7 mm / 18.8 inches	
USB Hub	I/F: Port: Load Current:	SuperSpeed USB 5Gbps Upstream 1 (USB-C Port) Downstream 2 Downstream Port: DC 5 V/0.9 A (Max.) USB-C Port: 60 W (DC 20 V/3 A) (Max.)	
LAN		RJ-45 10 BASE-T/100 BASE-TX/1000 BASE-T	
AUDIO			
AUDIO Input:	DisplayPort Connector: USB-C Port (DisplayPort Alt. Mode): HDMI Connector:	Digital Audio Digital Audio Digital Audio	PCM 2ch 32, 44.1, 48 kHz (16/20/24bit) PCM 2ch 32, 44.1, 48 kHz (16/20/24bit) PCM 2ch 32, 44.1, 48 kHz (16/20/24bit)
Headphone Output: STEREO Mini Jack:			Headphone Impedance 32 Ohm
Speakers	Practical Audio Output:	1.0 W+ 1.0 W	
Power Supply		AC 100-240 V, 50/60 Hz	
Current Rating		1.6 - 0.7 A	
Dimensions	Landscape: Portrait:	493.2 mm (W) x 363.4 – 483.4 mm (H) x 233.2 mm (D) 19.4 inches (W) x 14.3 – 19.0 inches (H) x 9.2 inches (D) 285.3 mm (W) x 506.9 – 587.3 mm (H) x 233.2 mm (D) 11.2 inches (W) x 20.0 – 23.1 inches (H) x 9.2 inches (D)	
Stand adjustable range	Height Adjustment: Tilt / Pivot / Swivel:	120 mm / 4.7 inches (Landscape orientation) 80.4 mm / 3.2 inches (Portrait orientation) Up 25° Down 5° / ± 90° / ± 170°	
Weight		Approx. 5.5 kg (12.1 lbs) (with monitor stand)/ Approx. 3.4 kg (7.5 lbs) (without monitor stand)	
Environmental Considerations			
Operating Temperature:		5°C to 35°C / 41°F to 95°F	
Humidity:		20% to 80%	
Altitude:		16,404 Feet or less / 5,000 m or less	
Storage Temperature:		-10°C to 60°C / 14°F to 140°F	
Humidity:		10% to 85%	
Altitude:		40,000 Feet or less / 12,192 m or less	

**NOTE:** Technical specifications are subject to change without notice.

# E244FL

Monitor Specifications		MultiSync E244FL	Notes
LCD Module	Diagonal: Viewable Image Size: Native Resolution:	60.47 cm / 23.8 inches 60.47 cm / 23.8 inches 1920 x 1080 60 Hz	Active matrix; thin film transistor (TFT) liquid crystal display (LCD); 0.275 mm dot pitch; 250 cd/m <sup>2</sup> white luminance; 3000:1 contrast ratio (typical), (30000:1 Contrast ratio, DV MODE ON).
Input Signal			
DisplayPort:	DisplayPort Connector:	Digital RGB	Up to 1920 x 1080 60 Hz, 8 bit, DisplayPort V1.2 (HDCP 1.3)
	USB-C Port:	Digital RGB	Up to 1920 x 1080 60 Hz, 8 bit, DisplayPort V1.2 (HDCP 1.3)
HDMI:	HDMI Connector:	Digital RGB / YUV	Up to 1920 x 1080 60 Hz, HDMI (HDCP 1.4)
Display Colors		16777216	Depends on display card used.
Synchronization Range	Horizontal: Vertical:	31.5 kHz to 81.1 kHz 50 Hz to 75 Hz	Automatically Automatically
Viewing Angle	Left/Right: Up/Down:	±89° (CR > 10) ±89° (CR > 10)	
Response Time		6 ms (Gray to Gray Typ.)	
Active Display Area	Landscape: Horiz.: Vert.: Portrait: Horiz.: Vert.:	527.0 mm / 20.7 inches 296.5 mm / 11.7 inches 296.5 mm / 11.7 inches 527.0 mm / 20.7 inches	
USB Hub	I/F: Port: Load Current:	SuperSpeed USB 5Gbps Upstream 1 (USB-C Port) Downstream 2 Downstream Port: DC 5 V/0.9 A (Max.) USB-C Port: 60 W (DC 20 V/3 A) (Max.)	
LAN		RJ-45 10 BASE-T/100 BASE-TX/1000 BASE-T	
AUDIO			
AUDIO Input:	DisplayPort Connector: USB-C Port (DisplayPort Alt. Mode): HDMI Connector:	Digital Audio Digital Audio Digital Audio	PCM 2ch 32, 44.1, 48 kHz (16/20/24bit) PCM 2ch 32, 44.1, 48 kHz (16/20/24bit) PCM 2ch 32, 44.1, 48 kHz (16/20/24bit)
Headphone Output: STEREO Mini Jack:		Headphone Impedance 32 Ohm	
Speakers	Practical Audio Output:	1.0 W+ 1.0 W	
Power Supply		AC 100-240 V, 50/60 Hz	
Current Rating		1.6 - 0.7 A	
Dimensions	Landscape: Portrait:	540.5 mm (W) x 381.0 – 501.0 mm (H) x 233.2 mm (D) 21.3 inches (W) x 15.0 – 19.7 inches (H) x 9.2 inches (D) 320.5 mm (W) x 554.2 – 611.0 mm (H) x 233.2 mm (D) 12.6 inches (W) x 21.8 – 24.1 inches (H) x 9.2 inches (D)	
Stand adjustable range	Height Adjustment: Tilt / Pivot / Swivel:	120 mm / 4.7 inches (Landscape orientation) 56.8 mm / 2.2 inches (Portrait orientation) Up 25° Down 5° / ± 90° / ± 170°	
Weight		Approx. 5.9 kg (13.0 lbs) (with monitor stand)/ Approx. 3.8 kg (8.4 lbs) (without monitor stand)	
Environmental Considerations			
Operating Temperature:		5°C to 35°C / 41°F to 95°F	
Humidity:		20% to 80%	
Altitude:		16,404 Feet or less / 5,000 m or less	
Storage Temperature:		-10°C to 60°C / 14°F to 140°F	
Humidity:		10% to 85%	
Altitude:		40,000 Feet or less / 12,192 m or less	

**NOTE:** Technical specifications are subject to change without notice.

# E274FL

Monitor Specifications		MultiSync E274FL	Notes
LCD Module	Diagonal: Viewable Image Size: Native Resolution:	68.60 cm / 27.0 inches 68.60 cm / 27.0 inches 1920 x 1080 60 Hz	Active matrix; thin film transistor (TFT) liquid crystal display (LCD); 0.311 mm dot pitch; 250 cd/m <sup>2</sup> white luminance; 4000:1 contrast ratio (typical), (30000:1 Contrast ratio, DV MODE ON).
Input Signal			
VGA:	Mini D-Sub 15-pin:	Analog RGB Sync	0.7 Vp-p / 75 ohm Separate sync. TTL level Positive/Negative
DisplayPort:	DisplayPort Connector:	Digital RGB	Up to 1920 x 1080 60 Hz, 8 bit, DisplayPort V1.2 (HDCP 1.3)
	USB-C Port:	Digital RGB	Up to 1920 x 1080 60 Hz, 8 bit, DisplayPort V1.2 (HDCP 1.3)
HDMI:	HDMI Connector:	Digital RGB / YUV	Up to 1920 x 1080 60 Hz, HDMI (HDCP 1.4)
Display Colors		16777216	Depends on display card used.
Synchronization Range	Horizontal: Vertical:	31.5 kHz to 83.0 kHz 50 Hz to 75 Hz	Automatically Automatically
Viewing Angle	Left/Right: Up/Down:	±89° (CR > 10) ±89° (CR > 10)	
Response Time		6 ms (Gray to Gray Typ.)	
Active Display Area	Landscape: Horiz.: Vert.: Portrait: Horiz.: Vert.:	597.9 mm / 23.5 inches 336.3 mm / 13.2 inches 336.3 mm / 13.2 inches 597.9 mm / 23.5 inches	
USB Hub	I/F: Port: Load Current:	SuperSpeed USB 5Gbps Upstream 1 (USB-C Port) Downstream 2 Downstream Port: DC 5 V/0.9 A (Max.) USB-C Port: 60 W (DC 20 V/3 A) (Max.)	
LAN		RJ-45 10 BASE-T/100 BASE-TX/1000 BASE-T	
AUDIO			
AUDIO Input:	DisplayPort Connector: USB-C Port (DisplayPort Alt. Mode): HDMI Connector:	Digital Audio Digital Audio Digital Audio	PCM 2ch 32, 44.1, 48 kHz (16/20/24bit) PCM 2ch 32, 44.1, 48 kHz (16/20/24bit) PCM 2ch 32, 44.1, 48 kHz (16/20/24bit)
Headphone Output: STEREO Mini Jack:		Headphone Impedance 32 Ohm	
Speakers	Practical Audio Output:	1.0 W+ 1.0 W	
Power Supply		AC 100-240 V, 50/60 Hz	
Current Rating		1.6 - 0.7 A	
Dimensions	Landscape: Portrait:	614.0 mm (W) x 401.7 – 521.7 mm (H) x 233.2 mm (D) 24.2 inches (W) x 15.8 – 20.5 inches (H) x 9.2 inches (D) 361.8 mm (W) x 627.4 – 647.7 mm (H) x 233.2 mm (D) 14.2 inches (W) x 24.7 – 25.5 inches (H) x 9.2 inches (D)	
Stand adjustable range	Height Adjustment: Tilt / Pivot / Swivel:	120 mm / 4.7 inches (Landscape orientation) 20.3 mm / 0.8 inches (Portrait orientation) Up 25° Down 5° / ± 90° / ± 170°	
Weight		Approx. 6.6 kg (14.6 lbs) (with monitor stand)/ Approx. 4.5 kg (9.9 lbs) (without monitor stand)	
Environmental Considerations			
Operating Temperature:		5°C to 35°C / 41°F to 95°F	
Humidity:		20% to 80%	
Altitude:		16,404 Feet or less / 5,000 m or less	
Storage Temperature:		-10°C to 60°C / 14°F to 140°F	
Humidity:		10% to 85%	
Altitude:		40,000 Feet or less / 12,192 m or less	

**NOTE:** Technical specifications are subject to change without notice.

# Appendix A OSD Controls List

## This Chapter Includes

- ⇒ “Luminance” on page 37
- ⇒ “Image Setup” on page 37
- ⇒ “Color Setup” on page 37
- ⇒ “OSD Setup” on page 37
- ⇒ “System Setup” on page 38
- ⇒ “Extra” on page 38
- ⇒ “OSD Warning” on page 38

Default values can be provided on request.

## Luminance

Luminance Menu	
Brightness	Adjusts the overall image and background screen brightness.
Contrast	Adjusts the image brightness in relation to the background.
ECO MODE	Decreases the amount of power consumption by reducing the brightness level.
Off	Sets the brightness variable range from 0% to 100%.
1	Sets the brightness variable range from 0% to 70%.
2	Sets the brightness variable range from 0% to 30%.
DV MODE (Dynamic Visual Mode)	Adjusts the brightness by detecting the screen's black areas and optimizes it. <b>NOTE:</b> [Off] is used for TCO Certificate compliance. When [Low Blue Light] is selected in [Preset], [DV MODE] is disabled.
Response Improve	This function may reduce blurring that occurs in some moving images. Select [On].

## Image Setup

Image Setup Menu	
Expansion	Sets the Zoom method.
Full	The image is expanded to full screen regardless of the resolution.
4:3	The image is expanded without changing the aspect ratio.

## Color Setup

Color Setup Menu	
Preset	Pre-configured color settings suitable for various situations. <b>NOTE:</b> The individual [Red], [Green], and [Blue] values can only be adjusted for the [USER] preset.
sRGB	sRGB dramatically improves the color fidelity in the desktop environment by a single standard RGB color space. This item cannot be adjusted.
5000K, 9300K	Adjusts the color temperature of the entire screen. A low color temperature will result in a reddish screen. A high color temperature will make the screen bluish. This item cannot be adjusted. The options are: [5000K] or [9300K].
Low Blue Light	Reduces blue light emitted from the monitor. This item cannot be adjusted. <b>NOTE:</b> When [Low Blue Light] is selected in [Preset], [DV MODE] is disabled.
USER	Allows for individual adjustment of the [Red], [Green], and [Blue] colors depending upon which is selected. The color change immediately affects the on-screen colors, and the bars will show the direction of the increase or decrease.

## OSD Setup

OSD Setup Menu	
Language	Selects the language used by the OSD.
OSD Turn Off	The OSD menu will stay open as long as it is in use. You can select how long the monitor waits after the last touch to close the OSD menu. The preset choices are 5 - 120 seconds by 5-second increments.

# System Setup

System Setup Menu	
USB	Selects a transfer speed of USB-C. USB2.0: The maximum transfer speed is equivalent to USB 2.0 (up to 480 Mbps). USB3.0: The maximum transfer speed is equivalent to USB 3.0 (up to 5 Gbps). <b>NOTE:</b> To avoid data loss, before changing the setting, ensure that no USB storage devices are in use by the operating system.
USB Functionality	Selects how power through the USB Type-A port and USB Type-C port, input signal from USB-C, and external communication of USB are enabled in relation to the monitor's power status. <b>NOTE:</b> <ul style="list-style-type: none"> <li>Actual power consumption depends on the connected USB device even when the monitor's power is off.</li> <li>To avoid data loss, before changing the setting, ensure that no USB storage devices are in use by the operating system.</li> <li>When turning on the monitor or after FACTORY PRESET or [USB Functionality] is set to [Off], USB Functionality message is shown when a USB-C cable is connected to the monitor. Please select a setting.</li> </ul>
Auto	Depending on the monitor's power condition.
On	Always working even when the monitor is in power save mode or power off.
Off	All USB functions (include USB Type-C video signal) are disabled.
USB LAN	Turns the LAN port [On] or [Off]. When using the LAN port, set this [On]. Please refer to " <a href="#">LAN connection</a> " (see <a href="#">page 22</a> ).
FACTORY PRESET	Resets all OSD control settings back to the default settings except [Language].

## Extra

Extra Menu	
Input Select	Selects the input signal source. Auto, HDMI, DisplayPort, USB-C.
Audio Mute	Mutes the speaker or headphone output.
Audio Volume	Controls the volume of the speakers or headphones.
DDC/CI	Turns the [DDC/CI] function [On] or [Off].

## OSD Warning

**No Signal:** This function gives a warning when there is no horizontal or vertical sync. After power is turned on or when there is a change of input signal, the "**No Signal**" window will appear. The message will close automatically.

**Out Of Range:** This function gives a recommendation of the optimized resolution and refresh rate. After the power is turned on, or there is a change of input signal, or if the video signal doesn't have proper timing, the "**Out Of Range**" message will appear. To close the message, please disconnect signal cables.

**This operation might increase power consumption. Do you want to continue?:** This function notifies of the increase in power consumption. The message appears when adjusting [DV MODE], [Brightness], or [ECO MODE] settings. To change the setting, select [Yes] in the message window and press the **Right** key. To return without changing, select [No] in the message window and press the **Left** key.

**USB Functionality:** This message gives a request to set [USB Functionality] setting. See "[USB Functionality](#)" above.



# Appendix B Manufacturer's Recycling and Energy Information

## This Chapter Includes:

- ⇒ "Disposing of your old NEC product" on page 40
- ⇒ "Energy Saving" on page 40
- ⇒ "WEEE Mark (European Directive 2012/19/EU and amendments)" on page 40

We are strongly committed to environmental protection and sees recycling as one of the company's top priorities in trying to minimize the burden placed on the environment. We are engaged in developing environmentally-friendly products, and always strive to help define and comply with the latest independent standards from agencies such as ISO (International Organisation for Standardization) and TCO (Swedish Trades Union).

## Disposing of your old NEC product

---

The aim of recycling is to gain an environmental benefit by means of re-use, upgrading, reconditioning or reclamation of material. Dedicated recycling sites ensure that environmentally harmful components are properly handled and securely disposed. To ensure the best recycling of our products, we offer a variety of recycling procedures and gives advice on how to handle the product in an environmentally sensitive way, once it has reached the end of its life.

All required information concerning the disposal of the product and country-specific information on recycling facilities can be found on our following websites:

<https://www.sharpnecdisplays.eu/p/hq/en/home.xhtml> (in Europe),

<https://www.sharp-nec-displays.com/jp/> (in Japan) or

<https://www.sharpnecdisplays.us/> (in USA).

## Energy Saving

---

This monitor features an advanced energy saving capability. When a Display Power Management signal is sent to the monitor, the Energy Saving mode is activated. The monitor enters a single Energy Saving mode.

For additional information visit:

<https://www.sharpnecdisplays.us/> (in USA)

<https://www.sharpnecdisplays.eu/p/hq/en/home.xhtml> (in Europe)

<https://www.sharp-nec-displays.com/global/index.html> (Global)

## WEEE Mark (European Directive 2012/19/EU and amendments)

---



### Disposing of your used product: In the European Union

EU-wide legislation as implemented in each Member State requires that used electrical and electronic products carrying the mark (left) must be disposed of separately from normal household waste. This includes monitors and electrical accessories, such as signal cables or power cords. When you dispose of such products, please follow the guidance of your local authority or ask the shop where you purchased the product, or if applicable, follow applicable legislation or agreement you may have. The mark on electrical and electronic products may only apply to the current European Union Member States.

### Outside the European Union

If you wish to dispose of used electrical and electronic products outside the European Union, please contact your local authority and ask for the correct method of disposal.

