

Installation Manual

Option Board

MultiSync ME-series



Important Information

Safety Precautions and Maintenance







FOR OPTIMUM PERFORMANCE, PLEASE NOTE
THE FOLLOWING WHEN SETTING UP AND
USING THE LCD COLOR MONITOR:







About the Symbols

To ensure safe and proper use of the product, this manual uses a number of symbols to prevent injury to you and others as well as damage to property. The symbols and their meanings are described below. Be sure to understand them thoroughly before reading this manual.







 WARNING	Failing to heed this symbol and handling the product incorrectly could result in accidents leading to major injury or death.
 CAUTION	Failing to heed this symbol and handling the product incorrectly could result in personal injury or damage to surrounding property.

Examples of symbols

	 Indicates a warning or caution. This symbol indicates you should be careful of electric shocks.
	 Indicates a prohibited action. This symbol indicates something that must be prohibited.
	 Indicates a mandatory action. This symbol indicates that the power cord should be unplugged from the power outlet.

 WARNING	
1	 UNPLUG THE POWER CORD Unplug the power cord if the product malfunctions. Should the product emit smoke or strange odors or sounds, or if the product has been dropped or the cabinet broken, turn off the product's power, then unplug the power cord from the power outlet. Failure to do so could not only lead to fire or electric shock, it could also result in vision impairment. Contact your dealer for repairs. Never try to repair the product on your own. Doing so is dangerous.
2	   Do not open or remove the product's cabinet. Do not disassemble the product. There are high voltage areas in the product. Opening or removing product covers and modifying the product may expose you to electric shock, fire, or other risks. Refer all servicing to qualified service personnel.
3	 Do not use the product if it has structural damage. If you notice any structural damage such as cracks or unnatural wobbling, please refer servicing to qualified service personnel. If the product is used in this condition, the product may fall or cause personal injury.

 **WARNING**

4		<p>Handle the power cord with care. Damaging the cord could lead to fire or electric shock.</p> <ul style="list-style-type: none"> • Do not place heavy objects on the cord. • Do not place the cord under the product. • Do not cover the cord with a rug, etc. • Do not scratch or modify the cord. • Do not bend, twist or pull the cord with excessive force. • Do not apply heat to the cord. <p>Should the cord be damaged (exposed core wires, broken wires, etc.), ask your dealer to replace it.</p>
5		<p>Do not touch the power plug if you hear thunder. Doing so could result in electric shock.</p>
6		<p>Please use the power cord provided with this product in accordance with the power cord table.</p> <p>If a power cord is not supplied with this product, please contact NEC. For all other cases, please use the power cord with the plug style that matches the power socket where the product is located. The compatible power cord corresponds to the AC voltage of the power outlet and has been approved by, and complies with, the safety standards in the country of purchase.</p>
7		<p>For proper installation it is strongly recommended to use a trained service person.</p> <p>Failure to follow the standard installation procedures could result in damage to the product or injury to the user or installer.</p>
8	 	<p>Please install the product in accordance with the following information.</p> <p>This product cannot be used or installed without the table top stand or other mounting accessory for support.</p> <ul style="list-style-type: none"> • ME651: DO NOT use this product on the floor with the table top stand. Please use this product on a table or with a mounting accessory for support. <p>When transporting, moving, or installing the product, please use as many people as necessary to be able to lift the product without causing personal injury or damage to the product.</p> <p>We recommend two or more people for the ME431/ME501/ME551 and four or more people for the ME651.</p> <p>Please refer to the instructions included with the optional mounting equipment for detailed information about attaching or removing.</p> <p>Do not cover the vent on the product. Improper installation of the product may result in damage to the product, an electric shock or fire.</p> <p>Do not install the product in the locations below:</p> <ul style="list-style-type: none"> • Poorly ventilated spaces. • Near a radiator, other heat sources, or in direct sunshine. • Continual vibration areas. • Humid, dusty, steamy, or oily areas. • Outdoors. • High-temperature environment where humidity changes rapidly and condensation is likely to occur. • A ceiling or wall that is not strong enough to support the product and mounting accessories. <p>Do not mount the product upside down.</p>

 **WARNING**



Prevent tipping and falling for earthquakes or other shocks.

To prevent personal injury or damage to the product caused by tipping over due to earthquakes or other shocks, make sure to install the product in a stable location and take measures to prevent falling.

The measures to prevent falling and tipping are intended for reducing the risk of injury, but may not guarantee the effectiveness against all earthquakes.

The product may tip causing personal injury.

- When using the product with the optional table top stand, fasten the product to a wall using a cord or chain that can support the weight of the product in order to prevent the product from falling. Fasten the cord or chain to the product using the clamps and screws provided with the product or the table top stand.
Depending on the table top stand, the stand has the structure for preventing tipping.
Please refer to the table top stand manual.
- Be sure to remove the cord or chain from the wall before moving the product to prevent personal injury or damage to the product.

The product may fall causing personal injury.

- Do not attempt to hang the product using an installation safety wire.
- Please install the product in an area on the wall or ceiling strong enough to support the weight of the product.
- Prepare the product using mounting accessories, such as hook, eyebolt, or mounting parts, and then secure the product with a safety wire. The safety wire must not be tight.
- Please make sure the mounting accessories are strong enough to support the product weight and size before installing it.







Stability Hazard.

The product may fall, causing serious personal injury or death. To prevent injury, this product must be securely attached to the floor/wall in accordance with the installation instructions.









Many injuries, particularly to children, can be avoided by taking simple precautions such as:

- ALWAYS use stands or installation methods recommended by the manufacturer of the product set.
- ALWAYS use furniture that can safely support the product.
- ALWAYS ensure the product is not overhanging the edge of the supporting furniture.
- ALWAYS educate children about the dangers of climbing on furniture to reach the product or its controls.
- ALWAYS route cords and cables connected to your product so they cannot be tripped over, pulled or grabbed.
- NEVER place a product in an unstable location.
- NEVER place the product on tall furniture (for example, cupboards or bookcases) without anchoring both the furniture and the product to a suitable support.
- NEVER place the product on cloth or other materials that may be located between the product and supporting furniture.
- NEVER place items that might tempt children to climb, such as toys and remote controls, on the top of the product or furniture on which the product is placed.
- If the existing product is going to be retained and relocated, the same considerations as above should be applied.





 **WARNING**

10		Do not place this product on a sloping or unstable cart, stand or table. Doing so could lead to falling or tipping and cause personal injury.
11	 	Do not insert objects of any kind into the cabinet slots. It may cause electric shock, fire, or product failure. Keep objects away from children and babies.
12		Do not spill any liquids into the cabinet or use your product near water. Immediately turn off the power and unplug your product from the wall outlet, then refer servicing to qualified service personnel. It may cause an electric shock or start a fire.
13		Do not use flammable gas sprays to remove dust when cleaning the product. Doing so could lead to a fire.
14		Securely fasten the Option Board. Ensure the Option Board is securely fastened using the original screws to prevent the Option Board from falling out the product. A falling Option Board may expose you to danger.

 **CAUTION**

1	  	<p>Handling the power cord.</p> <p>Handle the power cord with care. Damaging the cord could lead to fire or electric shock.</p> <ul style="list-style-type: none"> • When connecting the power cord to the product's AC IN terminal, make sure the connector is fully and firmly inserted. • Fasten the power cord to the product by attaching the screw and clamp to prevent loose connection. (Recommended Fasten Force: 120 - 190 N•cm). • Do not connect or disconnect the power cord with wet hands. • When connecting or disconnecting the power cord, pull the power cord out by holding onto its plug. • When cleaning the product, for safety purposes, unplug the power cord from the power outlet beforehand. Regularly dust off the power cord by using a soft dry cloth. • Before moving the product, make sure the product power is off, then unplug the power cord from the power outlet and check that all cables connecting the product to other devices are disconnected. • When you are not planning to use the product for an extended period of time, always unplug the power cord from the power outlet. • This equipment is designed to be used in the condition of the power cord connected to the earth. If the power cord is not connected to the earth, it may cause electric shock. Please make sure the power cord is earthed properly.
2		Do not bind the power cord and the USB cable. It may trap heat and cause a fire.
3		Do not connect to a LAN with excessive voltage. When using a LAN cable, do not connect to a peripheral device with wiring that might have excessive voltage. Excessive voltage on the LAN port may cause an electric shock.
4		Do not climb on the table where the product is installed. Do not install the product on a wheeled table if the wheels on the table have not been properly locked. The product may fall, causing damage to the product or personal injury.
5		Installation, removal, and height adjustment of the optional table top stand. <ul style="list-style-type: none"> • When installing the table top stand, handle the unit with care to avoid pinching your fingers. • Installing the product at the wrong height can cause tipping. Please install your product at proper height to prevent personal injury or damage to the product.
6		Do not push or climb on the product. Do not grab or hang onto the product. The product may fall, causing damage to the product or personal injury.
7		Do not impact the LCD panel surface, it can cause serious damage to the product or personal injury.

 **CAUTION**

8		<p>Incorrect usage of batteries can result in leaks or bursting.</p> <ul style="list-style-type: none"> • Insert batteries matching the (+) and (–) signs on each battery to the (+) and (–) signs of the battery compartment. • Do not mix battery brands. • Do not combine new and old batteries. This can shorten battery life or cause liquid leakage of batteries. • Remove dead batteries immediately to prevent battery acid from leaking into the battery compartment. • Do not touch exposed battery acid, it may injure your skin. • Disposal of a battery into fire or a hot oven, or mechanically crushing or cutting of a battery, that can result in an explosion. • Leaving a battery in an extremely high temperature surrounding environment, or a battery subject to extremely low air pressure, that can result in an explosion or the leakage of flammable liquid or gas. • Contact your dealer or local authorities when disposing of batteries.
9		Suitable for entertainment purposes at controlled luminous environments, to avoid disturbing reflections from the screen.
10		When running the cooling fan continuously, we recommend wiping clean the ventilation holes a minimum of once a month. Failure to do so could lead to fire or electric shock or damage to the product.
11		To ensure the product's reliability, please clean the ventilation holes at the rear side of the cabinet at least once a year to remove dirt and dust. Failure to do so could lead to fire or electric shock or damage to the product.

Power Cord Table

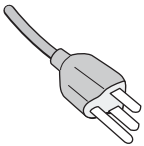
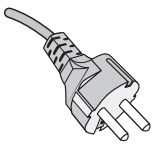
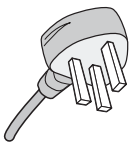
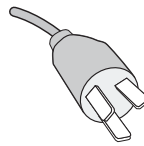
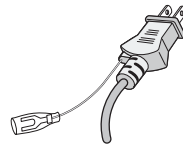
Plug Type	North America	European Continental	U.K.	Chinese	Japanese
Plug Shape					
Region	U.S.A./Canada	EU	U.K.	China	Japan
Voltage	120*	230	230	220	100

* Please use this power cord under 125 V power supply.

NOTE: This product can only be serviced in the country where it was purchased.

MultiSync is a trademark or registered trademark of NEC Display Solutions, Ltd. in Japan and other countries.

Intel and the Intel logo are trademarks of Intel Corporation or its subsidiaries.

All other brands and product names are trademarks or registered trademarks of their respective owners.

Installing an Option Board

You can install Option Boards that are compatible with Intel® Smart Display Module Small (Intel® SDM-S) and Intel® Smart Display Module Large (Intel® SDM-L) specifications.

1. Turn off the main power switch.
2. Place the monitor face down on a flat even surface that is larger than the monitor screen. Use a sturdy table that can easily support the weight of the monitor.

NOTE: To avoid scratching the LCD panel, always place a soft cloth, such as a blanket that is larger than the monitor's screen area, on the table before laying the monitor face down. Make sure there is nothing on the table that can damage the monitor.

3. Remove the SLOT COVER ① and ②, and then the OPTION COVER ① (Figure 1).

When using Intel® SDM-L type option board, slide the CENTER RAIL to the right and remove it. Reverse the process to re-attach it (Figure 1-1).

4. Attach the included OPTION COVER ② with the removed screws (Figure 2).

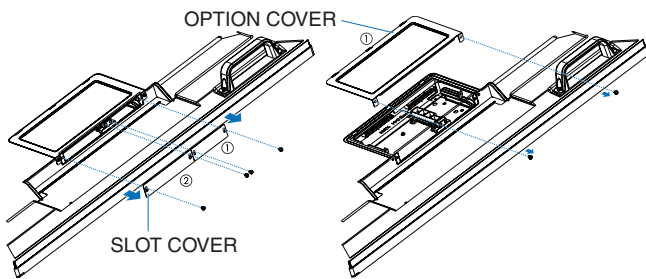
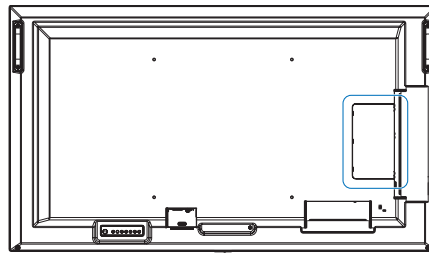

Figure 1

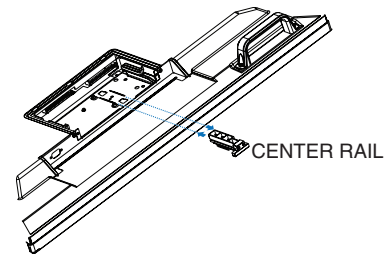

Figure 1-1

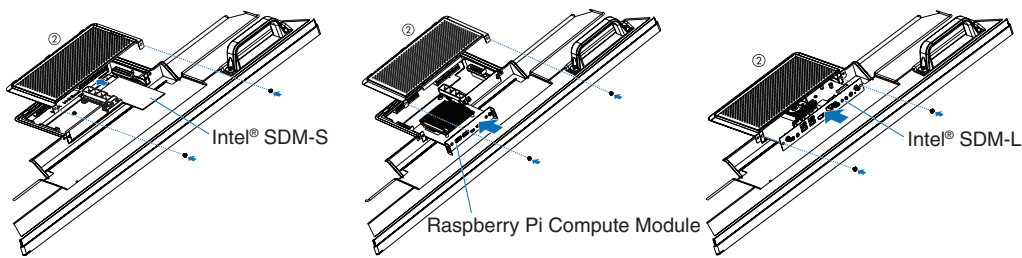

Figure 2

5. Insert the Option Board into the monitor and affix it in place with the removed screws (Figure 2). (Recommended fasten force: 50 - 80 N•cm).

6. To close the opening of the slot you did not use, reattach the SLOT COVER (① or ②) with the removed screws (See **Figure 1**). When attaching the SLOT COVER ① or ②, use the holes (A) shown below in the SLOT COVER (**Figure 3**).

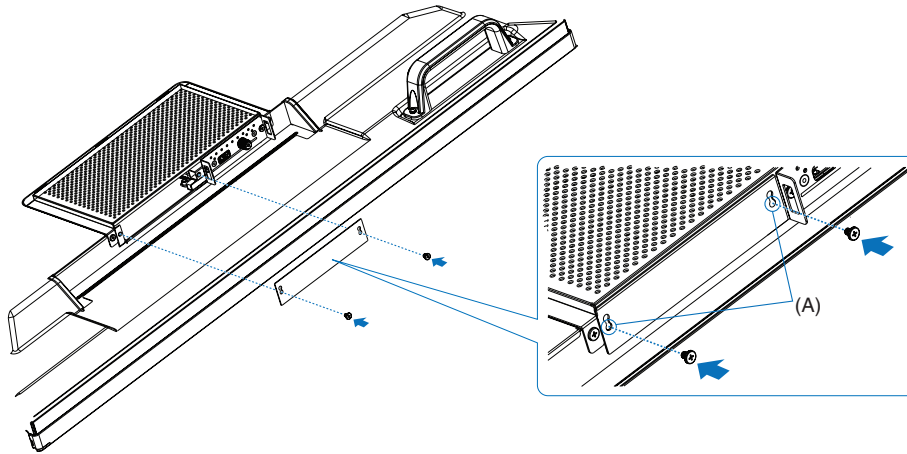

Figure 3

NOTE: Unless your monitor is purchased as part of a special bundle package, no Option Boards will be in the box or installed in the monitor. These are optional accessories available for separate purchase. Please contact your supplier for a list of Option Boards available for your monitor.

Make sure the board is inserted into the slot in the correct orientation.

Do not apply excessive force to manipulate the Option Board before attaching it with screws.

⚠ WARNING: Please refer to [“WARNING 14”](#).