

Large Format Display
User's Manual

NEC

E656

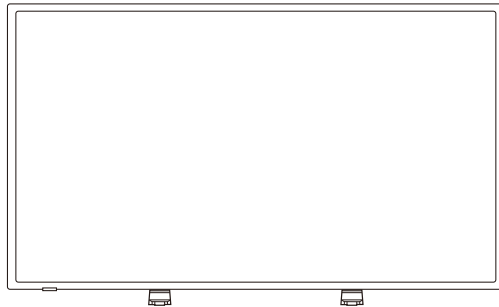

E556

E506

E436

E326

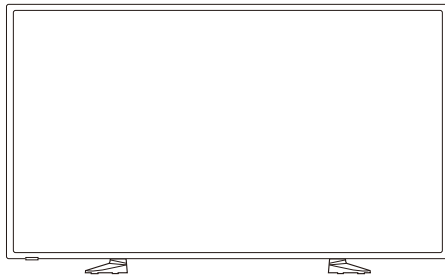







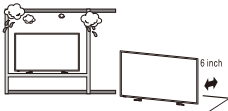
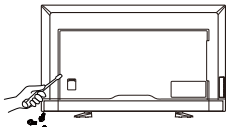

Please find your model name in the label on the backside of display.

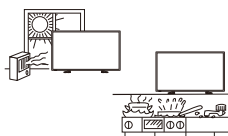
Index

Precautions And Reminders	English-1
Important Safety Instructions	English-2
Important Information	English-4
License Notice and Trademark Acknowledgement	English-8
Declaration Of Conformity	English-9
Contents	English-10
Preparation	English-11
Attaching the Base	English-11
Using Cable Clamper	English-12
Preparing Your Display For Wall Mounting (optional).....	English-12
Prohibit portrait condition use.....	English-13
Place The Display On A Solid Surface	English-14
Battery Installation and Replacement.....	English-14
Connect To The Power Source	English-15
Power On/Off Your New Display	English-15
Power Mode Status	English-15
Source Connection Guide	English-18
Operating Instructions	English-20
Using The Side Panel Controls	English-20
Using The Remote Control.....	English-21
Operating Range for the Remote Control.....	English-22
Timing Table	English-23
Navigating The On-Screen Menu	English-24
Video Menu	English-24
Audio Menu	English-25
Setup Menu	English-25
USB Menu	English-27
USB Demo Mode	English-30
Maintenance and Recycling	English-31
Care Of The Screen	English-31
Mobile Telephone Warning	English-31
End Of Life Directives.....	English-31
Italian Homologation declaration	English-31
Manufacturer's Recycling and Energy Information.....	English-32
Disposing of your old NEC product	English-32
Energy Saving	English-32
WEEE Mark (European Directive 2012/19/EU).....	English-33
Specification	English-34
Product Specifications.....	English-34
RS-232C Port Specifications.....	English-39
Supporting HDMI CEC command	English-40
Before Calling Service	English-41
Glossary	English-42

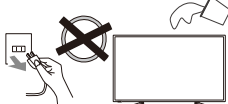
Precautions And Reminders

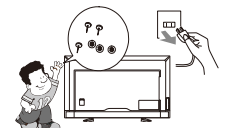
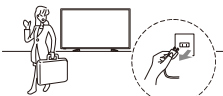
<p>Do not place the display in confined spaces or in a box when in use. Maintain ample ventilation for the display when in use.</p> 	<p>Do not open the display cabinet.</p> 	<p>Call a NEC certified service personnel for any internal service needed for your display.</p> 
<p>Keep the display away from direct sunlight, dust, humidity, smoke and oily areas.</p> 	<p>Unplug immediately if the display falls.</p> 	<p>Unplug immediately if there is a display malfunction such as a loss of audio/video, the presence of smoke, or a bad odor coming from the display.</p> 
<p>Unplug the AC cord from the AC outlet before cleaning. Do not use liquid cleaners or aerosol cleaners to clean the display.</p> 	<p>Do not place the display near water such as a bathtub, washbasin, sink, laundry tub, swimming pool, or a damp basement. Unplug immediately if the display has been exposed to rain or water.</p> 	<p>Do not cover or block any vents or openings. Inadequate ventilation may shorten the life of the display and cause overheating.</p> 
<p>Place the unit on a sturdy, even surface.</p> 	<p>Do not insert any foreign objects into the display cabinet. Unplug immediately if objects have fallen into the display.</p> 	<p>Unplug the power cord from the outlet when the display is not in use for long periods of time (days).</p> 

Notice for Remote Controller

<p>Avoid Liquids</p> 	<p>Avoid Aerosol Cleaners</p> 	<p>Avoid Dropping</p> 
--	---	---

Important Safety Instructions

Read before operating equipment

Follow all warnings and instructions marked on this display.

1. Read these instructions.
2. Keep these instructions.
3. Heed all warnings.
4. Follow all instructions.
5. Do not use this apparatus near water.
6. Clean only with dry cloth.
7. Do not block any ventilation openings. Install in accordance with the manufacturer's instructions.
8. Do not install near any heat sources such as radiators, heat registers, stoves, or other apparatus (including amplifiers) that produce heat.
9. Do not defeat the safety purpose of the polarized or grounding-type plug. A polarized plug has two blades with one wider than the other. A grounding type plug has two blades and a third grounding prong. The wide blade or the third prong are provided for your safety. If the provided plug does not fit into your outlet, consult an electrician for replacement of the obsolete outlet.
10. Protect the power cord from being walked on or pinched particularly at plugs, convenience receptacles, and the point where they exit from the apparatus.
11. Only use attachments/accessories specified by the manufacturer.
12. Use only with the cart, stand, tripod, bracket, or table specified by the manufacturer, or sold with the apparatus. When a cart is used, use caution when moving the cart/apparatus combination to avoid injury from tip-over.



13. Unplug this apparatus during lightning storms or when unused for long periods of time.
14. Refer all servicing to qualified service personnel. Servicing is required when the apparatus has been damaged in any way, such as power-supply cord or plug is damaged, liquid has been spilled or objects have fallen into the apparatus, the apparatus has been exposed to rain or moisture, does not operate normally, or has been dropped. Unplug immediately if the display faces above condition.

15. The display complies with the recommended safety standards for stability. Do not put excessive force on the front or top of the cabinet. This could cause the product to tip over and cause damage and/or personal injury.
16. If display or glass is broken, do not come in contact with the liquid crystal and handle with care.
17. Follow instructions for wall, shelf or ceiling mounting as recommended by the manufacturer.
18. Rest your eyes periodically by focusing on an object at least 5 feet away. Blink often.
19. Do not place any heavy objects on the power cord. Damage to the cord may cause shock or fire.
20. Do not use display in high temperature, humid, dusty, or oily areas.
21. Do not bend, crimp or otherwise damage the power cord.
22. Apparatus shall not be exposed to dripping or splashing and no objects filled with liquids, such as vases, shall be placed on the apparatus



WARNING: To prevent the spread of fire, keep candles or other open flames away from this product at all times.

IMPORTANT INFORMATION

If a display is not positioned in a sufficiently stable location, it can be potentially hazardous due to falling. Many injuries, particularly to children, can be avoided by taking simple precautions such as:

- Using cabinets or stands recommended by the manufacturer of the display.
- Only using furniture that can safely support the display.
- Ensuring the display is not overhanging the edge of the supporting furniture.
- Not placing the display on tall furniture (for example, cupboards or bookcases) without anchoring both the furniture and the display to a suitable support.
- Not standing the displays on cloth or other materials placed between the display and supporting furniture.
- Educating children about the dangers of climbing on furniture to reach the display or its controls.

WARNING: To prevent injury, this apparatus must be securely attached to the floor/wall in accordance with the installation instructions.

Important Information



WARNING



TO PREVENT FIRE OR SHOCK HAZARDS, DO NOT EXPOSE THIS UNIT TO RAIN OR MOISTURE. ALSO, DO NOT USE THIS UNIT'S POLARIZED PLUG WITH AN EXTENSION CORD RECEPTACLE OR OTHER OUTLETS UNLESS THE PRONGS CAN BE FULLY INSERTED.

REFRAIN FROM OPENING THE CABINET AS THERE ARE HIGH VOLTAGE COMPONENTS INSIDE.

REFER SERVICING TO QUALIFIED SERVICE PERSONNEL.



CAUTION







CAUTION: TO REDUCE THE RISK OF ELECTRIC SHOCK, MAKE SURE POWER CORD IS UNPLUGGED FROM WALL SOCKET. TO FULLY DISENGAGE THE POWER TO THE UNIT, PLEASE DISCONNECT THE POWER CORD FROM THE AC OUTLET. DO NOT REMOVE COVER (OR BACK). NO USER SERVICEABLE PARTS INSIDE. REFER SERVICING TO QUALIFIED SERVICE PERSONNEL.

 This symbol warns user that uninsulated voltage within the unit may have sufficient magnitude to cause electric shock. Therefore, it is dangerous to make any kind of contact with any part inside this unit.

 This symbol alerts the user that important literature concerning the operation and maintenance of this unit has been included. Therefore, it should be read carefully in order to avoid any problems.

CAUTION:

Please use the power cord provided with this display in accordance with the table below. If a power cord is not supplied with this equipment, please contact your supplier. For all other cases, please use a power cord that matches the AC voltage of the power outlet and has been approved by and complies with the safety standard of your particular country.

Plug Type	European Continental	U.K.	Japanese	North America
Plug Shape				
Region	EU (except U.K.)	U.K.	Japan	U.S.A./Canada
Voltage	230	230	100	120

This display operates on 100-240 volts 50-60 Hz, AC current. Insert the power cord into a 100-240 volts 50-60 Hz outlet. The mains plug is used as the disconnect device and shall remain readily operable.

To prevent electric shock from the display, do not use with an extension cord, receptacle, or other outlet unless the blades and ground terminal can be fully inserted to prevent blade exposure.

Never connect the display to other than the specified voltage.

CAUTION:

Never remove the back cover of the display as this can expose you to very high voltages and other hazards. If the display does not operate properly, unplug the display and call your authorized dealer or service center.

Adjust only those controls that are covered in the instructions, as improper changes or modifications not expressly approved by NEC could void the user's warranty.

Batteries installed warning

Incorrect usage of batteries can result in leaks or bursting.

NEC recommends the following battery use:

- Do not mix battery brands.
- Danger of explosion if battery is incorrectly replaced. Replace only with the same or equivalent type.
- Do not combine new and old batteries. This can shorten the battery life or cause liquid leakage of the batteries.
- Remove dead batteries immediately to prevent battery acid from leaking into the battery compartment.
- Do not touch exposed battery acid as it may injure skin.
- Remove the batteries if you do not intend to use the remote control for a long period of time.
- The batteries shall not be exposed to excessive heat such as sunshine, fire or the like.

Image persistence

Please be aware that LCD Technology may experience a phenomenon known as Image Persistence. Image Persistence occurs when a residual or "ghost" image of a previous image remains visible on the screen. Unlike CRT monitors, LCD displays' image persistence is not permanent, but constant images being displayed for a long period of time should be avoided. To alleviate image persistence, turn off the display for as long as the previous image was displayed. For example, if an image was on the display for one hour and a residual image remains, the display should be turned off for one hour to erase the image.

NOTE:

As with all personal display devices, NEC DISPLAY SOLUTIONS recommends displaying moving images and using a moving screen saver at regular intervals whenever the screen is idle or turning off the display when not in use.

CAUTION:

These servicing instructions are for use by qualified service personnel only. To reduce the risk of electric shock, do not perform any servicing other than that contained in the operating instructions unless you are qualified to do so.

Ventilation

The slots and openings in the display are provided for necessary ventilation. To ensure reliable operation of the display and to protect it from overheating, these slots and openings must never be blocked or covered.

Unless proper ventilation is provided, the display may gather dust and get dirty. For proper ventilation, observe the following:

- Do not install the display face up, down or sideways.
- Do not install the display turned over or upside down.
- Never cover the slots and openings with a cloth or other materials.
- Never block the slots and openings by placing the display on a bed, sofa, rug or other similar surface.
- Never place the display in a confined space, such as a bookcase or built-in cabinet, unless proper ventilation is provided.

Leave some space around the display set as shown below. Otherwise, air-circulation may be inadequate and will cause overheating, which may cause a fire or damage to the display set.

Install on the wall

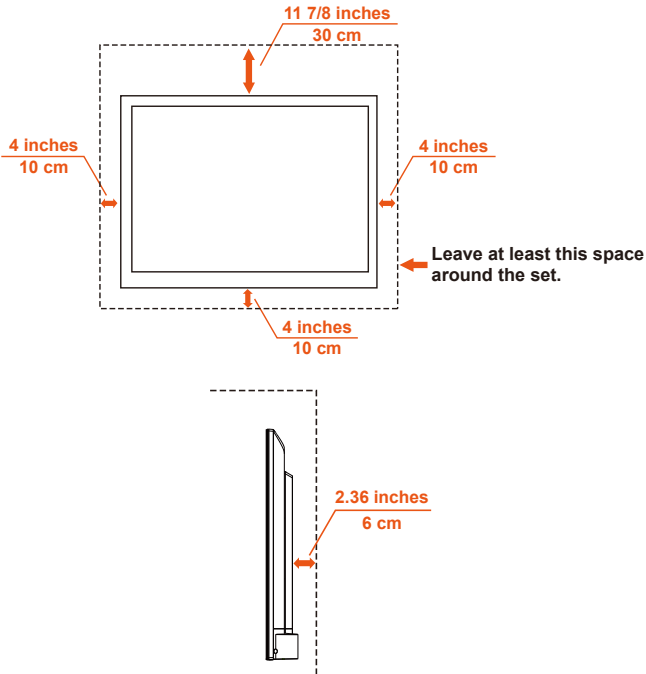

For use only with UL Listed Wall Mount Bracket with minimum weight/load:
Please refer to the Specification on page 34.

Unit without base weight: The equipment and its associated mounting means still remain secure during the test.

Used wall mounting kit, VESA-compatible wall bracket distance, diameter of Screw dimension: Please refer to the Specification on page 34.

Installed with stand

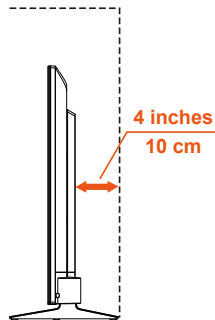
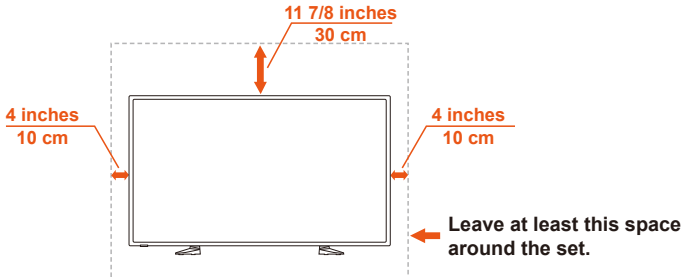

Never install the display set where air-circulation is blocked.

Objects and ventilation holes

Never push objects of any kind into the display through the cabinet slots as they may touch dangerous voltage points or short out parts that could result in a fire or an electric shock. Do not place any objects on the display.

License Notice and Trademark Acknowledgement

Windows is a registered trademark of Microsoft Corporation.
NEC is a registered trademark of NEC Corporation.
All other brands and product names are trademarks or registered trademarks of their respective owners.



HIGH-DEFINITION MULTIMEDIA INTERFACE

The terms HDMI and HDMI High-Definition Multimedia Interface, and the HDMI Logo are trademarks or registered trademarks of HDMI Licensing Administrator, Inc. in the United States and other countries.



Manufactured under license from Dolby Laboratories.
Dolby, Dolby Audio and the double-D symbol are trademarks of Dolby Laboratories.

HDCP (High-bandwidth Digital Content Protection): HDCP is a system for preventing illegal copying of video data sent over a digital signal. If you are unable to view material via the digital input, this does not necessarily mean the display is not functioning properly. With the implementation of HDCP, there may be cases in which certain content is protected with HDCP and might not be displayed due to the decision/intention of the HDCP community (Digital Content Protection, LLC).

[Notice] About the MPEG AVC license included in this product

MPEG AVC

THIS PRODUCT IS LICENSED UNDER THE AVC PATENT PORTFOLIO LICENSE.
SUCH LICENSE EXTENDS TO THIS PRODUCT ONLY AND ONLY TO THE EXTENT OF OTHER NOTICES WHICH MAY BE INCLUDED HEREIN. THE LICENSE DOES NOT EXTEND TO ANY OTHER PRODUCT REGARDLESS OF WHETHER SUCH PRODUCT IS INCLUDED WITH THIS LICENSED PRODUCT IN A SINGLE ARTICLE. ADDITIONAL INFORMATION MAY BE OBTAINED FROM MPEG LA, L.L.C. SEE [HTTP://WWW.MPEGLA.COM](http://www.mpegla.com)

Declaration Of Conformity

This device complies with Part 15 of FCC Rules. Operation is subject to the following two conditions. (1) This device may not cause harmful interference, and (2) this device must accept any interference received, including interference that may cause undesired operation.

U.S. Responsible Party:	NEC Display Solutions of America, Inc.	
Address:	500 Park Boulevard, Suite 1100 Itasca, Illinois 60143	
Tel. No.:	(630) 467-3000	

Type of Product:	Display	
Equipment Classification:	Class B Peripheral	
Model:	E656	E436
	E556	E326
	E506	



We hereby declare that the equipment specified above conforms to the technical standards as specified in the FCC Rules.

Canadian Department of Communications Compliance Statement

DOC: This Class B digital apparatus meets all requirements of the Canadian Interference-Causing Equipment Regulations.

C-UL: Bears the C-UL Mark and is in compliance with Canadian Safety Regulations according to CAN/CSA C22.2 No. 60065-03.

FCC information

- Use the attached specified cables with the E656 / E556 / E506 / E436 / E326 color display so as not to interfere with radio and television reception.
 - Please use the supplied power cord or equivalent to ensure FCC compliance.
 - Please use the supplied shielded video signal cable, Mini D-SUB 15pin to Mini D-SUB 15 pin.
- This equipment has been tested and found to comply with the limits for a Class B digital device, pursuant to part 15 of the FCC Rules. These limits are designed to provide reasonable protection against harmful interference in a residential installation. This equipment generates, uses and can radiate radio frequency energy and, if not installed and used in accordance with the instructions, may cause harmful interference to radio communications. However, there is no guarantee that interference will not occur in a particular installation. If this equipment does cause harmful interference to radio or television reception, which can be determined by turning the equipment off and on, the user is encouraged to try to correct the interference by one or more of the following measures:
 - Reorient or relocate the receiving antenna.
 - Increase the separation between the equipment and receiver.
 - Connect the equipment into an outlet on a circuit different from that to which the receiver is connected.
 - Consult the dealer or an experienced radio/TV technician for help.

Canadian notice

CAN ICES-3 (B) / NMB-3(B)

Contents

Your new NEC display box*¹ should contain the following:

- Display
- Power cord*²
- D-sub Cable
- Remote Control
- 1.5V AAA Size Batteries x2
- Setup Manual x1
- CD ROM

E656 / E556 / E506 / E436 / E326



(EU)
Power Cord*²

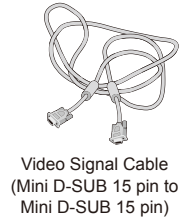

Video Signal Cable
(Mini D-SUB 15 pin to
Mini D-SUB 15 pin)



Wireless Remote Control
and AAA Batteries

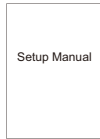

Setup Manual

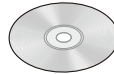

CD-ROM

NOTE:

*1: Remember to save your original box and packing material to transport or ship the display.

*2: Type and number of power cords included will depend on the where the display is to be shipped. When more than one power cord is included, please use a power cord that matches the AC voltage of the power outlet and has been approved by and complies with the safety standard of your particular country.

*3: The following stand base and screw are option parts.

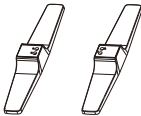

(E656)

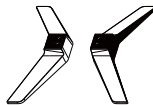

(E556/E506/E436/E326)
Stand Base



E656: M6 (30mm) x 4
E556/E506: M6 (22mm) x 4
E436/E326: M4 (20mm) x 4
Stand Screw

Preparation

IMPORTANT: Do not apply pressure to the screen display area which may compromise the integrity of the display. The manufacturer's warranty does not cover user abuse or improper installations.

Attaching the Base

E656

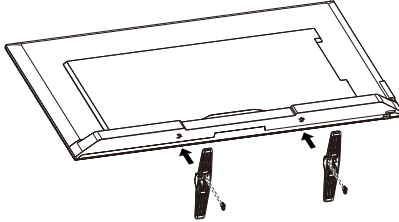

Stand Screw x 4
E656: M6 (30mm)

E556 / E506 / E436 / E326

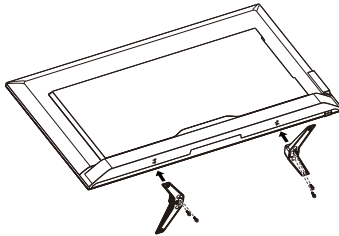

Stand Screw x 4
E556/E506: M6 (22mm)
E436/E326: M4 (20mm)

1. Place the display face down on a soft and flat surface to prevent scratching and damage.
2. Carefully align the base to the button of the display and fasten the screws with a cross-head screwdriver.

CAUTION:

The base of the stand is very heavy. Install with care to avoid injury such as dropping the base onto one's foot.

Using Cable Clamper

Tie the cables together using the cable clamper.

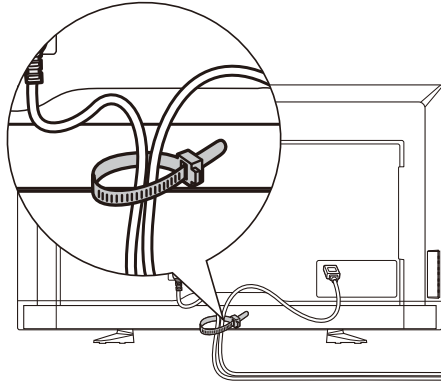

Preparing Your Display For Wall Mounting (optional)

We suggest that you keep your display at least 2.36 inches (60 mm) from the wall to prevent cable interference. Before mounting your display on the wall, you need to remove the base. For your safety, only mount with a UL listed wall mount bracket that supports the weight of the display. (Please see page 34.) To attach a wall mount bracket to your display:

E656

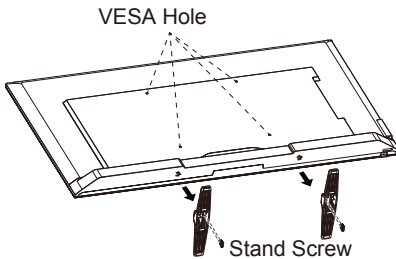

1. Loosen the screws on the bottom of the base, and remove the base.
2. Secure the wall mount bracket to the back of your display using four M6 screws.

screen size (inches)	required pitch (mm)	VESA hole depth
65	400 x 400	4 x M6 (16 mm)

E556 / E506 / E436 / E326

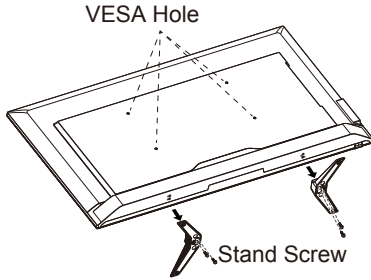

1. Loosen the screws on the button of the base, and remove the base.
2. Secure the wall mount bracket to the back of your display using four M4 screws (for 32" only) or M6 screws (for 43"/50"/55" only).

screen size (inches)	required pitch (mm)	VESA hole depth
55	400 x 200	4 x M6 (17.5 mm)
50	400 x 200	4 x M6 (15 mm)
43	200 x 200	4 x M6 (16 mm)
32	100 x 100	4 x M4 (12.5 mm)

NOTE:

Wall mounting solution is not included with the unit and is sold separately. Contact your NEC representative for details.

It is necessary to provide screw of appropriate length (Wall mount bracket thickness + VESA hole depth).

Prohibit portrait condition use

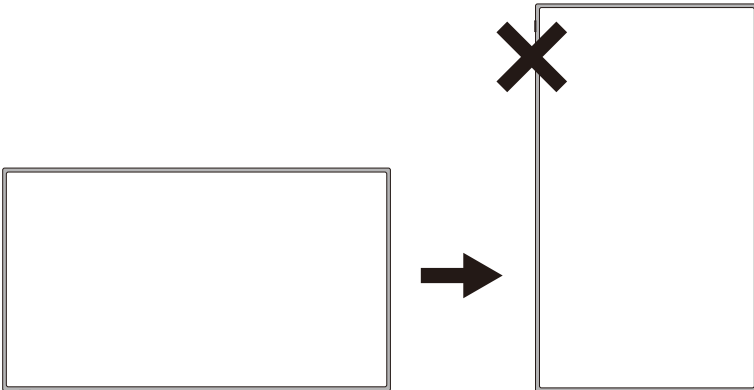

CAUTION:

Do not rotate the display from landscape to portrait.

Place The Display On A Solid Surface

Ensure that the display is placed in a position to allow free flow of air. Do not cover the ventilation openings on the back cover. Do not place the display near any open flames. Do not allow the display to be placed in an environment where it can be exposed to heat, direct sunlight, or rain and water. Do not expose the equipment to any liquid.

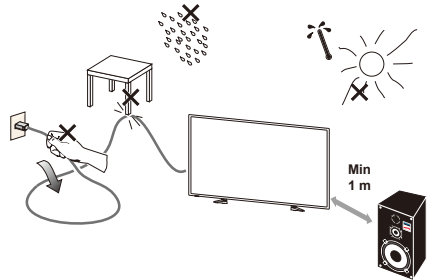

Battery Installation and Replacement

The remote control is powered by two 1.5V AAA batteries. To install or replace batteries:

1. Open the battery cover of the remote control by pushing and pulling it in the direction of the arrow.
2. Insert two new "AAA" size batteries for the remote control. When replacing old batteries, push them towards the springs and lift them out.
3. Match the batteries to the (+) and (-) marks in the battery compartment.
4. Insert the bottom of the battery, the (-) side, into the battery compartment first, push towards the springs and insert the top of the battery, the (+) side, into place. Do not force the battery into the battery compartment.
5. Close the battery cover making sure the tabs rest in the corresponding holes and push down the cover until it clicks shut.

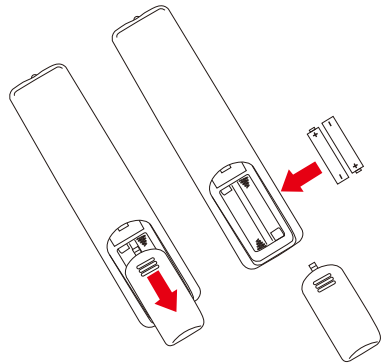

Connect To The Power Source

The display should be installed close to an easily accessible power outlet. Fully insert the prongs into the power outlet socket. A loose connection may cause image degradation.

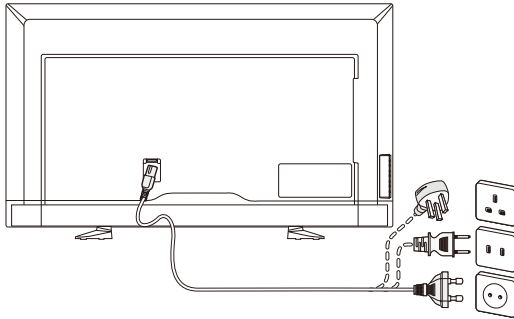

If there is power to the display, the front LED at the bottom of the display will be either none or red. A red LED means the display is in standby mode.

Power On/Off Your New Display

Press the power button on the remote control or press the power button located on the side of the display. The display will power on.

Power button



or

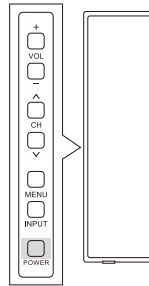

Power Mode Status

When in ON mode, the display operates as follows if no external signal is input.

Mode	ON	Auto Power save	Auto Standby
LED Status	None	Blinking Red	Red

- 1-1. HOME mode is set under Energy Options in the on-screen display menu.
- 1-2. When the external device is connected to the VGA terminal, the NO SIGNAL menu is displayed and 10 seconds later the display switches to Auto Power save mode.
- 1-3. In Auto Power save mode at VGA terminal, when the display receives a signal from an external VGA device, it switches automatically to ON mode.

NOTE:

Note that in Auto Power save mode at VGA terminal, the display does not switch automatically to ON mode even if a signal is input from an external device using HDMI, component video or composite video.

If the power cord is unplugged during Auto Power save mode at VGA terminal, the display will start in Auto Standby mode the next time it is turned on.

- 1-4. When the external device is connected to another terminal (HDMI, component video, composite video), the NO SIGNAL menu is displayed and 10 seconds later the display switches to Auto Power save mode.
- 1-5. For example, In Auto Power save mode at HDMI-1 terminal, when the display receives a signal from an external HDMI-1 device, it switches automatically to ON mode.
- 1-6. For example, In Auto Power save mode at HDMI-1 terminal, when the display does not receive a signal from external HDMI-1 device, after 30 minutes, it switches automatically to Auto Standby mode.
- 1-7. For example, In Auto Standby mode at HDMI-1 terminal, press the power button on the remote control or on the side panel to switch the display to ON mode.

NOTE:

For example, Note that in Auto Power save mode at HDMI-1 terminal, the display does not switch automatically to ON mode even if a signal is input from an external device using VGA, HDMI-2, HDMI-3, component video or composite video.

- 2-1. RETAIL mode is set under Energy Options function in the on-screen display menu.
- 2-2. When the external device is connected to the VGA, HDMI, component video, composite video terminal, the NO SIGNAL menu is displayed. The display keeps ON mode.
- 2-3. For example, In ON mode at HDMI-1 terminal, when the display receives a signal from an external HDMI-1 device, The display disappears NO SIGNAL menu and displays contents.
- 3-1. OFFICE mode is set under Energy Options in the on-screen display menu
- 3-2. When the external device is connected to the VGA terminal, the NO SIGNAL menu is displayed and 10 seconds later the display switches to Auto Power save mode.

- 3-3. In Auto Power save mode at VGA terminal, when the display receives a signal from an external VGA device, it switches automatically to ON mode.

NOTE:

Note that in Auto Power save mode at VGA terminal, the display does not switch automatically to ON mode even if a signal is input from an external device using HDMI, component video or composite video.

If the power cord is unplugged during Auto Power save mode at VGA terminal, the display will start in Auto Standby mode the next time it is turned on.

- 3-4. When the external device is connected to another terminal (HDMI, component video, composite video), the NO SIGNAL menu is displayed and 10 seconds later the display switches to Auto Power save mode.
- 3-5. For example, In Auto Power save mode at HDMI-1 terminal, when the display receives a signal from an external HDMI-1 device, it switches automatically to ON mode.
- 3-6. For example, In Auto Power save mode at HDMI-1 terminal, when the display does not receive a signal from external HDMI-1 device, the display keeps Auto Power save mode.

NOTE:

For example, Note that in Auto Power save mode at HDMI-1 terminal, the display does not switch automatically to ON mode even if a signal is input from an external device using VGA, HDMI-2, HDMI-3, component video or composite video.

NOTE:

When switching mode (Home/Retail/Office) under Energy Options function, the setting values in Video Menu return to default value.

Also, if Retail mode is set under Energy Options function, the setting values in Video Menu return to default value after turning On/Off by the AC power supply, switching On/Off by the power button on remote control or on the side of the display.

Source Connection Guide

E656

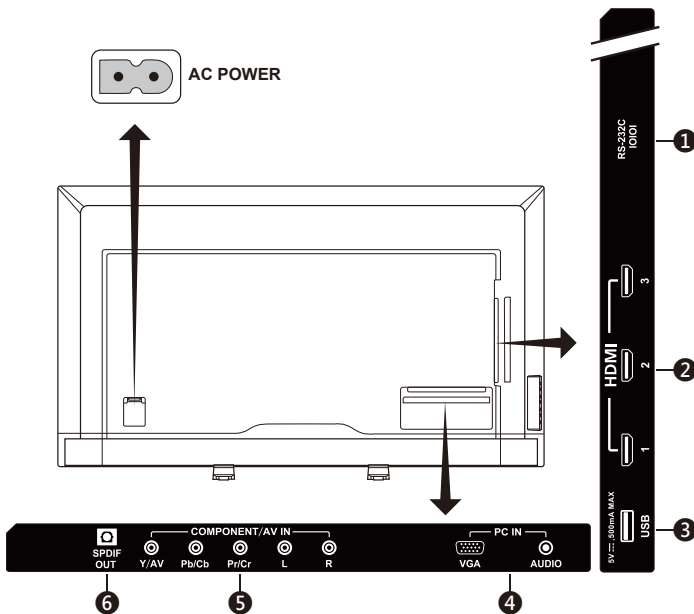

1. **RS-232C** – Connect to your PC, and receive the control commands from the PC.
2. **HDMI (HDMI-1, HDMI-2, HDMI-3)** – Connect to your HDMI devices. HDMI-1 terminal can support ARC (Audio Return Channel) function. ARC output does not work sound effect (Sound mode, Balance, Bass, Treble on OSD).
3. **USB port** – Used for accessing photo, music, and movie files.
4. **PC IN (VGA / AUDIO)** – Connect to your PC video and audio.
5. **COMPONENT / AV IN** –
 - Component: Connect to digital video equipment to the Video Green (Y), Blue (Pb), Red (Pr) jacks, and matching Audio White (L) and Red (R) jacks.
 - Composite: Connect to digital video equipment to the Video Green (AV), jacks, and matching Audio White (L) and Red (R) jacks.
6. **SPDIF OUT**- Use a digital audio cable to connect to stereo home theater system. SPDIF output does not work sound effect (Sound mode, Balance, Bass, Treble on OSD). SPDIF output does not work Auto function of Internal Speakers on OSD.

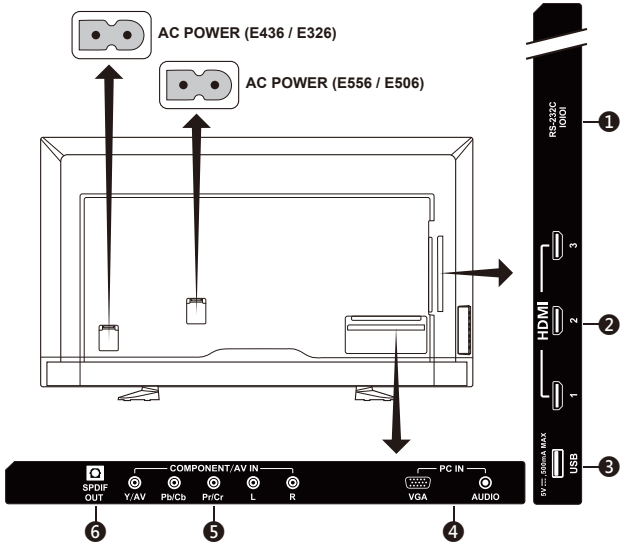

1. **RS-232C** – Connect to your PC, and receive the control commands from the PC.
2. **HDMI (HDMI-1, HDMI-2, HDMI-3)** – Connect to your HDMI devices. HDMI-1 terminal can support ARC (Audio Return Channel) function. ARC output does not work sound effect (Sound mode, Balance, Bass, Treble on OSD).
3. **USB port** – Used for accessing photo, music, and movie files.
4. **PC IN (VGA / AUDIO)** – Connect to your PC video and audio.
5. **COMPONENT / AV IN** –
 - Component: Connect to digital video equipment to the Video Green (Y), Blue (Pb), Red (Pr) jacks, and matching Audio White (L) and Red (R) jacks.
 - Composite: Connect to digital video equipment to the Video Green (AV), jacks, and matching Audio White (L) and Red (R) jacks.
6. **SPDIF OUT**- Use a digital audio cable to connect to stereo home theater system. SPDIF output does not work sound effect (Sound mode, Balance, Bass, Treble on OSD). SPDIF output does not work Auto function of Internal Speakers on OSD.

Once your AV device is connected, press the **Source** button on the remote control to select the relevant source to view. (ex: Press **COMP** button to select “Component” if you have connected a source to the Component input.)



Operating Instructions

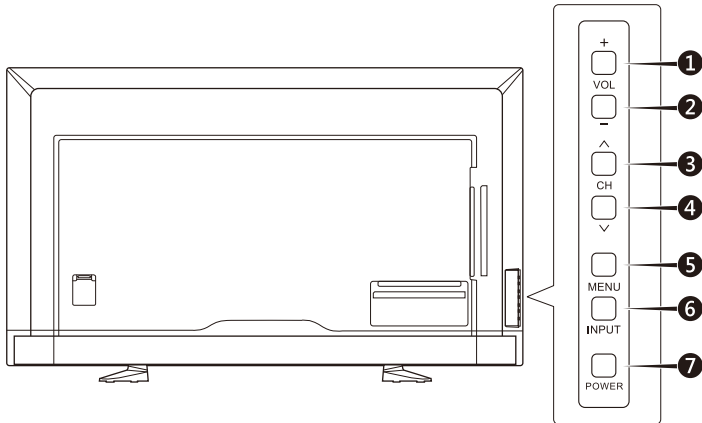

Using The Side Panel Controls

1.	VOL +	Press to increase the volume. Press this button to shift Right in the OSD menu.
2.	VOL -	Press to decrease the volume. Press this button to shift Left in the OSD menu.
3.	CH ^	Press this button to shift up in the OSD menu.
4.	CH v	Press this button to shift down in the OSD menu.
5.	MENU	Press to open or exit the OSD (On-Screen Display) menu.
6.	INPUT	Press to select the input source.
7.	POWER	Press to turn on / off (standby) the display.

Using The Remote Control

(Power)

Press to turn On/Off (standby) the power. (NOTE: To completely turn off the power, unplug the power cord from the power outlet.)

TV

No function.

AV

Press to choose Composite source mode.

COMP

Press to choose Component source mode.

HDMI/PC

Press repeatedly to choose PC IN or HDMI source mode.

0 – 9 / -

No function.

PRE CH

No function.

Source

Press repeatedly to choose the various input sources.

Mute

Switch the sound On/Off.

VOL + / VOL –

Press + or – to adjust the volume.

CH + / CH –

No function.

Exit

Press to exit the OSD menu.

Display

Press to show the information.

FAV

No function.

Menu

Press to open the OSD menu.

▲, ▼, ◀, ▶, OK

Press to select or confirm the various function items on the menu.



◀◀, ■, ▶▶, ▶▶

Use in the USB menu and HDMI CEC function.

MTS

No function.

Wide

Press to choose the display aspect ratio: Normal / Zoom / Wide / Cinema .

Picture

Press to choose the picture mode:
Dynamic / Standard / Energy Savings
/ Theater / Game / Custom.

CH-List

No function.

C C

No function.

Audio

Press to choose sound mode:
Standard / Movie / Music / News /
Custom.

Operating Range for the Remote Control

Point the top of the remote control toward the display's remote sensor during button operation.

Use the remote control within a distance of about 7 m (23 ft.) from remote control sensor or at a horizontal and vertical angle of within 30° within a distance of about 3.5 m (10 ft.).

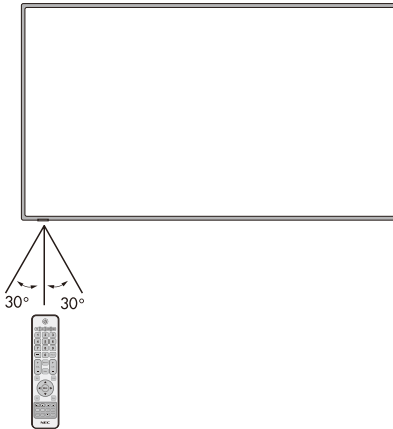
**CAUTION:**

Important, the remote control system may not function when direct sunlight or strong illumination strikes the remote control sensor or when there is an object in the path.

Timing Table

Resolution	VGA	Horizontal		Vertical		Nominal Pixel Clock (MHz)
		Nominal Freq. (kHz)	Sync Polarity	Nominal Freq. (Hz)	Sync Polarity	
640 × 480@60Hz	•	31.469	–	59.94	–	25.175
720 × 400@70Hz	•	31.469	–	70.087	+	28.322
800 × 600@60Hz	•	37.879	+	60.317	+	40
1024 × 768@60Hz	•	48.363	–	60.004	–	65
1280 × 720@60Hz	•	45	–	60	+	74.25
1280 × 800@60Hz	•	49.702	–	59.81	+	83.5
1280 × 1024@60Hz	•	63.98	+	60.20	+	108
1920 × 1080@60Hz	• (Native)	67.5	+	60	+	148.5

Resolution	HDMI	Component
480i 60Hz	•	•
480p 60Hz	•	•
720p 60Hz	•	•
1080i 60Hz	•	•
1080p 24Hz	•	•
1080p 30Hz	•	•
1080p 60Hz	•	•
720p 50Hz	•	•
576p 50Hz	•	•
576i 50Hz	•	•
1080i 50Hz	•	•
1080p 50Hz	•	•

Navigating The On-Screen Menu

Press the **Menu** button to display and **Exit** to close the main menu.

Use the Navigation Ring to navigate, select, adjust or confirm an item on the OSD (On Screen Display) menu.

NOTE: Some features may only be available in a particular source mode.

Video Menu

Video Menu adjusts video items.

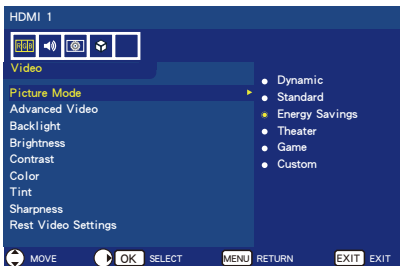

1. Picture Mode

Enter this menu to select from preset picture settings to optimize your display's performance. **Dynamic / Standard / Energy Savings / Theater / Game / Custom.**

2. Advanced Video

Select advanced video settings.

[Aspect Ratio]

Adjust how the picture fills the screen.

[Overscan (On/Off)]

Some video formats may require different scanning modes in order to best display the image. **On:** Image size is larger than what can be displayed. The image edge will appear cropped. Approximately 95% of the image will be shown on the screen.

Off: Image size stays within the display area. The whole image is displayed on the screen.

NOTE: When you use a computer with HDMI out, please set "OFF".

[Dynamic Backlight] (DCR)

Enhance the contrasts between darkness and brightness to optimization the picture.

[Color Temperature]

Select a choice from **Cool, Normal, or Warm.**

[Noise Reduction]

Set to reduce the video noise.

[Adaptive Contrast]

Set to automatically adjust the picture detail and brightness.

3. Backlight

Set the backlight brightness from 0 – 50.

4. Brightness

Adjust picture brightness from 0 – 100.

5. Contrast

Adjust picture contrast from 0 – 100.

6. Color

Adjust picture color from 0 – 100.

7. Tint

Adjust the hue (Red, Green, Blue) of the picture from R50 – G50.

8. Sharpness

Adjust object edges to optimize picture detail from 0 – 100.

9. Reset Video Settings

Reset video settings to factory default settings.

Audio Menu

The Audio menu provides an audio adjustment for user to modify the audio setting.

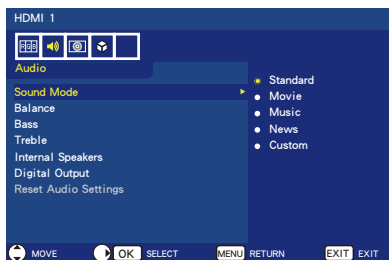

- 1. Sound Mode**
 Select preset audio modes.
Standard / Movie / Music / News / Custom.
- 2. Balance**
 Adjust the audio balance for the display's internal left and right speakers from L50 – R50.
- 3. Bass**
 Enhance the low frequencies.
- 4. Treble**
 Enhance the high frequencies.
- 5. Internal Speakers**
 Select **Off** to turn off the internal speakers.
- 6. Digital Output**
 Select optical output options:
RAW or **PCM** (*Only available for HDMI input source*)
- 7. Reset Audio Settings**
 Reset Audio settings to factory default settings.

Setup Menu

According to various requirements in different source modes, certain features could be hidden (disabled) on the menu.

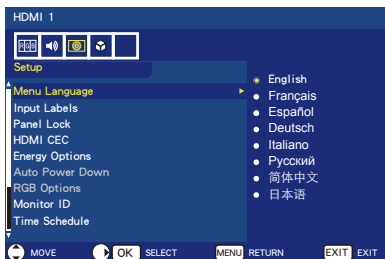

- 1. Menu Language**
 Select the menu display language.
- 2. Input Labels**
 Create labels for the devices connected to your display.
- 3. Panel Lock**
 Lock or unlock all buttons on the display's panel.
- 4. HDMI CEC**
 This function enables you to control the HDMI CEC compliant device connected via the HDMI connector.

[Enable CEC]

Select **On** to enable HDMI CEC.

[Audio Receiver]

Select **On** to enable ARC (Audio Return Channel) function.

ARC is an audio link which can replace other cables between the display and the receiver or speaker system. HDMI-1 terminal can support ARC function.

- [Device List]**
Show the device list.
5. **Energy Options**

Home mode is intended for home use, and will save much energy. In this mode, the display automatically switches to Auto Power save mode and then Auto Standby mode when no external signal is input.

Retail mode is a relatively more energy consuming mode. In this mode, the display does not switch to Auto Power save mode or Auto Standby mode when no external signal is input.

Office mode is between Home mode and Retail mode. In this mode, the display automatically switches to Auto Power save mode but will not continue to switch to Auto Standby mode when no external signal is input.
 6. **Auto Power Down**

Select **On** to enable your display to turn off automatically when you do not press any buttons in 4 hours.
 7. **RGB Options**

(Only available for VGA input, and when there is VGA signal input)

[Auto Adjust]
Automatically adjust the image settings such as position.

[H. Position]
Adjust horizontal position.

[V. Position]
Adjust vertical position.

[Clock]
Set to the minimum level if noise occurs.

[Phase]
Eliminate flicker and distortion.

[Reset RGB Options]
Reset RGB options to factory default settings.
 8. **Monitor ID**

Set the monitor ID number from **1–100, All**, or **Group A–J**.
 9. **Time Schedule**

This function enables your display to turn on and off automatically.

[Schedule Status]
Select **On** to enable Time Schedule.

[Current Time]
Set the current time before using this function.

[Power On]
Set the time for your display to turn on.

[Power Off]
Set the time for your display to turn off.
 10. **Sleep Timer**

Select how long the display will take to automatically turn itself off. **Off / 5 / 10 / 15 / 30 / 60 / 90 / 120 / 180 / 240** (minutes)
 11. **No Signal Menu**

Select how long the No Signal message will display. **Off / 10 seconds / 30 seconds / 1 minutes / 5 minutes / 10 minutes / 15 minutes**
 12. **IR Lock Setting**

Select **On** to lock your remote control, and the remote control will disable to control the display. Press **Display** button for 5 seconds can unlock it.
 13. **System Info**

Indicate the display information.
 14. **Reset AV & Setup**

Reset all **Audio, Video**, and **Setup** settings to factory default settings.

USB Menu

You could browse image, music, or video files from USB storage device.

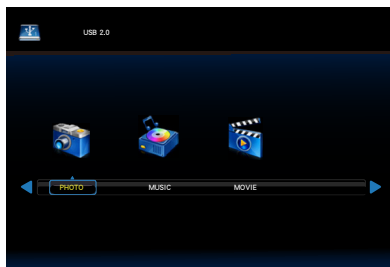

- Press **Exit** button to exit the USB mode or press **Source** button to select other source to exit.

To control while in folder:

- Press **▲**, **▼**, **◀**, **▶** button to browse the files.
- Press **OK** button to open a folder or play the selected file.
- Press **EXIT** button to return to Media Type Select page.

To control the operation bar:

- Press **OK / Menu** button to display operation bar on the bottom of screen.
- Press **Display** button to show the information window.
- Press **◀**, **▶** button to select the item on operation bar.
- Press **EXIT** to hide operation bar.

To control while viewing photos:

- Select **▶** or press **▶▶▶** button to play image slideshow.
- Select **⏸** or press **▶▶▶** button to pause the playing image.
- Select **◀** or press **◀◀◀** button to go to previous image.
- Select **▶** or press **▶▶▶** button to go to next image.
- Select **■** or press **■** button to stop the playing image slideshow.

- Select **🔄** to repeat images in the folder with **Repeat None / Repeat One / Repeat All** options.

Repeat None

After starting playing the files selected in the menu, each file in the same folder is played once in order until the last one.

Also, if you start playing several files checked in the menu, they are played once.

Repeat One

The one file selected or checked in the menu is repeatedly played.









Repeat All

All the files in the same folder are repeatedly played.

Also, if several files are checked in the menu and played, they are repeatedly played.

- Select **🎲** to play images in the folder randomly.
- Select **🎵** to play background music. (The music file should be in the same folder or selected in file browser.)
- Select **📄** to view playlist of images or select a image from the list to play.
- Select **📄** or press **Display** button to show the playing image's information.
- Select **🕒** or **🕒** to rotate the image clockwise or anti-clockwise.
- Select **🖼️** or **🖼️** to switch image size between 4 styles.
- Select **🔍** to scroll the image by remote control. (Only apply to **Zoom 2** and **Zoom 4** styles.)

To control while enjoying musics or videos:

- Select  or press ►|| button to play the file.
- Select  or press ►|| button to pause the playing file.
- Select  to play fast backward. **FB2X / FB4X / FB8X / FB16X / FB32 (Only for video)**
- Select  button to play fast forward. **FF2X / FF4X / FF8X / FF16X / FF32 (Only for video)**
- Select  or press ◀◀ button to go to previous file. When playing video, press once to play from the beginning; press twice to go to previous file.
- Select  or press ▶▶ button to go to next file.
- Select  or press ■ button to stop the playing file.
- Select  to repeat files in the folder with **Repeat None / Repeat One / Repeat All** options.

Repeat None

After starting playing the files selected in the menu, each file in the same folder is played once in order until the last one.

Also, if you start playing several files checked in the menu, they are played once.



Repeat One



The one file selected or checked in the menu is repeatedly played.

Repeat All

All the files in the same folder are repeatedly played.

Also, if several files are checked in the menu and played, they are repeatedly played.

- Select  to loop through a certain part of music or video.
- Select  to play music or video in the folder randomly.
- Select  to view playlist or select a file from the list to play.

- Select  or press **Display** button to show the playing file's information.
- Select  or press **Wide** button to choose the display aspect ratio while playing the video file. **4:3 / 16:9 / Auto**
- Press **Audio** button to choose the audio track.

CAUTION:

- There is no guarantee other than USB Mass storage class devices.
- A JPEG image modified with PC may not be displayed.
- Partly degraded files might be displayed at a reduced resolution.
- Not guaranteed to support all USB devices.
- Do not use a USB Hub.
- Do not support multi-partition USB.

NOTE:

Support USB 2.0 Type A connector (DC5V, max. 500mA). For USB device over 500mA, we suggest to use adaptor or external power.

Data Format for USB

Supported file system	FAT16/32, NTFS
Max. folder layer	9
PHOTO mode	
Data format	JPEG, JPG, JPE
Max. number of photos	1200
Min. image resolution	75 × 75 pixels
Max. image resolution (Progressive DCT)	1,024 × 768 pixels
Max. image resolution (Baseline Sequential DCT)	15,360 × 8,640 pixels
MUSIC mode	
Data format	MP3
Bit rate	32Kbps ~ 320Kbps
MOVIE mode	
Container format	MPG, MPEG, MPEG2-TS, MPEG2-PS, MP4, MKV, AVI, Motion JPEG
Video codec	MPEG1, MPEG2, H.264, JPEG
Audio codec	MPEG Audio Layer 2, MPEG Audio Layer 3, AC-3

USB Demo Mode

The display could automatically play image, music, or video files from USB storage device with USB Demo Mode.

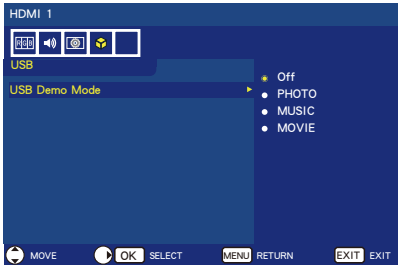

Enable USB Demo Mode

RETAIL mode is set under Energy Options in the on-screen display menu.

USB Demo Mode becomes Enable at RETAIL mode.

- Press **MENU** button to open OSD menu.
- Go to USB page and select USB Demo Mode.
- Select which file type will be played with USB Demo Mode.

Start USB Demo Mode

Demo mode will start automatically when:

- USB Demo Mode is turned on.
- A demo folder named with "NDS_DEMO" is stored on USB storage device.
- The input sources is not set to USB.
- No OSD display on screen except for No signal found.
- No user action more than 8 seconds.

Play files in USB Demo Mode

During demo mode:

- The **Power**, **Volume** and **Mute** buttons on remote control are functional. But all other buttons will interrupt demo play and then return to previous source.
- Removing USB storage device also stops demo play.
- If the display is turned off during demo mode, it will continue demo play when the display is turned on next time (if USB storage device is still plugged).

Maintenance and Recycling

Care Of The Screen

Do not rub or strike the screen with anything hard as this may scratch, mar, or even damage the screen permanently. Unplug the power cord before cleaning the screen. Dust the display by wiping the screen and the cabinet with a soft, clean cloth. If the screen requires additional cleaning, use a clean, damp cloth. Do not use liquid cleaners, aerosol cleaners, or solvents of any kind.

Mobile Telephone Warning

Keep your mobile telephone away from your display to avoid disturbances in the picture or sound, possibly causing permanent damage to your display.

End Of Life Directives

In an effort to produce environmentally friendly products, your new display contains materials that can be recycled and reused. At the end of your displays life, specialized companies can minimize display waste by separating the reusable materials from non-reusable materials. Please ensure you dispose of your display according to local regulations.

Italian Homologation declaration

Questo apparecchio è fabbricato nella Comunità Economica Europea nel rispetto delle disposizioni di cui al D. M. 26/03/92 ed in particolare è conforme alle prescrizioni dell'art. 1 dello stesso D.M. Si dichiara che l'apparecchi.

Manufacturer's Recycling and Energy Information

NEC DISPLAY SOLUTIONS is strongly committed to environmental protection and sees recycling as one of the company's top priorities in trying to minimize the burden placed on the environment. We are engaged in developing environmentally-friendly products, and always strive to help define and comply with the latest independent standards from agencies such as ISO (International Organisation for Standardization) and TCO (Swedish Trades Union).

Disposing of your old NEC product

The aim of recycling is to gain an environmental benefit by means of re-use, upgrading, reconditioning or reclamation of material. Dedicated recycling sites ensure that environmentally harmful components are properly handled and securely disposed. To ensure the best recycling of our products, **NEC DISPLAY SOLUTIONS offers a variety of recycling procedures** and gives advice on how to handle the product in an environmentally sensitive way, once it has reached the end of its life.

All required information concerning the disposal of the product and country-specific information on recycling facilities can be found on our following websites:

<http://www.nec-display-solutions.com/greencompany/> (in Europe),

<http://www.nec-display.com> (in Japan) or

<http://www.necdisplay.com> (in USA).

Energy Saving

This display features an advanced energy saving capability. When a Display Power Management signal is sent to the display, the Energy Saving mode is activated. This display enters into two types of Energy Saving mode during Energy options function sets Home mode. After 10 seconds (Default time) of no signal input, this display will automatically enter into Auto Power save mode (networked Standby mode); and if still no signal input within 30 minutes, this display will automatically enter into Auto Standby mode (general Standby mode).

For additional information visit:

<http://www.necdisplay.com/> (in USA)

<http://www.nec-display-solutions.com/> (in Europe)

<http://www.nec-display.com/global/index.html> (Global)

Mode	Power consumption	LED color
ON Mode (with USB, with Audio)	Approx. 158 W (E656) Approx. 111 W (E556) Approx. 109 W (E506) Approx. 81 W (E436) Approx. 60 W (E326)	None
Energy Saving mode (Auto Power save)	Less than 3.00 W	Blinking Red
Energy Saving mode (Auto Standby)	Less than 0.50 W	Red

WEEE Mark (European Directive 2012/19/EU)



Disposing of your used product: In the European Union

EU-wide legislation as implemented in each Member State requires that used electrical and electronic products carrying the mark (left) must be disposed of separately from normal household waste. This includes monitors and electrical accessories, such as signal cables or power cords. When you dispose of such products, please follow the guidance of your local authority or ask the shop where you purchased

the product, or if applicable, follow applicable legislation or agreement you may have. The mark on electrical and electronic products may only apply to the current European Union Member States.

Outside the European Union

If you wish to dispose of used electrical and electronic products outside the European Union, please contact your local authority and ask for the correct method of disposal.



For EU: The crossed-out wheeled bin implies that used batteries should not be put to the general household waste! There is a separate collection system for used batteries, to allow proper treatment and recycling in accordance with legislation.

According to the EU directive 2006/66/EC, the battery can't be disposed improperly. The battery shall be separated to collect by local service.

Specification

Product Specifications

E656

LCD Module		Resolution: 65"/ 1639.0 mm diagonal Color: 1,920 x 1,080 Over 16 million colors (depending on video card used)
Frequency		Horizontal: 31 – 83KHz (Analog input) 15.625/15.734KHz, 31 – 83KHz (HDMI input) Vertical: 60Hz, 70Hz (Analog input) 24Hz, 30Hz, 50Hz, 60Hz, 70Hz (HDMI input)
Pixel Clock		25 – 156 MHz
Viewable Size		1428.48 (H) x 803.52 (V) mm
Input Signal		
COMPONENT	Component	RCA Y: 1.0 V p-p / 75 ohm, Pb/Pr (Cb/Cr): 0.7 V p-p / 75 ohm
AV IN	Composite	RCA 1.0 V p-p / 75 ohm
VGA	Analog RGB	D-sub 15 pin
HDMI		Type A Connectors
AUDIO		
Audio Input	Analog Audio	Stereo mini jack
Audio Input	AUDIO L / R	RCA 0.5 Vrms / 75 ohm
Audio Output	SPDIF OUT	PCM, Fibre optic
Speaker Output	Internal Speaker:	10 W + 10 W (6 ohm)
Control	RS-232C:	9 Pin D-sub
Power Supply	Auto Power save mode: Auto Standby mode: Power consumption:	1.6 A – 0.8 A @ 100 – 240 V AC, 50/60Hz < 3.00 W < 0.50 W 158 W
Luminance Ratio		65%
Mercury Content		0.0 mg
Presence of Lead		Yes-This display contains lead only in certain parts or components where no technology alternatives exist in accordance with existing exemption clauses under the RoHS Directive
Operational Environment	Temperature: Humidity: Altitude:	0°C – 40°C / 32°F – 104°F 10% – 80% 0 – 2,000 m
Storage Environment	Temperature: Humidity:	-10°C – 60°C / 14°F – 140°F 5% – 85%
Dimension	with Stand and Base: without Stand and Base:	1457.9 (W) x 874.2 (H) x 350(D) mm 1457.9 (W) x 834.5 (H) x 89.5(D) mm
Weight	with Stand and Base: without Stand and Base:	24.33 kg 23.5 kg
VESA compatible mounting interface		400 mm x 400 mm (M6, VESA hole depth 16 mm)
Power Management		VESA DPM
Plug & Play		VESA DDC2B
Accessories		Remote control (1), 1.5 V AAA batteries (2), Power cord (1) (3.0 m), D-sub cable (1) (1.8 m), Setup Manual (1), CD ROM (1)

NOTE:

- All specifications, weights, and dimensions are subject to change without prior notice. Please access www.necdisplay.com for detailed specifications and dimensions for custom installations.
- This model may not be compatible with features and/or specifications that may be added in the future.

E556

LCD Module	Resolution: Color:	55" 1387.8 mm diagonal 1,920 x 1,080 Over 16 million colors (depending on video card used)
Frequency	Horizontal: Vertical:	31 – 83KHz (Analog input) 15.625/15.734KHz, 31 – 83KHz (HDMI input) 60Hz, 70Hz (Analog input) 24Hz, 30Hz, 50Hz, 60Hz, 70Hz (HDMI input)
Pixel Clock		25 – 156 MHz
Viewable Size		1209.6 (H) × 680.4(V) mm
Input Signal		
COMPONENT	Component	RCA Y: 1.0 V p-p / 75 ohm, Pb/Pr (Cb/Cr): 0.7 V p-p / 75 ohm
AV IN	Composite	RCA 1.0 V p-p / 75 ohm
VGA	Analog RGB	D-sub 15 pin
HDMI		Type A Connectors
AUDIO		
Audio Input	Analog Audio	Stereo mini jack
Audio Input	AUDIO L / R	RCA 0.5 Vrms / 75 ohm
Audio Output	SPDIF OUT	PCM, Fibre optic
Speaker Output	Internal Speaker:	10 W + 10 W (6 ohm)
Control	RS-232C:	9 Pin D-sub
Power Supply	Auto Power save mode: Auto Standby mode: Power consumption:	1.2 A – 0.6 A @ 100 – 240 V AC, 50/60Hz < 3.00 W < 0.50 W 111 W
Luminance Ratio		65%
Mercury Content		0.0 mg
Presence of Lead		Yes-This display contains lead only in certain parts or components where no technology alternatives exist in accordance with existing exemption clauses under the RoHS Directive
Operational Environment	Temperature: Humidity: Altitude:	0°C – 40°C / 32°F – 104°F 10% – 80% 0 – 2,000 m
Storage Environment	Temperature: Humidity:	-10°C – 60°C / 14°F – 140°F 5% – 85%
Dimension	with Stand and Base: without Stand and Base:	1239.2 (W) x 749.6 (H) x 255 (D) mm 1239.2 (W) x 711.6 (H) x 79.2 (D) mm
Weight	with Stand and Base: without Stand and Base:	16.1 kg 15.6 kg
VESA compatible mounting interface		400 mm x 200 mm (M6, VESA hole depth 17.5 mm)
Power Management		VESA DPM
Plug & Play		VESA DDC2B
Accessories		Remote control (1), 1.5 V AAA batteries (2), Power cord (1) (3.0 m), D-sub cable (1) (1.8 m), Setup Manual (1), CD ROM (1)

NOTE:

- All specifications, weights, and dimensions are subject to change without prior notice. Please access www.necdisplay.com for detailed specifications and dimensions for custom installations.
- This model may not be compatible with features and/or specifications that may be added in the future.

E506

LCD Module	Resolution: Color:	50" / 1257.3 mm diagonal 1,920 x 1,080 Over 16 million colors (depending on video card used)
Frequency	Horizontal: Vertical:	31 – 83KHz (Analog input) 15.625/15.734KHz, 31 – 83KHz (HDMI input) 60Hz, 70Hz (Analog input) 24Hz, 30Hz, 50Hz, 60Hz, 70Hz (HDMI input)
Pixel Clock		25 – 156 MHz
Viewable Size		1095.8 (H) x 616.4 (V) mm
Input Signal		
COMPONENT	Component	RCA Y: 1.0 V p-p / 75 ohm, Pb/Pr (Cb/Cr): 0.7 V p-p / 75 ohm
AV IN	Composite	RCA 1.0 V p-p / 75 ohm
VGA	Analog RGB	D-sub 15 pin
HDMI		Type A Connectors
AUDIO		
Audio Input	Analog Audio	Stereo mini jack
Audio Input	AUDIO L / R	RCA 0.5 Vrms / 75 ohm
Audio Output	SPDIF OUT	PCM, Fibre optic
Speaker Output	Internal Speaker:	10 W + 10 W (6 ohm)
Control	RS-232C:	9 Pin D-sub
Power Supply	Auto Power save mode: Auto Standby mode: Power consumption:	1.2 A – 0.6 A @ 100 – 240 V AC, 50/60Hz < 3.00 W < 0.50 W 109 W
Luminance Ratio		65%
Mercury Content		0.0 mg
Presence of Lead		Yes-This display contains lead only in certain parts or components where no technology alternatives exist in accordance with existing exemption clauses under the RoHS Directive
Operational Environment	Temperature: Humidity: Altitude:	0°C – 40°C / 32°F – 104°F 10% – 80% 0 – 2,000 m
Storage Environment	Temperature: Humidity:	-10°C – 60°C / 14°F – 140°F 5% – 85%
Dimension	with Stand and Base: without Stand and Base:	1123.6 (W) x 683.7 (H) x 255 (D) mm 1123.6 (W) x 646.7 (H) x 77 (D) mm
Weight	with Stand and Base: without Stand and Base:	13.38 kg 12.88 kg
VESA compatible mounting interface		400 mm x 200 mm (M6, VESA hole depth 15 mm)
Power Management		VESA DPM
Plug & Play		VESA DDC2B
Accessories		Remote control (1), 1.5 V AAA batteries (2), Power cord (1) (3.0 m), D-sub cable (1) (1.8 m), Setup Manual (1), CD ROM (1)

NOTE:

- All specifications, weights, and dimensions are subject to change without prior notice. Please access www.necdisplay.com for detailed specifications and dimensions for custom installations.
- This model may not be compatible with features and/or specifications that may be added in the future.

E436

LCD Module		Resolution: 43" / 1079.9 mm diagonal 1,920 x 1,080 Color: Over 16 million colors (depending on video card used)
Frequency		Horizontal: 31 – 83KHz (Analog input) 15.625/15.734KHz, 31 – 83KHz (HDMI input) Vertical: 60Hz, 70Hz (Analog input) 24Hz, 30Hz, 50Hz, 60Hz, 70Hz (HDMI input)
Pixel Clock		25 – 156 MHz
Viewable Size		941.18 (H) × 529.42 (V) mm
Input Signal		
COMPONENT	Component	RCA Y: 1.0 V p-p / 75 ohm, Pb/Pr (Cb/Cr): 0.7 V p-p / 75 ohm
AV IN	Composite	RCA 1.0 V p-p / 75 ohm
VGA	Analog RGB	D-sub 15 pin
HDMI		Type A Connectors
AUDIO		
Audio Input	Analog Audio	Stereo mini jack
Audio Input	AUDIO L / R	RCA 0.5 Vrms / 75 ohm
Audio Output	SPDIF OUT	PCM, Fibre optic
Speaker Output	Internal Speaker:	10 W + 10 W (6 ohm)
Control	RS-232C:	9 Pin D-sub
Power Supply	Auto Power save mode: Auto Standby mode: Power consumption:	1.0 A – 0.5 A @ 100 – 240 V AC, 50/60Hz < 3.00 W < 0.50 W 81 W
Luminance Ratio		65%
Mercury Content		0.0 mg
Presence of Lead		Yes-This display contains lead only in certain parts or components where no technology alternatives exist in accordance with existing exemption clauses under the RoHS Directive
Operational Environment	Temperature: Humidity: Altitude:	0°C – 40°C / 32°F – 104°F 10% – 80% 0 – 2,000 m
Storage Environment	Temperature: Humidity:	-10°C – 60°C / 14°F – 140°F 5% – 85%
Dimension	with Stand and Base: without Stand and Base:	968.2 (W) x 596.3 (H) x 255 (D) mm 968.2 (W) x 559.4 (H) x 76.8 (D) mm
Weight	with Stand and Base: without Stand and Base:	9.05 kg 8.55 kg
VESA compatible mounting interface		200 mm x 200 mm (M6, VESA hole depth 16 mm)
Power Management		VESA DPM
Plug & Play		VESA DDC2B
Accessories		Remote control (1), 1.5 V AAA batteries (2), Power cord (1) (3.0 m), D-sub cable (1) (1.8 m), Setup Manual (1), CD ROM (1)

NOTE:

- All specifications, weights, and dimensions are subject to change without prior notice. Please access www.necdisplay.com for detailed specifications and dimensions for custom installations.
- This model may not be compatible with features and/or specifications that may be added in the future.

E326

LCD Module	Resolution: Color:	32" / 801.3 mm diagonal 1,920 x 1,080 Over 16 million colors (depending on video card used)
Frequency	Horizontal: Vertical:	31 – 83KHz (Analog input) 15.625/15.734KHz, 31 – 83KHz (HDMI input) 60Hz, 70Hz (Analog input) 24Hz, 30Hz, 50Hz, 60Hz, 70Hz (HDMI input)
Pixel Clock		25 – 156 MHz
Viewable Size		698.4 (H) × 392.85(V) mm
Input Signal		
COMPONENT	Component	RCA Y: 1.0 V p-p / 75 ohm, Pb/Pr (Cb/Cr): 0.7 V p-p / 75 ohm
AV IN	Composite	RCA 1.0 V p-p / 75 ohm
VGA	Analog RGB	D-sub 15 pin
HDMI		Type A Connectors
AUDIO		
Audio Input	Analog Audio	Stereo mini jack
Audio Input	AUDIO L / R	RCA 0.5 Vrms / 75 ohm
Audio Output	SPDIF OUT	PCM, Fibre optic
Speaker Output	Internal Speaker:	5 W + 5 W (6 ohm)
Control	RS-232C:	9 Pin D-sub
Power Supply	Auto Power save mode: Auto Standby mode: Power consumption:	1.1 A – 0.6 A @ 100 – 240 V AC, 50/60Hz < 3.00 W < 0.50 W 60 W
Luminance Ratio		65%
Mercury Content		0.0 mg
Presence of Lead		Yes-This display contains lead only in certain parts or components where no technology alternatives exist in accordance with existing exemption clauses under the RoHS Directive
Operational Environment	Temperature: Humidity: Altitude:	0°C – 40°C / 32°F – 104°F 10% – 80% 0 – 2,000 m
Storage Environment	Temperature: Humidity:	-10°C – 60°C / 14°F – 140°F 5% – 85%
Dimension	with Stand and Base: without Stand and Base:	726.7 (W) x 461.1 (H) x 255 (D) mm 726.7 (W) x 424.3 (H) x 79.8 (D) mm
Weight	with Stand and Base: without Stand and Base:	5.43 kg 4.93 kg
VESA compatible mounting interface		100 mm x 100 mm (M4, VESA hole depth 12.5 mm)
Power Management		VESA DPM
Plug & Play		VESA DDC2B
Accessories		Remote control (1), 1.5 V AAA batteries (2), Power cord (1) (3.0 m), D-sub cable (1) (1.8 m), Setup Manual (1), CD ROM (1)

NOTE:

- All specifications, weights, and dimensions are subject to change without prior notice. Please access www.necdisplay.com for detailed specifications and dimensions for custom installations.
- This model may not be compatible with features and/or specifications that may be added in the future.

RS-232C Port Specifications

PC control of the Display

Attach an RS-232C cable cross-type (commercially available) to the supplied RS-232C for the connections.

NOTE:

This operation system should be used by a person who is accustomed to using computers.

Communication procedure

Send the control commands from the PC via the RS- 232C connector.

The display operates according to the received command and sends a response message to the PC.

Do not send multiple commands at the same time. Wait until the PC receives the response before sending the next command.

Interface

Protocol	RS-232C
Baud rate	9,600 bps
Data length	8 bits
Parity bit	None
Stop bit	1 bit
Communication code	ASCII

This display uses RXD, TXD and GND lines for RS-232C control.

The reverse type cable (null modem cable) (not include) should be used for RS-232C control.

Control command diagram

Function (Monitor ID = 1)	Code Data
Power ON	01 30 41 30 41 30 43 02 43 32 30 33 44 36 30 30 30 31 03 73 0d
Power OFF	01 30 41 30 41 30 43 02 43 32 30 33 44 36 30 30 30 34 03 76 0d
Input Source Select VGA	01 30 41 30 45 30 41 02 30 30 36 30 30 30 30 31 03 73 0d
Input Source Select HDMI-1	01 30 41 30 45 30 41 02 30 30 36 30 30 30 31 31 03 72 0d
Input Source Select HDMI-2	01 30 41 30 45 30 41 02 30 30 36 30 30 30 31 32 03 71 0d
Input Source Select HDMI-3	01 30 41 30 45 30 41 02 30 30 36 30 30 30 31 33 03 70 0d
Input Source Select Component	01 30 41 30 45 30 41 02 30 30 36 30 30 30 30 43 03 01 0d
Input Source Select Composite	01 30 41 30 45 30 41 02 30 30 36 30 30 30 30 35 03 77 0d
Input Source USB	01 30 41 30 45 30 41 02 30 30 36 30 30 30 31 34 03 77 0d
Sound Mute ON	01 30 41 30 45 30 41 02 30 30 38 44 30 30 30 31 03 09 0d
Sound Mute OFF	01 30 41 30 45 30 41 02 30 30 38 44 30 30 30 32 03 0a 0d

Supporting HDMI CEC command

HDMI CEC command name	Explanation
One Touch Play	If HDMI CEC supporting devices are turned on, the display that connected the devices by HDMI cable is also turned on automatically then changed Input to HDMI. If the display is turned on when HDMI CEC devices are turned on, it changed input to HDMI.
Remote Control Pass Through	The display's wireless remote control button operation is functioning to HDMI CEC supporting devices. For example, if turn on the display by wireless remote control and press play back button, HDMI CEC supporting devices will also be turn on and play back.
Power Status	Connected HDMI CEC supporting devices obtains the display's power status such as the display is in standby mode or on.
System Information	This function obtains the information of a connected HDMI CEC supporting device (CEC version, Physical Address). In addition, this function copes with "Change Language function". If the language using at the display is changed, the language at connected HDMI CEC supporting device is changed to the same language that selected at the display. As for the "Change Language function", it is necessary that the connected HDMI CEC supporting device to cope a multilanguage.
System Standby	If turn off the display by wireless remote control supplied with the display, HDMI CEC supporting devices are also turned off at the same time. If turn off the display while a HDMI CEC supporting device is recording, the device is kept on. Please refer to the user's manual supplied with the HDMI CEC supporting device for more detail.
System Audio Control	The function sends digital audio signal through HDMI cable. Please set audio amplifier between the display and HDMI CEC supporting devices with HDMI cable. The Volume button on the wireless remote control is also controlling volume of the connected audio amplifier. While this function is active, internal speaker or external speaker connected to the display will be MUTE.
Device OSD Name Transfer	This function obtains the connected HDMI CEC supporting device's name.
Routing Control	By selecting device name, HDMI CEC supporting device input can be switched. After selecting the device, wireless remote control operation is functioning to the selected device.

CEC is an abbreviation of Consumer Electronics Control.

NOTE:

- Depending on the connected device, sometimes the device does not work properly.

Before Calling Service

Please make these simple checks before calling service. These tips may save you time and money as charges for receiver installation and adjustments of customer controls are not covered under your warranty.

Symptoms	Items To Check And Actions To Follow
No power	<ul style="list-style-type: none"> • Check to see if the display's AC power cord is plugged into the outlet. • Unplug the display and after 60 seconds reinsert the plug into the outlet and power on the display.
No picture	<ul style="list-style-type: none"> • Adjust the contrast and brightness settings.
Good picture but no sound	<ul style="list-style-type: none"> • Increase the volume. • Confirm that the display is not muted by pressing the Mute button on the remote control.
Good sound but poor color	<ul style="list-style-type: none"> • Adjust the contrast, color and brightness settings.
Poor picture	<ul style="list-style-type: none"> • Poor picture quality may occur when an activated S-VHS camera or camcorder is connected to your display and another peripheral at the same time. Switch off one of the peripherals.
Presence of a horizontal dotted line	<ul style="list-style-type: none"> • This may be caused by electrical interference (e.g. hair-dryer, nearby neon lights, etc.). • Power cycle the equipment by turning off and then turning back on.
Display not responding via the remote control	<ul style="list-style-type: none"> • Determine if the batteries are working and replace batteries if necessary. • Clean the remote control sensor lens on the display. • If necessary, utilize the buttons located on the side of the display.

Glossary

HDMI Inputs

High-Definition Multimedia Interface Audio / Video Inputs are located on the receiver. These connectors are used for the input of audio and video signals. Designed to receive higher picture resolution and offer sound connection options.

Menu

An on-screen listing of features shown on the display screen is made available for user adjustments.

Sleep Timer

You can set a time period for which the display will automatically turn off.