

ST-TM40 with V552 OUTLINE

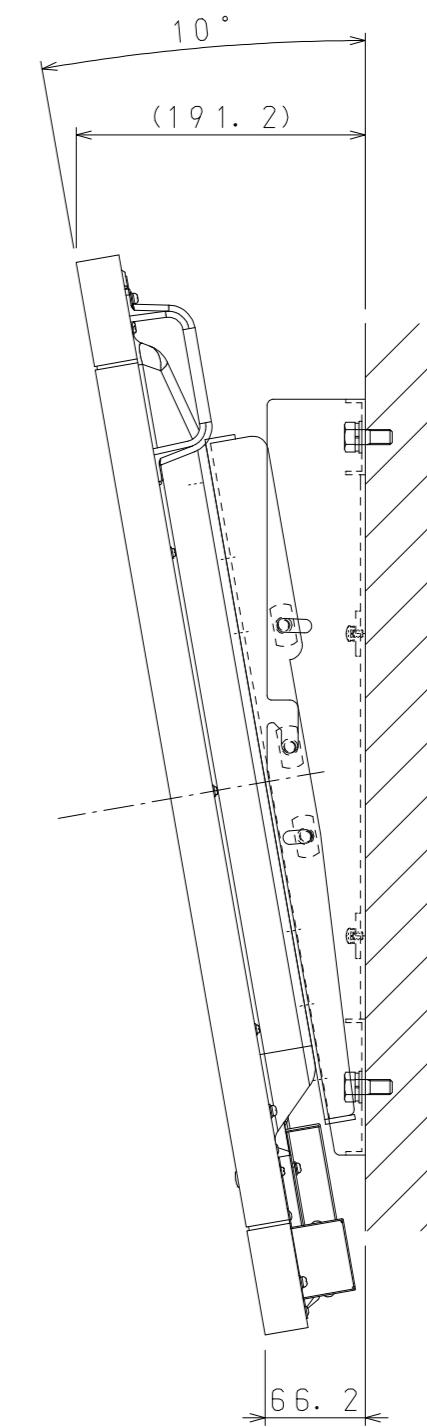
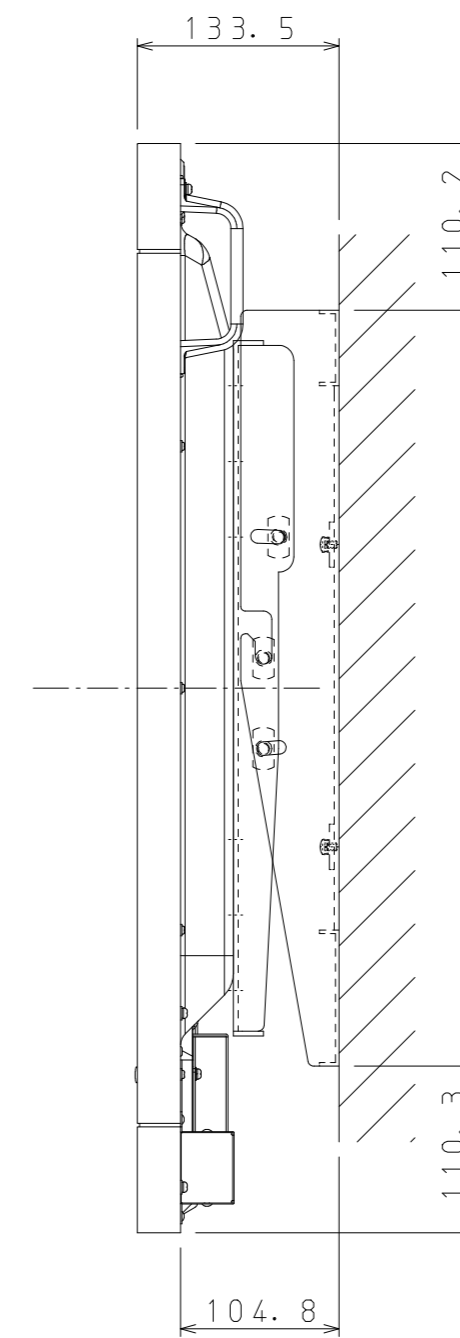
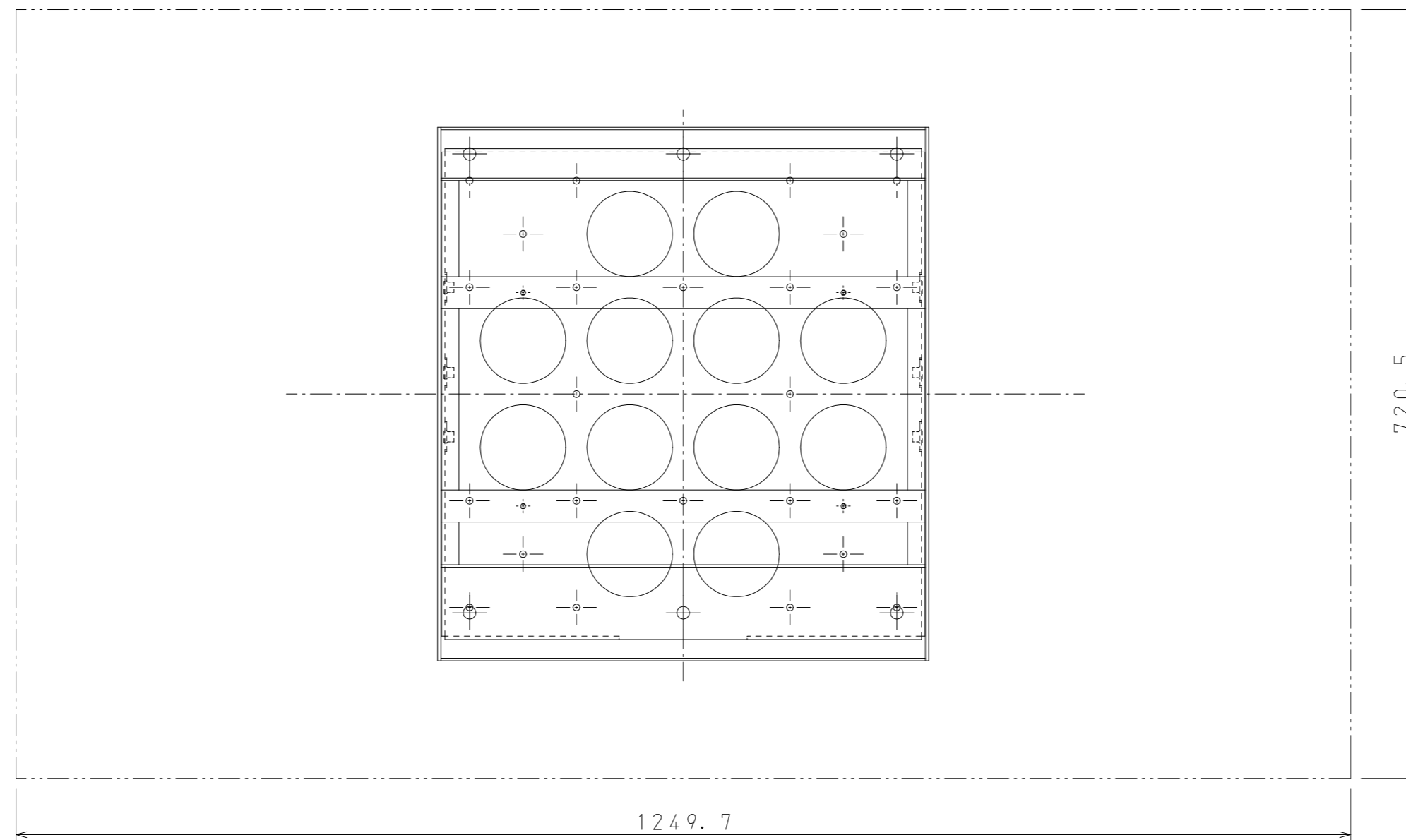
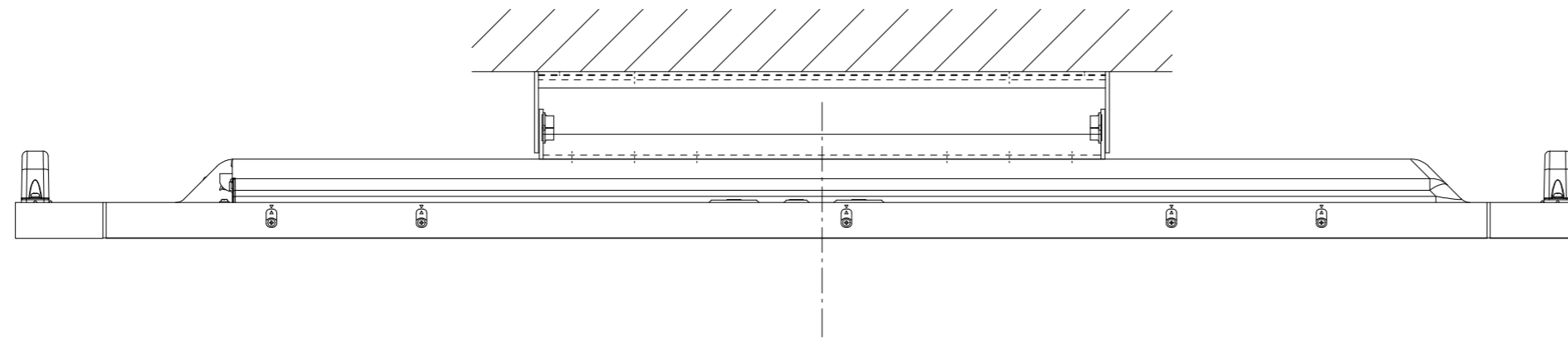

注. 二点鎖船部内は、放熱口を示す