

*LCD Projector*

# ***NP2000/NP1000***

---

*User's Manual*



- IBM is a trademark or registered trademark of International Business Machines Corporation.
- Macintosh, Mac OS X and PowerBook are trademarks of Apple Computer, Inc., registered in the U.S. and other countries.
- Windows, Windows 98, Windows Me, Windows XP or Windows 2000 are trademarks or registered trademarks of Microsoft Corporation.
- Ulead is a trademark and/or registered trademark of Ulead Systems, Inc.
- PJLink is a registered and pending trademark in Japan, the United States of America and other countries.
- Other product and company names mentioned in this user's manual may be the trademarks or registered trademarks of their respective holders.

## **NOTES**

- (1) The contents of this guide may not be reprinted in part or whole without permission.
- (2) The contents of this guide are subject to change without notice.
- (3) Great care has been taken in the preparation of this manual; however, should you notice any questionable points, errors or omissions, please contact us.
- (4) Notwithstanding article (3), NEC will not be responsible for any claims on loss of profit or other matters deemed to result from using the Projector.

# Important Information

## Safety Cautions

### Precautions

Please read this manual carefully before using your NEC NP2000/NP1000 projector and keep the manual handy for future reference. Your serial number is located on the right side of your projector. Record it here:

#### CAUTION



To turn off main power, be sure to remove the plug from power outlet.  
The power outlet socket should be installed as near to the equipment as possible, and should be easily accessible.

#### CAUTION



TO PREVENT SHOCK, DO NOT OPEN THE CABINET.  
THERE ARE HIGH-VOLTAGE COMPONENTS INSIDE.  
REFER SERVICING TO QUALIFIED SERVICE PERSONNEL.



This symbol warns the user that uninsulated voltage within the unit may be sufficient to cause electrical shock. Therefore, it is dangerous to make any kind of contact with any part inside of the unit.



This symbol alerts the user that important information concerning the operation and maintenance of this unit has been provided.  
The information should be read carefully to avoid problems.

**WARNING: TO PREVENT FIRE OR SHOCK, DO NOT EXPOSE THIS UNIT TO RAIN OR MOISTURE.  
DO NOT USE THIS UNIT'S PLUG WITH AN EXTENSION CORD OR IN AN OUTLET UNLESS ALL THE PRONGS CAN BE FULLY INSERTED.**

### DOC Compliance Notice (for Canada only)

This Class B digital apparatus meets all requirements of the Canadian Interference-Causing Equipment Regulations.

### Acoustic Noise Information Ordinance-3. GSGV (for Germany only):

The sound pressure level is less than 70 dB (A) according to ISO 3744 or ISO 7779.

<b>CAUTION</b> 注意 <b>CAUTION</b> LASER RADIATION DO NOT STARE INTO BEAM WAVE LENGTH: 650nm MAX. OUTPUT: 1mW CLASS II LASER PRODUCT CLASS 2 LASER PRODUCT EN60825-1:1994+A2:2001+A1:2002, IIS C 6802:1998 IEC 60825-1:1993+A1:1997+A2:2001	<b>RADIACION LASER NO</b> MIRE AL RAYO PRODUCTO LASER CLASSE2 LASER-STRAHLUNG NICHT IN DEN STRAHL BLICKEN! LASER KLASSE2	<b>RAYONNEMENT LASER NE PAS</b> REGARDEZ DANS LE FAISCEAU APPAREIL A LASER DE CLASSE2 レーザー光 1mW max. 650nm ビームをのぞきまなないこと クラス2レーザー製品	激光辐射 勿直视 激光束 激光产品 MADE IN CHINA 中国製造
---	---	--	--



This label is on the side of the remote control.

This mark is on the top of the remote control.

#### CAUTION



Use of controls or adjustments or performance of procedures other than those specified herein may result in hazardous radiation exposure.

#### CAUTION



Do not look into the laser pointer while it is on and do not point the laser beam at a person. Serious injury could result.

#### CAUTION



Avoid displaying stationary images for a prolonged period of time.  
Doing so can result in these images being temporarily sustained on the surface of the LCD panel.  
If this should happen, continue to use your projector. The static background from previous images will disappear.

### WARNING TO CALIFORNIA RESIDENTS:

Handling the cables supplied with this product, will expose you to lead, a chemical known to the State of California to cause birth defects or other reproductive harm. Wash hands after handling.

### Disposing of your used product



EU-wide legislation as implemented in each Member State requires that used electrical and electronic products carrying the mark (left) must be disposed of separately from normal household waste. This includes projectors and their electrical accessories or lamps. When you dispose of such products, please follow the guidance of your local authority and/or ask the shop where you purchased the product.

After collecting the used products, they are reused and recycled in a proper way. This effort will help us reduce the wastes as well as the negative impact such as mercury contained in a lamp to the human health and the environment at the minimum level.

The mark on the electrical and electronic products only applies to the current European Union Member States.



### RF Interference (for USA only)

#### WARNING

The Federal Communications Commission does not allow any modifications or changes to the unit EXCEPT those specified by NEC Display Solutions of America, Inc. in this manual. Failure to comply with this government regulation could void your right to operate this equipment. This equipment has been tested and found to comply with the limits for a Class B digital device, pursuant to Part 15 of the FCC Rules. These limits are designed to provide reasonable protection against harmful interference in a residential installation. This equipment generates, uses, and can radiate radio frequency energy and, if not installed and used in accordance with the instructions, may cause harmful interference to radio communications. However, there is no guarantee that interference will not occur in a particular installation.

If this equipment does cause harmful interference to radio or television reception, which can be determined by turning the equipment off and on, the user is encouraged to try to correct the interference by one or more of the following measures:

- Reorient or relocate the receiving antenna.
- Increase the separation between the equipment and receiver.
- Connect the equipment into an outlet on a circuit different from that to which the receiver is connected.
- Consult the dealer or an experienced radio / TV technician for help.

For UK only: In UK, a BS approved power cable with moulded plug has a Black (five Amps) fuse installed for use with this equipment. If a power cable is not supplied with this equipment please contact your supplier.

### Important Safeguards

These safety instructions are to ensure the long life of your projector and to prevent fire and shock. Please read them carefully and heed all warnings.

#### Installation

- Do not place the projector in the following conditions:
  - on an unstable cart, stand, or table.
  - near water, baths or damp rooms.
  - in direct sunlight, near heaters or heat radiating appliances.
  - in a dusty, smoky or steamy environment.
  - on a sheet of paper or cloth, rugs or carpets.
- If you wish to have the projector installed on the ceiling:
  - Do not attempt to install the projector yourself.
  - The projector must be installed by qualified technicians in order to ensure proper operation and reduce the risk of bodily injury.
  - In addition, the ceiling must be strong enough to support the projector and the installation must be in accordance with any local building codes.
  - Please consult your dealer for more information.

### Place the projector in a horizontal position

The tilt angle of the projector should not exceed 10 degrees, nor should the projector be installed in any way other than the desktop and ceiling mount, otherwise lamp life could decrease dramatically.



### **Fire and Shock Precautions**

- Ensure that there is sufficient ventilation and that vents are unobstructed to prevent the build-up of heat inside your projector. Allow at least 4 inches (10cm) of space between your projector and a wall.
- Do not try to touch the ventilation outlet on the left front (when seen from the front) as it can become heated while the projector is turned on.
- Prevent foreign objects such as paper clips and bits of paper from falling into your projector. Do not attempt to retrieve any objects that might fall into your projector. Do not insert any metal objects such as a wire or screwdriver into your project. If something should fall into your projector, disconnect it immediately and have the object removed by a qualified service personnel.
- Do not place any objects on top of the projector.
- Do not touch the power plug during a thunderstorm. Doing so can cause electrical shock or fire.
- The projector is designed to operate on a power supply of 100-240V AC 50/60 Hz. Ensure that your power supply fits this requirement before attempting to use your projector.
- Do not look into the lens while the projector is on. Serious damage to your eyes could result.
- Keep any items such as magnifying glass out of the light path of the projector. The light being projected from the lens is extensive, therefore any kind of abnormal objects that can redirect light coming out of the lens, can cause unpredictable outcome such as fire or injury to the eyes.
- Do not cover the lens with the black lens cap or equivalent while the projector is on. Doing so can lead to melting of the cap and possibly burning your hands due to the heat emitted from the light output.
- Do not place any objects, which are easily affected by heat, in front of the projector lens or a projector exhaust vent. Doing so could lead to the object melting or getting your hands burned from the heat that is emitted from the light output and exhaust.
- Handle the power cable carefully. A damaged or frayed power cable can cause electric shock or fire.
  - Do not use any power cables than the supplied one.
  - Do not bend or tug the power cable excessively.
  - Do not place the power cable under the projector, or any heavy object.
  - Do not cover the power cable with other soft materials such as rugs.
  - Do not heat the power cable
  - Do not handle the power plug with wet hands.
- Turn off the projector, unplug the power cable and have the object removed by a qualified NEC service personnel under the following conditions:
  - When the power cable or plug is damaged or frayed.
  - If liquid has been spilled into the projector, or if it has been exposed to rain or water.
  - If the projector does not operate normally when you follow the instructions described in this user's manual.
  - If the projector has been dropped or the cabinet has been damaged.
  - If the projector exhibits a distinct change in performance, indicating a need for service.
  - If the projector is not to be used for an extended period of time.
- Disconnect the power cable and any other cables before carrying the projector
- Turn off the projector and unplug the power cable before cleaning the cabinet or replacing the lamp.
- When using a LAN cable:
  - For safety, do not connect to the connector for peripheral device wiring that might have excessive voltage.

### CAUTION

- Always carry your projector by the carrying handle. Before doing so, be sure to lock the carrying handle in place. To lock the carrying handle, see "To lock the carrying handle" on page 6.
- Do not use the tilt-foot for purposes other than originally intended. Misuses such as using the tilt foot to carry or hang (from the wall or ceiling) the projector can cause damage to the projector.
- Do not send the projector in a soft case by parcel delivery service or cargo shipment. The projector inside the soft case could be damaged.
- Select [High] in Fan mode if you continue to use the projector for consecutive days. (From the menu, select [Setup - Options] → [Fan Mode] → [High].)
- Before using Direct Power Off, be sure to allow at least 20 minutes immediately after turning on the projector and starting to display an image.
- Do not unplug the power cable from the wall outlet or projector when the projector is powered on. Doing so can cause damage to the AC IN connector of the projector and (or) the prong plug of the power cable. To turn off the AC power supply when the projector is powered on, use a power strip equipped with a switch and a breaker.
- The projector can be unplugged during its cool down period after it is turned off. Do not try to touch the ventilation outlet on the left front (when seen from the front) as it can become heated while the projector is turned on and immediately after the projector is turned off.
- Do not turn off the AC power for 60 seconds after the lamp is turned on and while the POWER indicator is blinking green. Doing so could cause premature lamp failure.

### Caution on Handling the Optional Lens

When shipping the projector with the optional lens, remove the optional lens before shipping the projector. The lens and the lens shift mechanism may encounter damage caused by improper handling during transportation.

### Remote Control Precautions

- Handle the remote control carefully.
- If the remote control gets wet, wipe it dry immediately.
- Avoid excessive heat and humidity.
- Do not heat, take apart, or throw batteries into fire.
- If you will not be using the remote control for a long time, remove the batteries.
- Ensure that you have the batteries' polarity (+/-) aligned correctly.
- Do not use new and old batteries together, or use different types of batteries together.
- Dispose of used batteries according to your local regulations.

### Lamp Replacement

- To replace the lamp, follow all instructions provided on page 110.
- Be sure to replace the lamp when the message **[The lamp has reached the end of its usable life. Please replace the lamp.]** appears. If you continue to use the lamp after the lamp has reached the end of its usable life, the lamp bulb may shatter, and pieces of glass may be scattered in the lamp case. Do not touch them as the pieces of glass may cause injury.

If this happens, contact your dealer for lamp replacement.

### A Lamp Characteristic

The projector has a high-pressure mercury lamp as a light source.

A lamp has a characteristic that its brightness gradually decreases with age. Also repeatedly turning the lamp on and off will increase the possibility of its lower brightness.

### CAUTION:

When removing the lamp from a ceiling-mounted projector, make sure that no one is under the projector. Glass fragments could fall if the lamp has been burned out.

# Table of Contents

---

<b>Important Information</b> .....	i
<b>1. Introduction</b> .....	1
<b>1</b> What's in the Box? .....	1
<b>2</b> Introduction to the Projector .....	2
Congratulations on Your Purchase of the Projector .....	2
Features you'll enjoy .....	2
About this user's manual .....	3
<b>3</b> Part Names of the Projector .....	4
Front/Top .....	4
Rear .....	4
Bottom .....	5
Carrying the Projector .....	5
Top Features .....	7
Terminal Panel Features .....	8
<b>4</b> Part Names of the Remote Control .....	9
Battery Installation .....	10
Operating Range for Wireless Remote Control .....	10
Remote Control Precautions .....	10
Using the Remote Control in Wired Operation .....	11
<b>2. Installation and Connections</b> .....	12
<b>1</b> Setting Up the Screen and the Projector .....	12
Selecting a Location .....	12
<b>2</b> Making Connections .....	13
Connecting Your PC or Macintosh Computer .....	13
When Viewing a DVI Digital Signal .....	14
To connect SCART output (RGB) .....	15
Connecting an External Monitor .....	16
Connecting Your DVD Player with Component Output .....	17
Connecting Your VCR or Laser Disc Player .....	18
Connecting to a Network .....	19
Inserting and Removing a PC Card .....	21
PC Card Type .....	22
Connecting the Supplied Power Cable .....	23
<b>3. Projecting an Image (Basic Operation)</b> .....	24
<b>1</b> Turning on the Projector .....	24
Note on Startup screen (Menu Language Select screen) .....	25
<b>2</b> Selecting a Source .....	26
Selecting the computer or video source .....	26
<b>3</b> Adjusting the Picture Size and Position .....	27
Adjusting the Position of a Projected Image .....	28
Adjusting the focus (Focus ring) .....	29
Finely adjusting the size of an image (Zoom lever) .....	29
Adjusting the Tilt Foot .....	30
<b>4</b> Correcting Keystone Distortion .....	31
<b>5</b> Optimizing an RGB Image Automatically .....	33
Adjusting the Image Using Auto Adjust .....	33

⑥	Adjusting Volume Up & Down .....	33
⑦	Using the Laser Pointer .....	34
	Setting the function switch .....	34
⑧	Turning off the Projector .....	35
⑨	After Use .....	35
<b>4.</b>	<b>Convenient Features .....</b>	<b>36</b>
①	Turning Off the Image and Sound .....	36
②	Freezing a Picture .....	36
③	Enlarging and Moving a Picture .....	36
④	Changing Lamp Mode .....	36
⑤	Getting Integrated Help .....	37
⑥	Using a USB Mouse .....	38
⑦	Using the Optional Remote Mouse Receiver .....	39
⑧	Correcting Horizontal and Vertical Keystone Distortion (Cornerstone) .....	41
⑨	Making Freehand Drawings on a Projected Image (ChalkBoard) .....	44
⑩	Preventing Unauthorized Use of the Projector .....	45
⑪	Operation Using an HTTP Browser .....	50
⑫	Using the Projector to Operate a Computer Connected on a Network (Desktop Control Utility 1.0) .....	53
<b>5.</b>	<b>Using the Viewer .....</b>	<b>58</b>
①	Making the Most out of the Viewer Function .....	58
②	Saving data to a PC card or USB memory device .....	59
	Using Ulead Photo Explorer 8.0 .....	59
	Using Windows Explorer to save files .....	59
③	Operating the Viewer Function from the Projector (playback) .....	60
	Projecting slides (Viewer) .....	60
	Operating Viewer Menu .....	60
	Viewer Window Elements .....	61
	Setting Option for Viewer .....	62
	Exiting Viewer .....	63
	Viewing Digital Images .....	63
④	Changing Background Logo .....	64
<b>6.</b>	<b>Using On-Screen Menu .....</b>	<b>65</b>
①	Using the Menus .....	65
②	Menu tree .....	66
③	Menu Elements .....	68
④	Menu Descriptions & Functions [Source] .....	69
	Computer 1 and 2 .....	69
	Computer 3 (RGB Digital) .....	69
	Component .....	69
	Video .....	69
	S-Video .....	69
	Viewer .....	69
	LAN .....	69
	[Entry List] .....	70

<b>5</b>	Menu Descriptions & Functions [Adjust] .....	72
	[Picture] .....	72
	[Image Options] .....	75
	[Video] .....	78
	[Sound] .....	79
<b>6</b>	Menu Descriptions & Functions [Setup] .....	80
	[Basic] .....	80
	[Menu] .....	82
	[Security] .....	82
	[Installation] .....	87
	[Options] .....	97
	[Tools] .....	99
<b>7</b>	Menu Descriptions & Functions [Information] .....	103
	[Usage Time] .....	103
	[Source Page1] .....	104
	[Source Page2] .....	104
	[LAN Built-in] .....	105
	[LAN PC Card] .....	105
	[LAN Wireless] .....	106
	[Version] .....	106
<b>8</b>	Menu Descriptions & Functions [Reset] .....	107
	Returning to Factory Default .....	107
<b>7.</b>	<b>Maintenance</b> .....	108
<b>1</b>	Cleaning or Replacing the Filter .....	108
<b>2</b>	Cleaning the Cabinet and the Lens .....	109
<b>3</b>	Replacing the Lamp .....	110
<b>8.</b>	<b>Using Optional Lenses</b> .....	113
<b>1</b>	Table of Throw Distances and Screen Sizes for Optional Lenses .....	113
<b>2</b>	Lens Shift Adjustable Range .....	114
<b>3</b>	Replacing with Optional Lens .....	115
<b>9.</b>	<b>Appendix</b> .....	117
<b>1</b>	Troubleshooting .....	117
<b>2</b>	Specifications .....	120
<b>3</b>	Cabinet Dimensions .....	122
<b>4</b>	Screen Size and Projection Distance .....	123
<b>5</b>	Pin Assignments of D-Sub COMPUTER 1 Input Connector .....	125
<b>6</b>	Compatible Input Signal List .....	126
<b>7</b>	PC Control Codes and Cable Connection .....	127
<b>8</b>	Using Software Keyboard .....	128
<b>9</b>	Troubleshooting Check List .....	129
<b>10</b>	TravelCare Guide .....	131

# 1. Introduction

## ① What's in the Box?

Make sure your box contains everything listed. If any pieces are missing, contact your dealer. Please save the original box and packing materials if you ever need to ship your Projector.

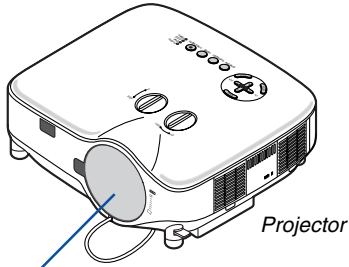

Lens cap  
(24FT9741)

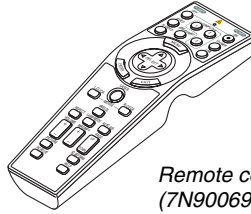

Remote control  
(7N900692)

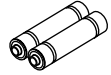

Batteries (AA x 2)

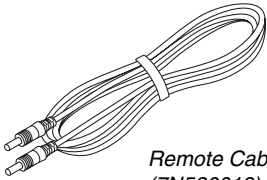

Remote Cable  
(7N520019)

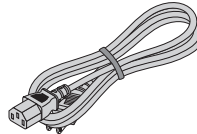

Power cable  
(7N080204) US  
(7N080008) EU

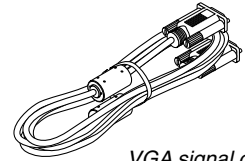

VGA signal cable  
(7N520054)

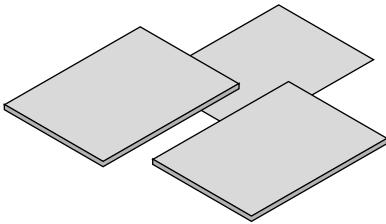

- Important Information
- Quick Setup Guide
- Wired and Wireless Network Setup Guide

### For North America only

Registration card  
Limited warranty

### For Europe only

Guarantee policy

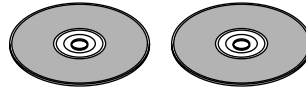

CD-ROM  
User's manual and User Supportware 3

- Security sticker
- PC card lock (24F42201)
- Anti-theft screw for lens x 1 (24V00841)



## ② Introduction to the Projector

This section introduces you to the NP2000/NP1000 projector and describes key features and controls.

### Congratulations on Your Purchase of the Projector

The NP2000/NP1000 is a sophisticated XGA projector that produces an enhanced display. With the NP2000/NP1000 you will be able to project images up to 500" (measured diagonally). Enjoy crisp and sharp large screen display from your PC, workstation or Macintosh computer, DVD player, VCR, satellite hookup, HDTV source, ) and images from your digital camera PC Card, compact flash memory or USB storage device. The NP2000/NP1000 provides for enhanced security options to help deter projector theft and provides for full projector control through the PC control port (D-Sub 9 Pin) and LAN support. With input and output flexibility, long lamp life and a full function remote, the NP2000/NP1000 lets you enjoy larger than life viewing from a compact and easy to setup and use projector.

### Features you'll enjoy :

- **LCD projector with high resolution and high brightness**

High resolution display - up to UXGA compatible, XGA native resolution.

- **Extensive optional lens**

One standard lens and five types of optional lenses are available

- **Lens shift mechanism offers installation flexibility**

Manual lens shift that can be adjusted by turning dials on the top of the projector

- **Direct Power Off & Auto Start**

The projector has a feature called "Direct Power Off". This feature allows the projector to be turned off (even when projecting an image) using a power strip equipped with a switch and a breaker.

---

*NOTE: Before using Direct Power Off, be sure to allow at least 20 minutes immediately after turning on the projector and starting to display an image.*

*Also, the power cable can be removed immediately after turning off the projector.*

---

Auto Start eliminates the need to always use the POWER (ON/STANDBY) button on the remote control or projector cabinet.

- **Integrated RJ-45 connector for wired networking capability and wireless networking capable**

Present from anywhere in the room when using as a wireless LAN projector and five software contained on the supplied User Supportware 3 CD-ROM, no physical signal cable connection to a PC is required.

\* The NEC optional wireless LAN card is required (NWL-100\* See page 89).

- **A variety of input ports and a comprehensive array of system control interfaces**

This projector supports input signals including BNC, DVI-D, analogue RGB, component, S-video, and composite.

- **Wall Color Correction**

Built-in Wall Color Correction presets provide for adaptive color correction when projecting onto non-white screen material (or a wall).

- **Six picture preset modes for user adjustable picture and color settings**

Each picture preset mode can be customized and memorized according to your preference.

- **Preventing unauthorized use of the projector**

Enhanced smart security settings for password protection, cabinet control panel lock, menu lock and PC card protection key to help prevent unauthorized access, adjustments and theft deterrence.



- Free downloadable Software Geometric Correction Tool 3.0.  
Corrects the geometry of an image projected onto a cylindrical, spherical or corner screen via serial connection.  
For additional information visit:  
US : <http://www.necdisplay.com/>  
Europe : <http://www.nec-display-solutions.com/>  
Global : <http://www.nec-pj.com/>

### **About this user's manual**

The fastest way to get started is to take your time and do everything right the first time. Take a few minutes now to review the user's manual. This may save you time later on. At the beginning of each section of the manual you'll find an overview. If the section doesn't apply, you can skip it.

### 3 Part Names of the Projector

#### Front/Top

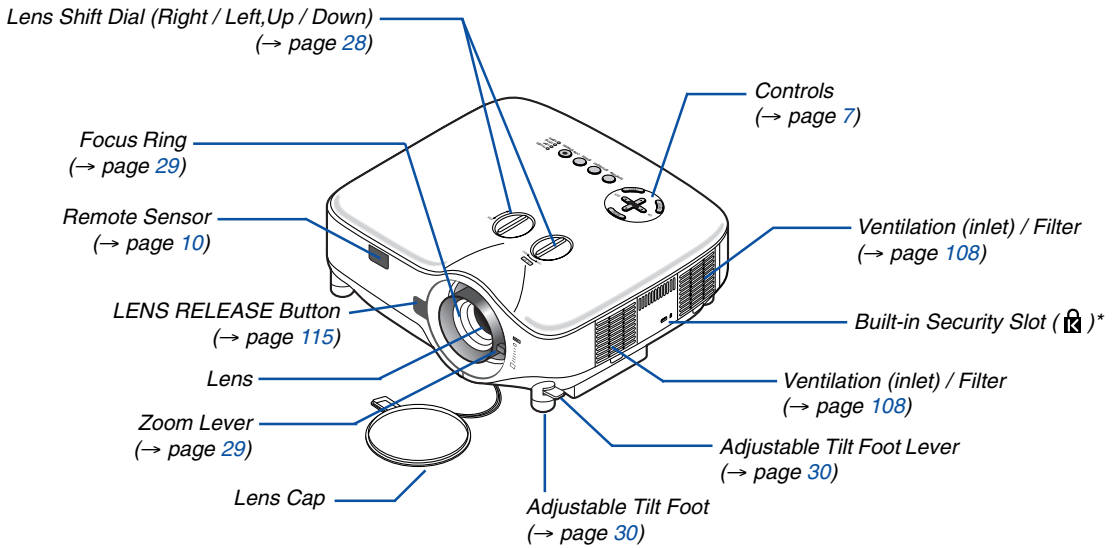

\* This security slot supports the MicroSaver® Security System. MicroSaver® is a registered trademark of Kensington Microware Inc. The logo is trademarked and owned by Kensington Microware Inc.

#### Rear

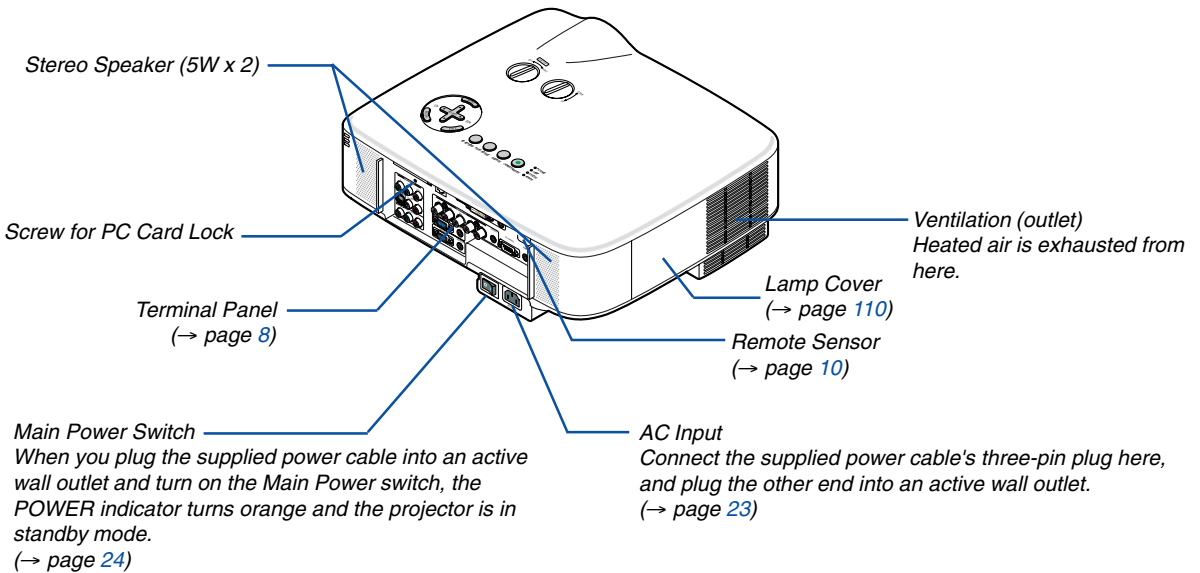

**Bottom**

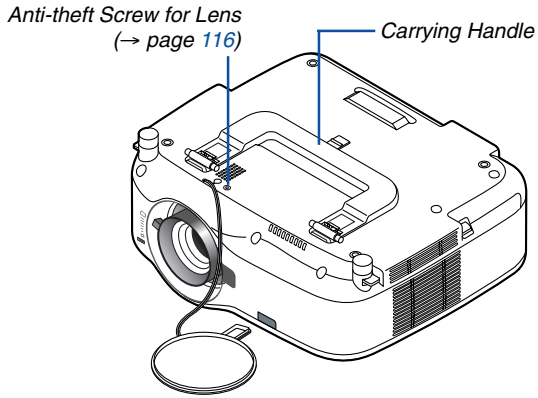

**Carrying the Projector**

Always carry your projector by the handle.

Ensure that the power cable and any other cables connecting to video sources are disconnected before moving the projector.

When moving the projector or when it is not in use, cover the lens with the lens cap.

---

*NOTE: To stand the projector on its end, do so by holding the cabinet, not by holding the carrying handle. Doing so can cause damage to the carrying handle.*

---

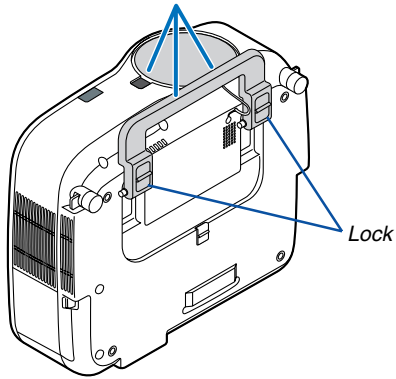

**To lock the carrying handle**

*1. Carefully place the projector on its end.*

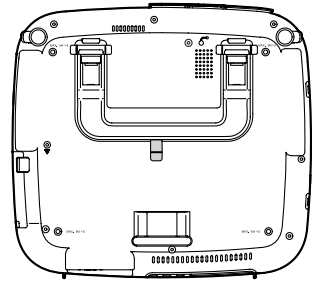

*2. Pull up the carrying handle with the catch pressed down.*

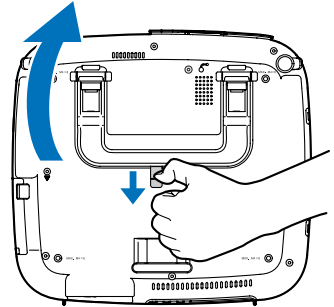

*3. Press down the left and right locks to set the carrying handle in place.*

- To place back the carrying handle, press up the left and right locks and pull down the carrying handle.

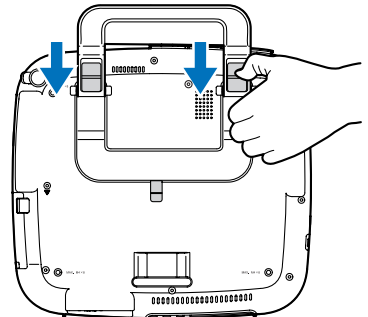

Top Features

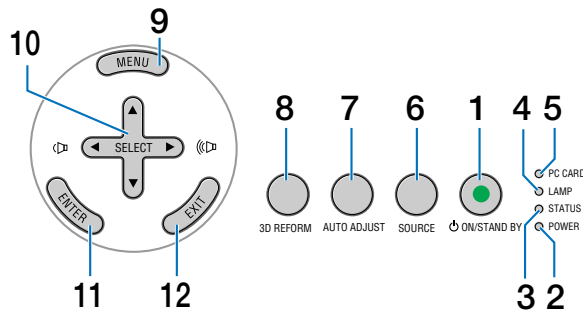

1. POWER Button (ON / STAND BY) (→ page 24, 35)

*NOTE: To turn on the projector, press and hold this button for a minimum of two seconds. To turn off the projector, press this button twice.*

2. POWER Indicator (  $\phi$  ) (→ page 24, 35, 117)

3. STATUS Indicator (→ page 117)

4. LAMP Indicator (→ page 110, 117)

5. PC CARD Access Indicator (→ page 21, 22)

6. SOURCE Button

7. AUTO ADJUST Button (→ page 33)

8. 3D REFORM Button (→ page 31, 41)

9. MENU Button

10. SELECT  $\blacktriangle$  $\blacktriangledown$  $\blacktriangleleft$  $\blacktriangleright$  / Volume Buttons

11. ENTER Button

12. EXIT Button

## Terminal Panel Features

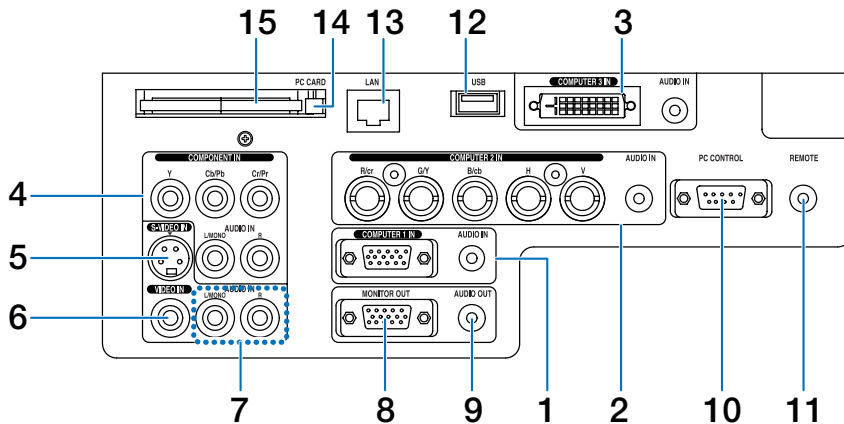

The actual appearance of the terminal panel may differ slightly from that shown in the drawing, but this does not affect the projector's performance.

1. **COMPUTER 1 IN/Component Connector (Mini D-Sub 15 Pin)** (→page 13, 15)  
**AUDIO IN (Stereo Mini Jack)** (→page 13, 14, 16)
2. **COMPUTER 2 IN/Component (R/cr, G/V, B/cb, H, V) Connectors (BNC x 5)** (→page 13)  
**AUDIO IN (Stereo Mini Jack)** (→page 13)
3. **COMPUTER 3 IN Connector (DVI-D 24 Pin) (HDCP compatible)** (→page 14)  
**AUDIO IN (Stereo Mini Jack)** (→page 14)
4. **COMPONENT IN (Y, Cb/Pb, Cr/Pr) Connectors (RCA)** (→page 17)  
**AUDIO L/MONO, R (RCA)** (→page 17)
5. **S-VIDEO IN Connector (Mini DIN 4 Pin)** (→page 18)
6. **VIDEO IN Connector (RCA)** (→page 18)
7. **VIDEO/S-VIDEO AUDIO L/MONO, R (RCA)** (→page 18)
8. **MONITOR OUT Connector (Mini D-Sub 15 Pin)** (→page 16)
9. **AUDIO OUT (Stereo Mini Jack)** (→page 16)
10. **PC CONTROL Port (D-Sub 9 Pin)** (→page 127, 128)  
Use this port to connect your PC or control system to control your projector via a serial cable. This enables you to control the projector using serial communication protocol. A commercially available RS232C cross cable is required to use this port. You can also control the projector by using PC Control Utility 3.0 contained on the supplied User Supportware 3 CD-ROM. To do so you must first have PC Control Utility 3.0 installed on your PC. If you are writing your own program, typical PC control codes are on page 127.
11. **Remote Jack (Stereo Mini Jack)** (→page 11)  
*NOTE: Connecting the remote cable to the REMOTE mini jack on the terminal panel will make the wireless operation unavailable.*
12. **USB Port (Type A)** (→page 38, 59)
13. **LAN Port (RJ-45)** (→page 19, 89)
14. **PC CARD Eject Button** (→page 22)
15. **PC CARD Slot** (→page 21)  
*NOTE: A dummy card is inserted into each slot at the time of shipment. First remove the dummy cards before use.*

## 4 Part Names of the Remote Control

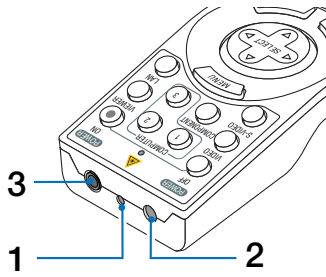

### 1. Laser Pointer



#### CAUTION:

- \* Do not look into the laser pointer while it is on.
- \* Do not point the laser beam at a person.

### 2. Infrared Transmitter

### 3. Remote jack (→ page 11)

### 4. LED

Flashes when any button is pressed.

### 5. POWER ON Button (→ page 24)

*NOTE: To turn on the projector, press and hold the POWER ON button for a minimum of two seconds.*

### 6. POWER OFF Button (→ page 35)

*NOTE: To turn off the projector, press the POWER OFF button twice.*

### 7. COMPUTER 1 Button (→ page 26)

### 8. COMPUTER 2 Button (→ page 26)

### 9. COMPUTER 3 Button (→ page 26)

### 10. VIDEO Button (→ page 26)

### 11. S-VIDEO Button (→ page 26)

### 12. COMPONENT Button (→ page 26)

### 13. VIEWER Button (→ page 26, 58)

### 14. LAN Button (→ page 26)

### 15. MENU Button

### 16. SELECT ▲▼◀▶ Button

### 17. ENTER Button

### 18. EXIT Button

### 19. LASER Button (→ page 34)

### 20. MOUSE R-CLICK Button (→ page 40)

### 21. MOUSE L-CLICK Button (→ page 40)

### 22. FREEZE Button (→ page 36)

### 23. ASPECT Button (→ page 77)

### 24. VOLUME +/- Buttons (→ page 33)

### 25. PICTURE Button (→ page 72, 74)

### 26. PIC-MUTE Button (→ page 36)

### 27. MAGNIFY +/- Buttons (→ page 36)

### 28. LAMP MODE Button (→ page 36)

### 29. AUTO ADJ. Button (→ page 33)

### 30. PAGE UP/DOWN Buttons (→ page 40)

### 31. 3D REFORM Button (→ page 31, 41)

### 32. HELP Button (→ page 37)

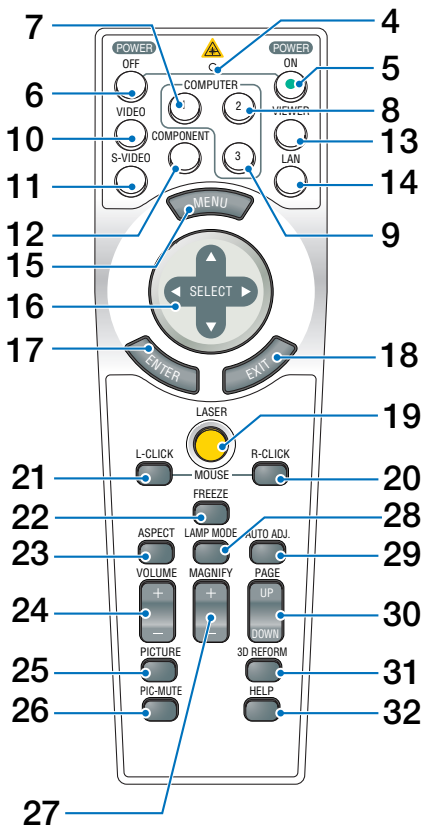

## Battery Installation

**1** Press the catch and remove the battery cover.

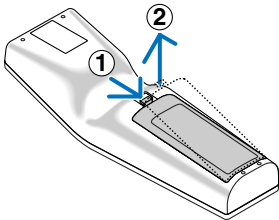

**2** Install new ones (AA). Ensure that you have the batteries' polarity (+/-) aligned correctly.

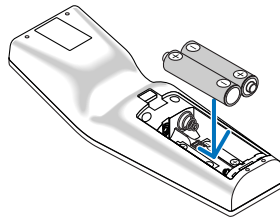

**3** Slip the cover back over the batteries until it snaps into place.

*NOTE: Do not mix different types of batteries or new and old batteries.*

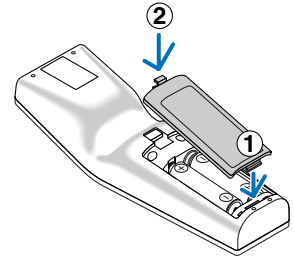

## Operating Range for Wireless Remote Control

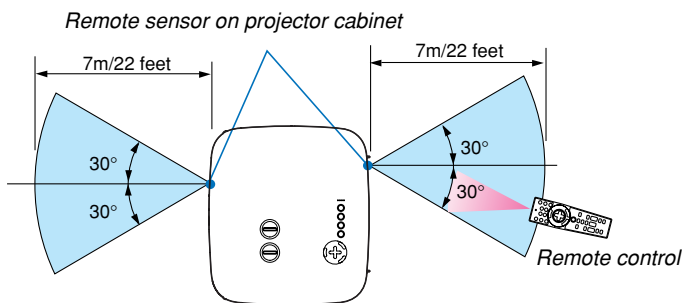

*NOTE: Actual operating range may differ slightly from that shown in the drawing.*

**TIP:** You can determine which remote sensor on the projector is enabled in wireless mode. The options are: front, rear or both. (→ page 96)

- The infrared signal operates by line-of-sight up to a distance of about 22 feet/7 m and within a 60-degree angle of the remote sensor on the projector cabinet.
- The projector will not respond if there are objects between the remote control and the sensor, or if strong light falls on the sensor.
- Weak batteries will also prevent the remote control from properly operating the projector.

## Remote Control Precautions

- Handle the remote control carefully.
- If the remote control gets wet, wipe it dry immediately.
- Avoid excessive heat and humidity.
- Do not heat, take apart, or throw batteries into fire.
- If you will not be using the remote control for a long time, remove the batteries.
- Ensure that you have the batteries' polarity (+/-) aligned correctly.
- Do not use new and old batteries together, or use different types of batteries together.
- Dispose of used batteries according to your local regulations.



### Using the Remote Control in Wired Operation

Connect one end of the supplied remote cable to the REMOTE mini jack and the other end to the remote jack on the remote control.

*NOTE: Connecting the remote cable to the REMOTE mini jack on the terminal panel will make the wireless operation unavailable.*

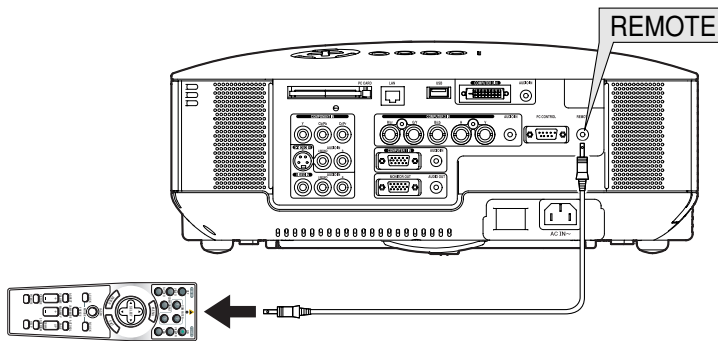

# 2. Installation and Connections

This section describes how to set up your projector and how to connect PCs, video and audio sources.

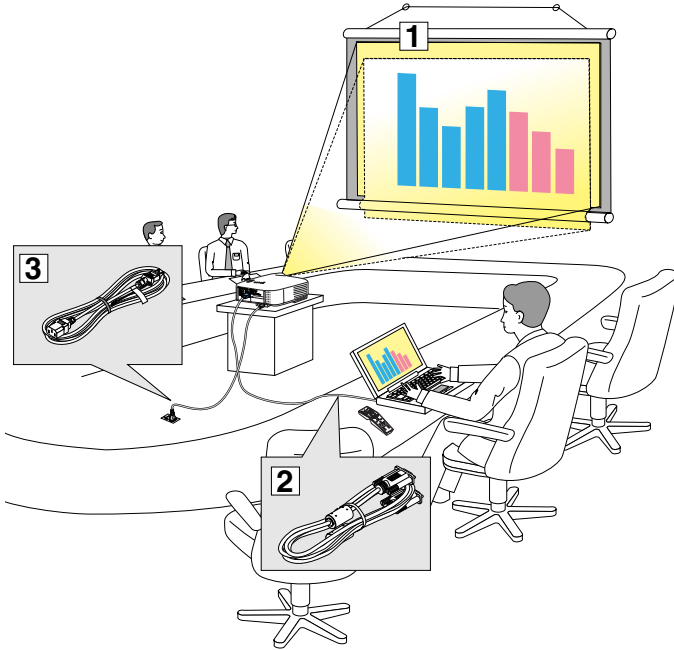

Your projector is simple to set up and use. But before you get started, you must first:

- z Set up a screen and the projector.
- x Connect your computer or video equipment to the projector. See pages 13 - 22.
- c Connect the supplied power cable. See page 23.

**NOTE:** Ensure that the power cable and any other cables are disconnected before moving the projector. When moving the projector or when it is not in use, cover the lens with the lens cap.

## 1 Setting Up the Screen and the Projector

The further your projector is from the screen or wall, the larger the image. The minimum size the image can be is approximately 30 inches (0.76 m) measured diagonally when the projector is roughly 41 inches (1.0 m) from the wall or screen. The largest the image can be is 500 inches (12.7 m) when the projector is about 718 inches (18.2 m) from the wall or screen. Use the drawing below as a guide.

### Selecting a Location

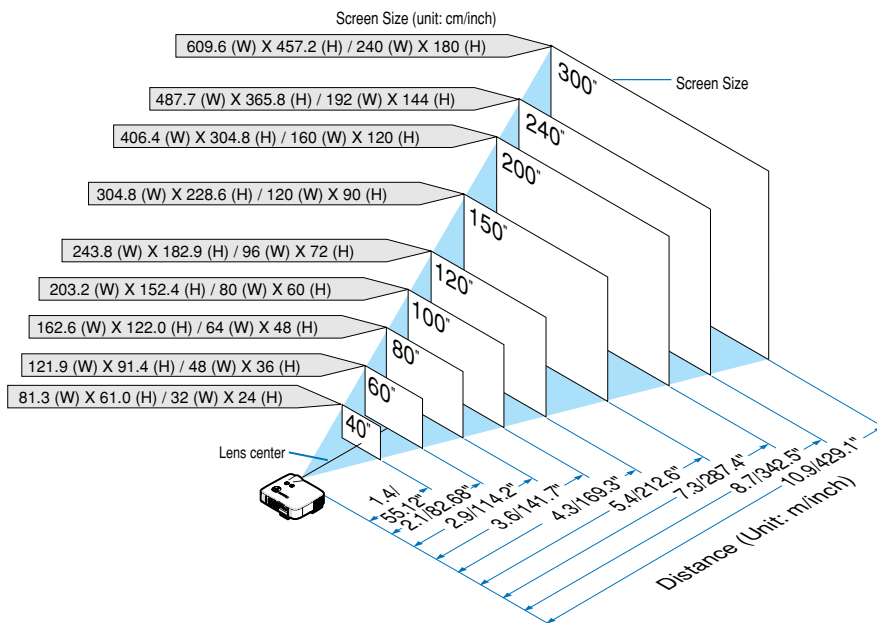

**TIP:** The screen sizes above are intermediate values between tele (minimum display area) and wide (maximum display area) when the standard lens is used. Image size can be adjusted with the zoom adjustment up to a maximum of 15%. For optional lenses, see page 113.

## ② Making Connections

### Connecting Your PC or Macintosh Computer

*NOTE: When using with a notebook PC, be sure to connect the projector and notebook PC while the projector is in standby mode and before turning on the power to the notebook PC.*

*In most cases the output signal from the notebook PC is not turned on unless connected to the projector before being powered up.*

*\* If the screen goes blank while using your remote control, it may be the result of the computer's screen-saver or power management software.*

### Enabling the computer's external display

Displaying an image on the notebook PC's screen does not necessarily mean it outputs a signal to the projector.

When using a PC compatible laptop, a combination of function keys will enable/disable the external display.

Usually, the combination of the 'Fn' key along with one of the 12 function keys gets the external display to come on or off. For example, NEC laptops use Fn + F3, while Dell laptops use Fn + F8 key combinations to toggle through external display selections.

*NOTE: The COMPUTER 1 IN connector supports Plug & Play (DDC2).*

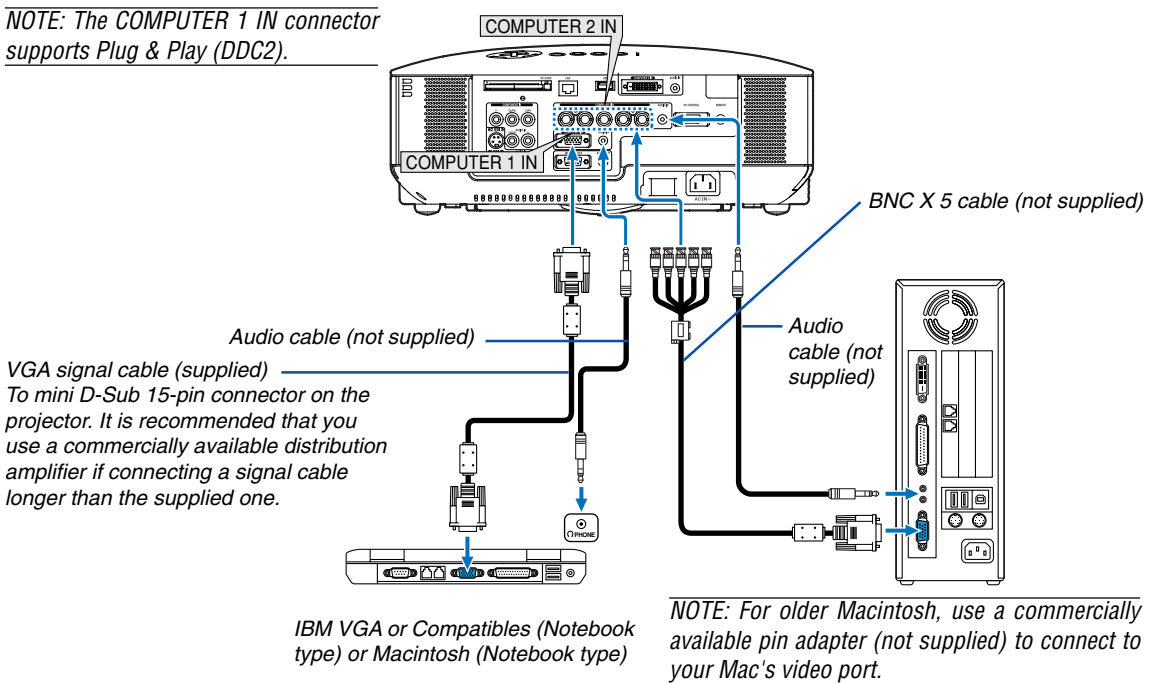

- First turn off the computer and the projector before making connections.
- Turn down the volume on the computer before connecting an audio cable the headphone jack of the computer. After connecting the computer to the projector, you can adjust the sound level on the computer and the projector to your preference.
- You are recommended to connect an audio cable to an audio out connector (mini jack type) if any.

*NOTE: The NP2000/NP1000 is not compatible with video decoded outputs of either the NEC ISS-6020 and ISS-6010 switchers.*

*NOTE: An image may not be displayed correctly when a Video or S-Video source is played back via a commercially available scan converter.*

*This is because the projector will process a video signal as a computer signal at the default setting. In that case, do the following.*

- \* *When an image is displayed with the lower and upper black portion of the screen or a dark image is not displayed correctly:*  
Project an image to fill the screen and then press the AUTO ADJ button on the remote control or the AUTO ADJUST button on the projector cabinet.
- \* *When noise appears on the sides of the screen:*  
Use the Overscan feature to display the image correctly.  
Be sure to change the Overscan to 0% before pressing the AUTO ADJ or AUTO ADJUST button, otherwise an image may be displayed with its sides cut off.

### When Viewing a DVI Digital Signal

To project a DVI digital signal, be sure to connect the PC and the projector using a DVI-D signal cable (not supplied) before turning on your PC or projector. Turn on the projector first and select DVI (DIGITAL) from the source menu before turning on your PC.

Failure to do so may not activate the digital output of the graphics card resulting in no picture being displayed. Should this happen, restart your PC.

Do not disconnect the DVI-D signal cable while the projector is running. If the signal cable has been disconnected and then re-connected, an image may not be correctly displayed. Should this happen, restart your PC.

#### NOTE:

- Use a DVI-D cable compliant with DDWG (Digital Display Working Group) DVI (Digital Visual Interface) revision 1.0 standard. The DVI-D cable should be within 10 m (394") long.
- The DVI (DIGITAL) connector (COMPUTER 3) accepts VGA (640x480), SVGA (800x600), 1152x864, XGA (1024x768), SXGA (1280x1024 @ up to 60Hz) and SXGA+ (1400x1050 @ up to 60Hz).

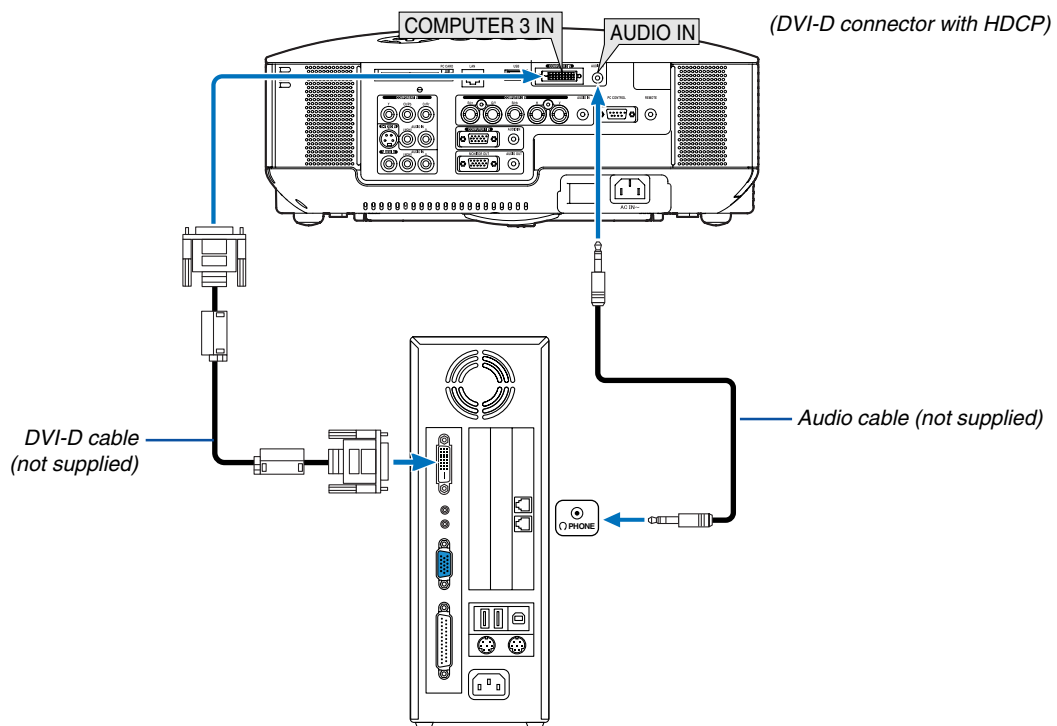

IBM VGA or Compatibles or Macintosh

### What is HDCP/HDCP technology?

HDCP is an acronym for High-bandwidth Digital Content Protection. High bandwidth Digital Content Protection (HDCP) is a system for preventing illegal copying of video data sent over a Digital Visual Interface (DVI).

If you are unable to view material via the DVI input, this does not necessarily mean the projector is not functioning properly. With the implementation of HDCP, there may be cases in which certain content is protected with HDCP and might not be displayed due to the decision/intention of the HDCP community (Digital Content Protection, LLC).

### To connect SCART output (RGB)

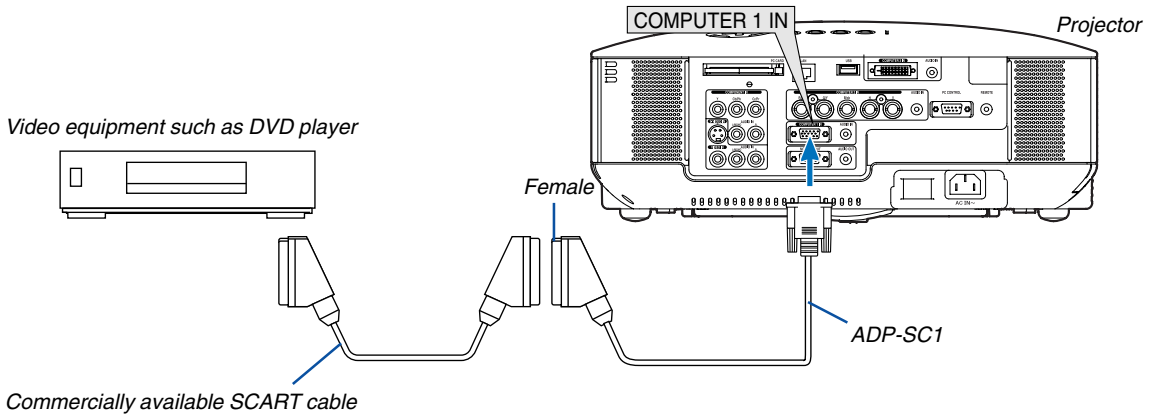

Before connections: An exclusive SCART adapter (ADP-SC1) and a commercially available SCART cable are required for this connection.

From the menu, select [Setup] → [Options] → [Signal Select] → [Computer 1] → [Scart].

SCART is a standard European audio-visual connector for TVs, VCRs and DVD players. It is also referred to as Euro-connector.

---

*NOTE: Audio signal is not available for this connection.*

---

**TIP:** The ADP-SC1 SCART adapter is obtainable from your NEC dealer in Europe. Contact your NEC dealer in Europe for more information.

### Connecting an External Monitor

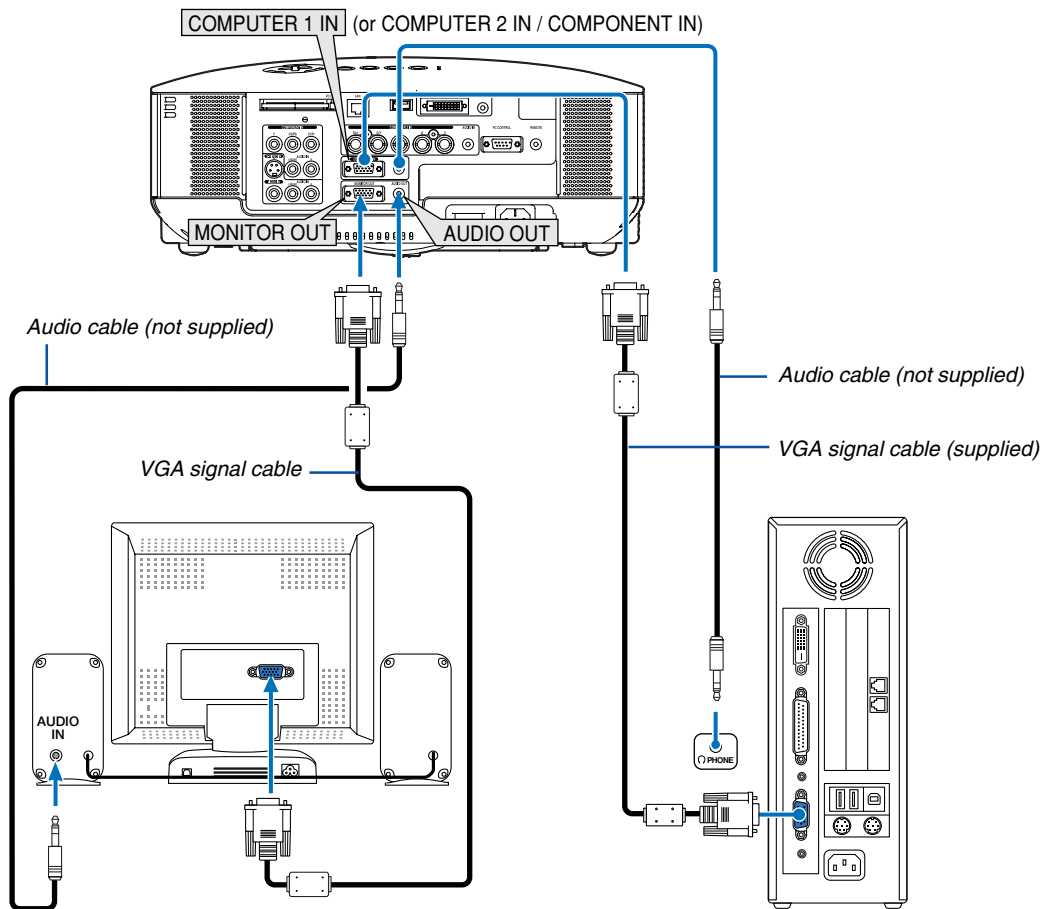

You can connect a separate, external monitor to your projector to simultaneously view on a monitor the RGB analog or component image you're projecting.

**NOTE:**

- *Daisy chain connection is not possible.*
- *The MONITOR OUT connector will output no video signal (Digital signal) from the COMPUTER 3 IN connector.*
- *When audio equipment is connected, the projector speaker is disabled.*

### Connecting Your DVD Player with Component Output

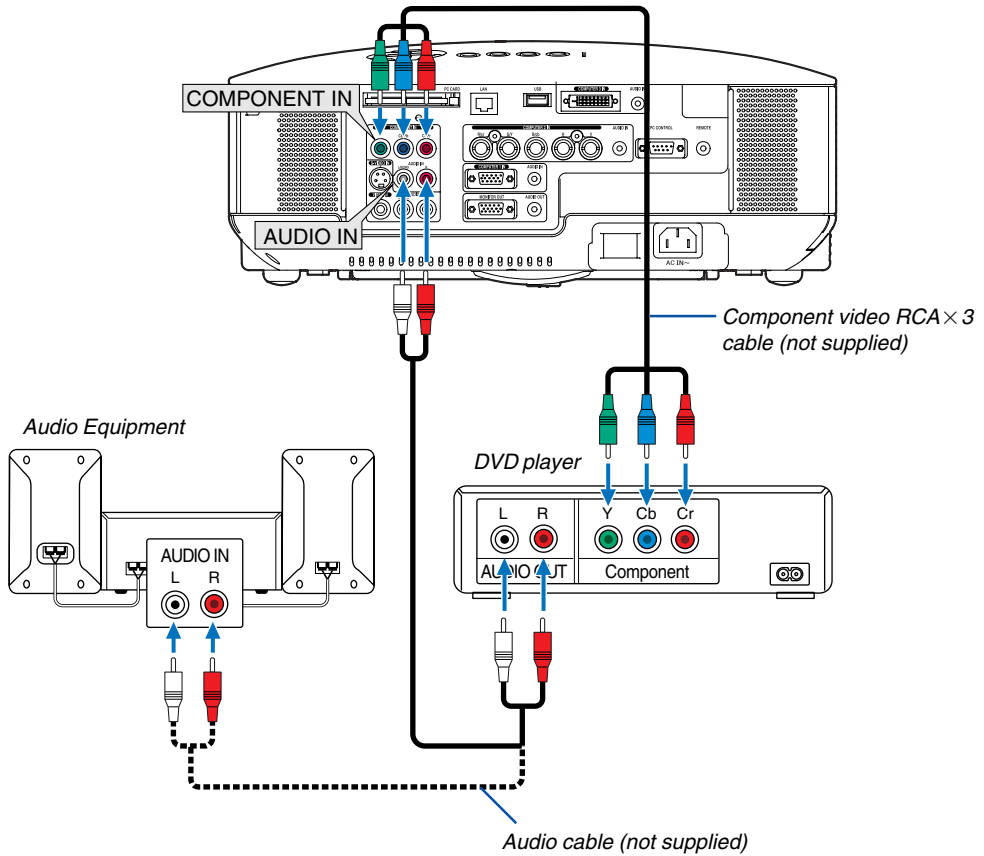

**TIP:** A component signal will be automatically displayed. If not, from the menu, select [Setup] → [Options] → [Signal Select] → [Computer 1 (or 2)] → [Component].

- When connecting to the COMPUTER 2 IN, use a commercially available RCA (female)-to-BNC(male) adapter.

**NOTE:** Refer to your DVD player's owner's manual for more information about your DVD player's video output requirements.

### Connecting Your VCR or Laser Disc Player

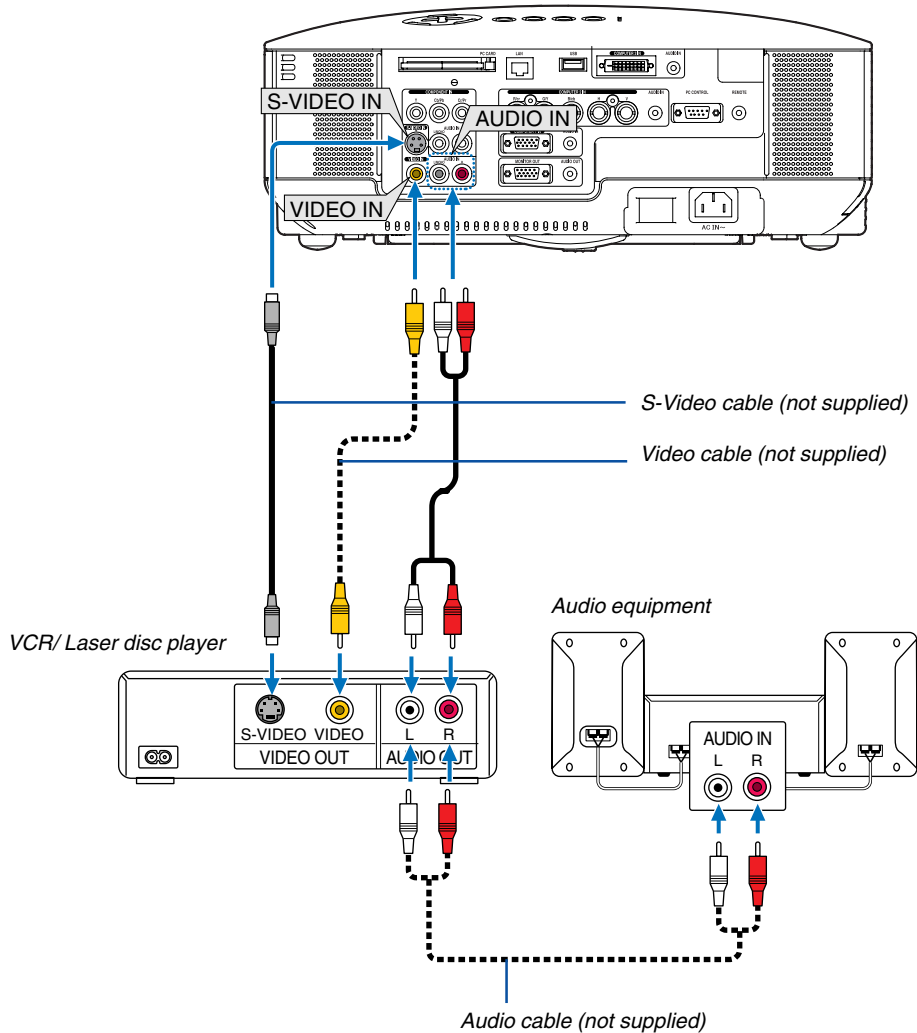

**TIP:** You can connect a video cable to the "Y" connector of the COMPONENT connectors to display a VCR source. To do so, from the menu, select [Setup] → [Options] → [Signal Select] → [Component] → [Video].

**NOTE:** Refer to your VCR or laser disc player owner's manual for more information about your equipment's video output requirements.

**NOTE:** An image may not be displayed correctly when a Video or S-Video source is played back in fast-forward or fast-rewind via a scan converter.



### Connecting to a Network

The NP2000/NP1000 comes standard with a LAN port (RJ-45) which provides a LAN connection using a LAN cable. Placing the optional wireless LAN card (NWL-100\*) in the PC card slot of the projector also provides a wireless LAN connection. To use a LAN connection, you are required to assign an IP address to the projector. For setting the LAN mode, see page 89 (From the menu, select [Setup] → [Installation] → [LAN Mode])

With the LAN connection, two features are available: Projector control and Picture transmission.

### Projector control feature

With the wired or wireless LAN connection, you can control (power on/off, input select, etc.) and receive information from the projector over the network using a computer. The following two methods are available:

- \* Using the HTTP Server feature on the projector. (→ page 51)
- \* Using PC Control Utility 3.0 from the supplied User Supportware 3 CD-ROM.

### Picture transmission feature

With the wired or wireless LAN connection, you can send images and slides from a personal computer to the projector which then can be projected on the screen. The following two methods are available:

- \* Using Image Express Utility 2.0 from the supplied User Supportware 3 CD-ROM.
- \* Using Ulead Photo Explorer 8.0 from the supplied User Supportware 3 CD-ROM.

With the USB mouse connected to the projector, you can also operate the desktop screen on your Windows PC connected to the LAN or the wireless LAN.

- \* Using Desktop Control Utility 1.0 from the supplied User Supportware 3 CD-ROM.

---

*NOTE: Use a wireless LAN card conforming to the Wi-Fi standard for your personal computer.*

---

**TIP:** Five Windows software programs (Image Express Utility 2.0, Desktop Control Utility 1.0, Ulead Photo Explorer 8.0, Viewer PPT Converter and PC Control Utility 3.0) and a Macintosh software program (Image Express Utility 2 for Mac OS X) are contained on the supplied Projector User Supportware 3 CD-ROM. For their functions and operations, see the user's guides (PDF) contained on the same CD-ROM.

### Example of LAN connection

(A) Example of wired LAN connection

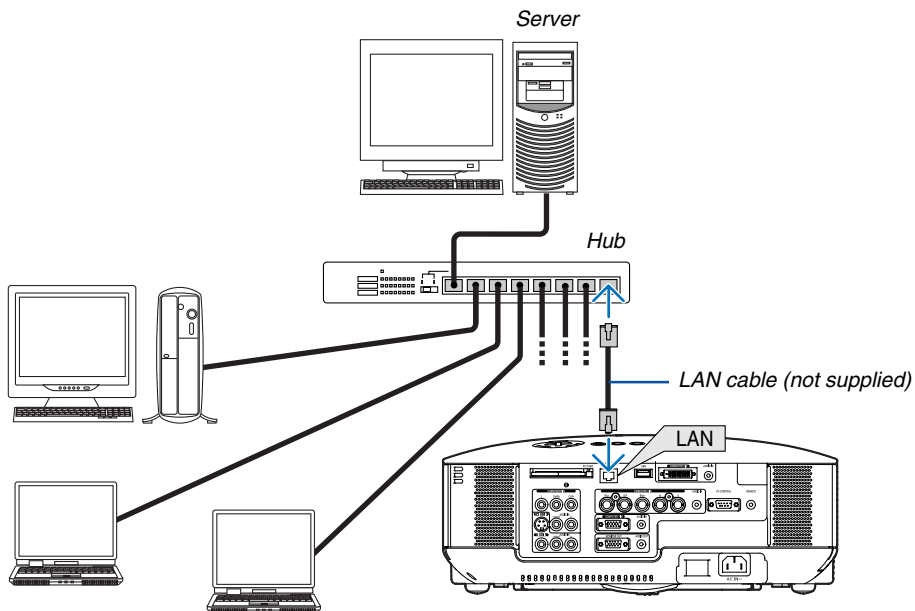

(B) Example of wireless LAN connection  
(Network Type → Mode: Infrastructure)

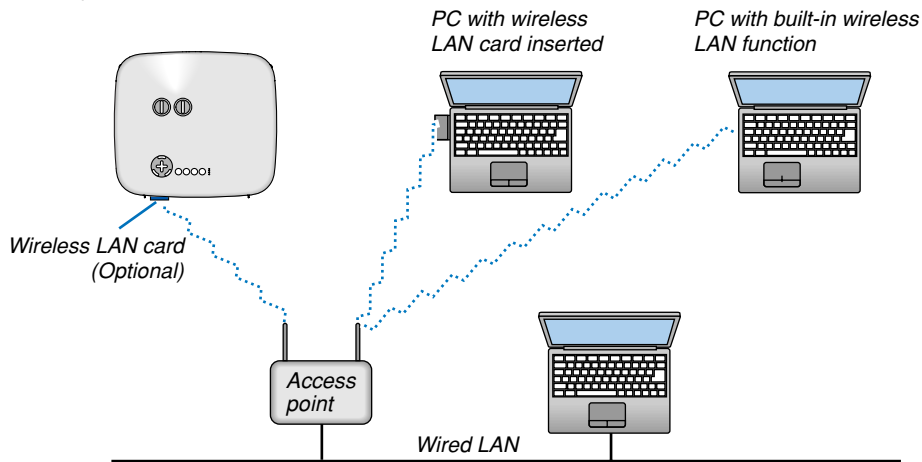

To make connection with a wired LAN via an access point, you need to select the Infrastructure mode. From the menu, select [Setup] → [Installation] → [LAN Mode] → [PC Card] → [Advanced] → [Network Type] → [Mode] → [Infrastructure].

(C) Example of wireless LAN connection (Network Type → Mode: 802.11 Ad Hoc)

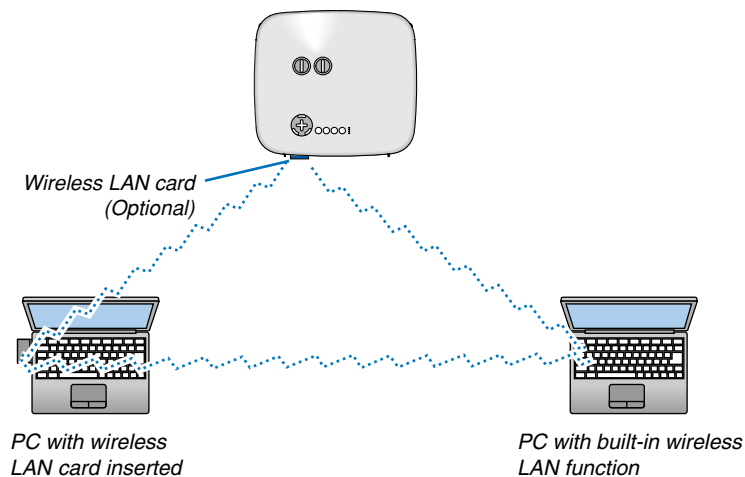

To enable direct communication (i.e., peer-to-peer) between personal computers and projectors, you need to select the 802.11 Ad Hoc mode.

From the menu, select [Setup] → [Installation] → [LAN Mode] → [PC Card] → [Advanced] → [Network Type] → [Mode] → [802.11 Ad Hoc].

The 802.11 Ad Hoc mode complies with IEEE802.11 standard.

When in Ad Hoc mode, only 802.11b is available for communication method. Data transmission speed in Ad Hoc mode is limited up to 11Mbps.

### Inserting and Removing a PC Card

To insert the NEC optional wireless LAN card or a PC memory card (also referred to as PC card in this manual), follow the steps below.

#### CAUTION:

- \* **Direction for Inserting the PC Card**  
The PC card has a top and bottom and must be inserted into the PC card slot in a specific direction. It cannot be inserted backwards or upside-down.  
Attempting to force it into the slot in the wrong direction may break the internal pin and damage the card slot. Refer to the PC card's operating instructions for the proper direction of insertion.
- \* **Back up your PC card's data in case it will need to be restored.**
- \* **To prevent electrostatic discharge damage to the wireless LAN card, wear an anti-static wrist strap. If no wrist strap is available, ground yourself by touching metal such as a door knob.**
- \* **Always insert or remove the wireless LAN card when the main power is turned off. Failure to do so may cause projector malfunction or damage to the wireless LAN card. If the projector will not work correctly, turn off the projector, wait 30 seconds, and turn it back on.**

A dummy card is inserted into the PC CARD slot at the time of shipment. First remove the dummy cards before use.

### Inserting the PC Card

- 1. Make sure the main power is off before inserting the PC card. (This step is needed only when the wireless LAN card being inserted into the projector's PC CARD slot)**
- 2. Hold the PC card horizontally and insert it slowly into the PC card slot with its top facing up.**

The eject button pops out once the PC card is fully inserted. Check that the PC card is fully inserted.

*NOTE: Do not try to force the PC card into the slot or you may bend the pins inside the slot.*

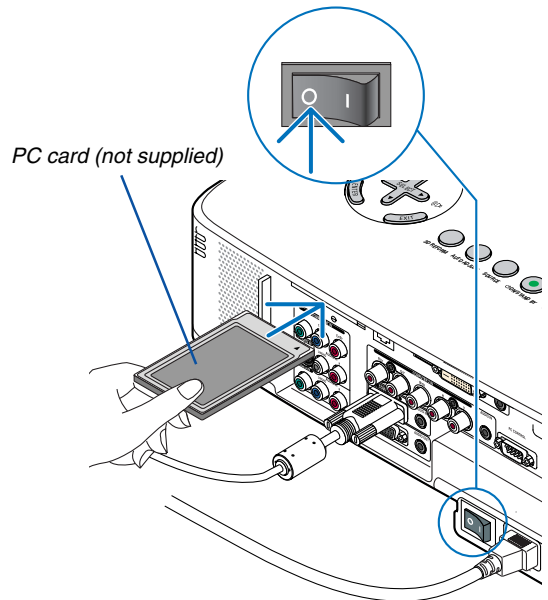

## 2. Installation and Connections

### Removing the PC Card

1. Make sure that the PC CARD access indicator is not lit. (This step is needed only when the PC memory card being inserted into the projector's PC CARD slot.)

*NOTE: The PC CARD access indicator lights while its data is being accessed.*

2. To remove the wireless LAN card, make sure that the main power is off. (This step is needed only when the wireless LAN card being inserted into the projector's PC CARD slot)
3. Press the eject button slowly. The eject button pops out a little.
4. Press the eject button slowly again.
5. Grasp the edges of the PC card and pull it out.

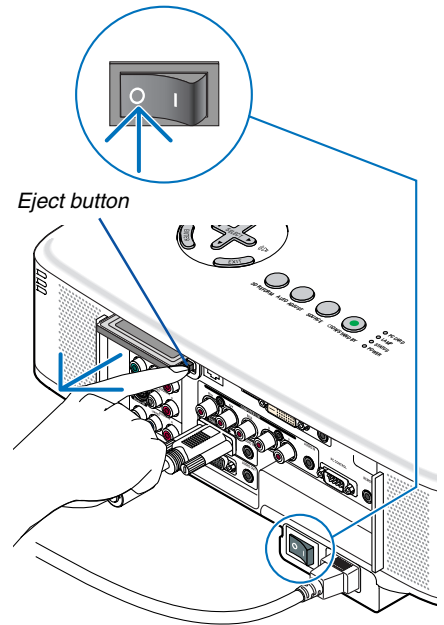

### PC Card Lock

The supplied PC card lock prevents a PC card or an optional wireless LAN card from being ejected during use. The screw for the PC card lock is mounted under the PC card slot on the rear side of the projector. To attach the PC card lock to the projector, first remove the screw and use it.

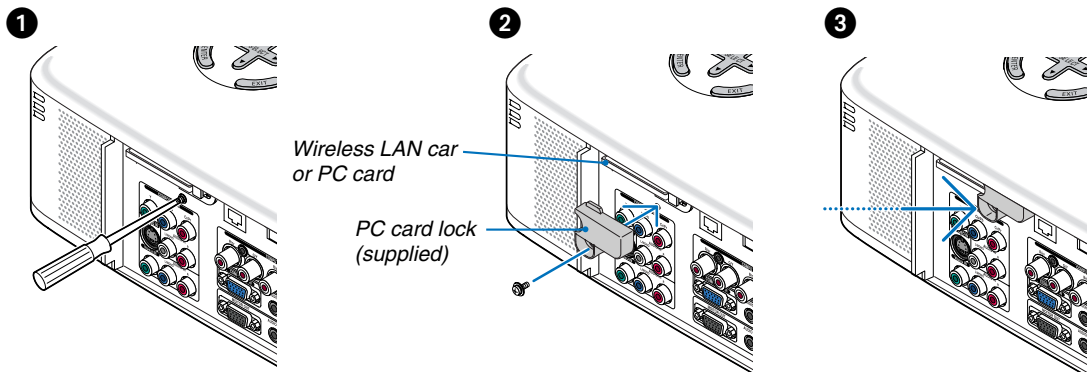

*NOTE: Some PC cards cannot be used based on their size and shape.*

### PC Card Type

The PC Card slot accepts PCMCIA Type II only.

*NOTE: The projector does not support NTFS formatted flash memory card or USB memory device.*

*Be sure to use a flash memory card or USB memory device formatted with the FAT32, FAT16 or FAT file system.*

*To format your flash memory card or USB memory device in your computer, refer to the document or help file that comes with your Windows operating systems.*

### Connecting the Supplied Power Cable

Connect the supplied power cable to the projector.

First connect the supplied power cable's three-pin plug to the AC IN of the projector, and then connect the other plug of the supplied power cable in the wall outlet.

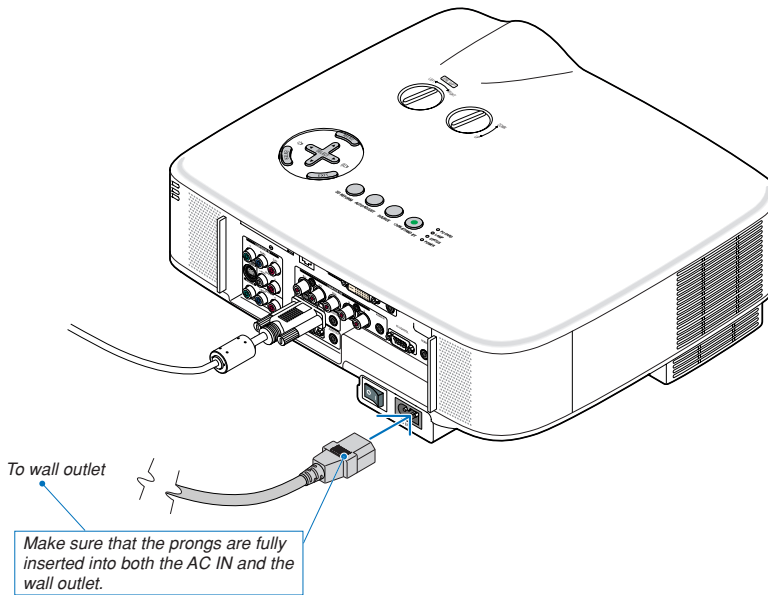

### About Direct Power Off

The projector has a feature called "Direct Power Off". This feature allows the projector to be turned off (even when projecting an image) using a power strip equipped with a switch and a breaker.

*NOTE: Before using Direct Power Off, be sure to allow at least 20 minutes immediately after turning on the projector and starting to display an image.*

#### **⚠ CAUTION:**

Do not try to touch the ventilation outlet on the left front (when seen from the front) as it can become heated while the projector is turned on and immediately after the projector is turned off.

#### **⚠ CAUTION:**

Do not unplug the power cable from the wall outlet or projector when the project is powered on. Doing so can cause damage to the AC IN connector of the projector and (or) the prong plug of the power cable.

*TIP: To turn off the AC power supply when the projector is powered on, use a power strip equipped with a switch and a breaker.*

*TIP: The projector can be unplugged during its cool down period after it is turned off.*

# 3. Projecting an Image (Basic Operation)

This section describes how to turn on the projector and to project a picture onto the screen.

## 1 Turning on the Projector

### NOTE:

- The projector has two power switches: a main power switch and a POWER (ON/STAND BY) button (POWER ON and OFF on the remote control).
- When plugging in or unplugging the supplied power cable, make sure that the main power switch is pushed to the off (O) position. Failure to do so may cause damage to the projector.
- The projector has a feature to prevent itself from being used by unauthorized individuals. To use this feature, register a keyword. (→ page 45)

### 1. Remove the lens cap.

- Do not try to remove the lens cap by pulling on the string. Doing so can cause damage.

### 2. To turn on the main power to the projector, press the Main Power switch to the on position (I).

- The projector will go into standby mode. When in standby mode, the POWER indicator will light orange and the STATUS indicator will light green.

### 3. After making sure that the projector is in standby mode, press the POWER (ON/STAND BY) or POWER (ON) button for a minimum of 2 seconds when the STATUS indicator goes off and the POWER indicator starts blinking.

When the POWER indicator turns a steady green, and the projector is ready to use.

- After you turn on your projector, ensure that the computer or video source is turned on and that your lens cap is removed.

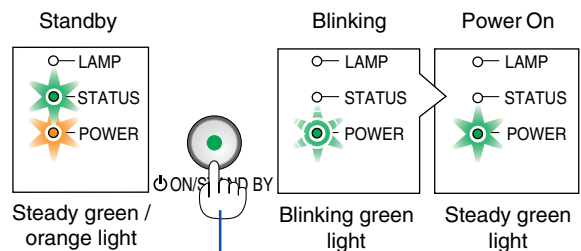
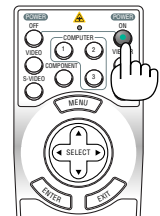
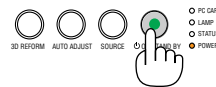
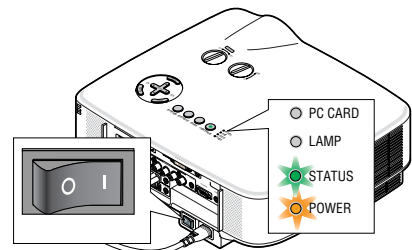

Press this button for a minimum of 2 seconds.

(→ page 117)

NOTE: When no signal is available, a blue, black or logo screen is displayed.

### 3. Projecting an Image (Basic Operation)

#### Note on Startup screen (Menu Language Select screen)

When you first turn on the projector, you will get the Startup menu. This menu gives you the opportunity to select one of the 21 menu languages.

To select a menu language, follow these steps:

1. Use the **SELECT** ▼ button to select one of the 21 languages for the menu.

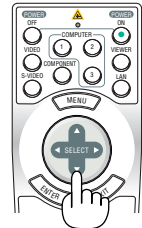
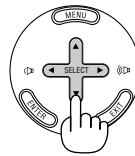
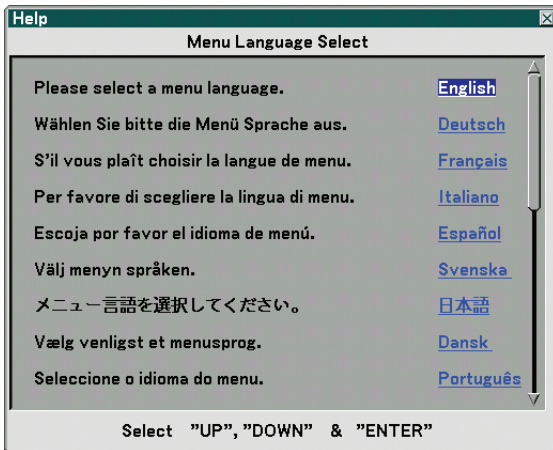

2. Press the **ENTER** button to execute the selection.

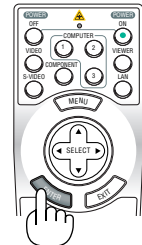
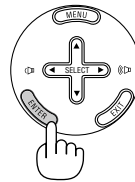

3. To close the menu, press the **EXIT** button.

After this has been done, you can proceed to the menu operation.

If you want, you can select the menu language later. (→ [Language] on page 81)

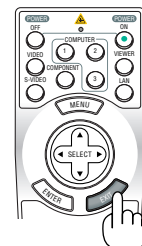
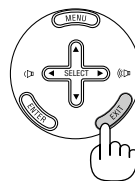

#### NOTE:

- The projector cannot be turned off for 60 seconds after the lamp is turned on and while the POWER indicator is blinking green.
- If you turn on the projector immediately after the lamp is turned off or when the ambient temperature is high, the cooling fans will run for a moment and then you will get an image on the screen.
- Immediately after turning on the projector, screen flicker may occur. This is normal. Wait 3 to 5 minutes until the lamp lighting is stabilized.

- When the Lamp mode is set to Eco, the Lamp indicator will light green.
- If one of the following things happens, the projector will not turn on.
  - If the internal temperature of the projector is too high, the projector detects abnormal high temperature. In this condition the projector will not turn on to protect the internal system. If this happens, wait for the projector's internal components to cool down.
  - When the lamp reaches its end of usable life, the projector will not turn on. If this happens, replace the lamp. (→ page 110)
  - If the lamp fails to light, and if the STATUS indicator flashes on and off in a cycle of six times, wait a full minute and then turn on the power.

## 2 Selecting a Source

### Selecting the computer or video source

#### Selecting from Source List

Press and quickly release the SOURCE button on the projector cabinet to display the Source list. Each time the SOURCE button is pressed, the input source will change as follows: "Computer 1/2/3", "Component", "Video" (VCR or laser disc player), "S-Video", "Viewer" (slides on a PC card) or "LAN" (LAN port [RJ-45] or wireless LAN card).

To display the selected source, press the ENTER button.

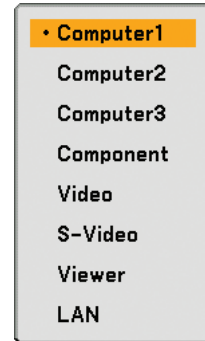
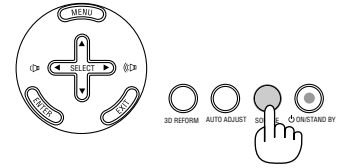

#### Detecting the Signal Automatically

Press and hold the SOURCE button for a minimum of 1 second, the projector will search for the next available input source. Each time you press and hold the SOURCE button for a minimum of 1 second, the input source will change as follows:

Computer1 → Computer2 → Computer3 → Component → Video → S-Video → Viewer → Computer1 → ...

If no input signal is present, the input will be skipped. When the input source you wish to project is displayed, release the button.

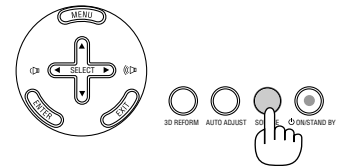

#### Using the Remote Control

Press any one of the COMPUTER 1/2/3, COMPONENT, VIDEO, S-VIDEO, VIEWER or LAN buttons.

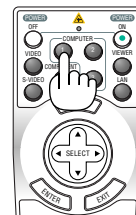



## ③ Adjusting the Picture Size and Position

Use the lens shift dials, the adjustable tilt foot levers, the zoom lever or the focus ring to adjust the picture size and position.

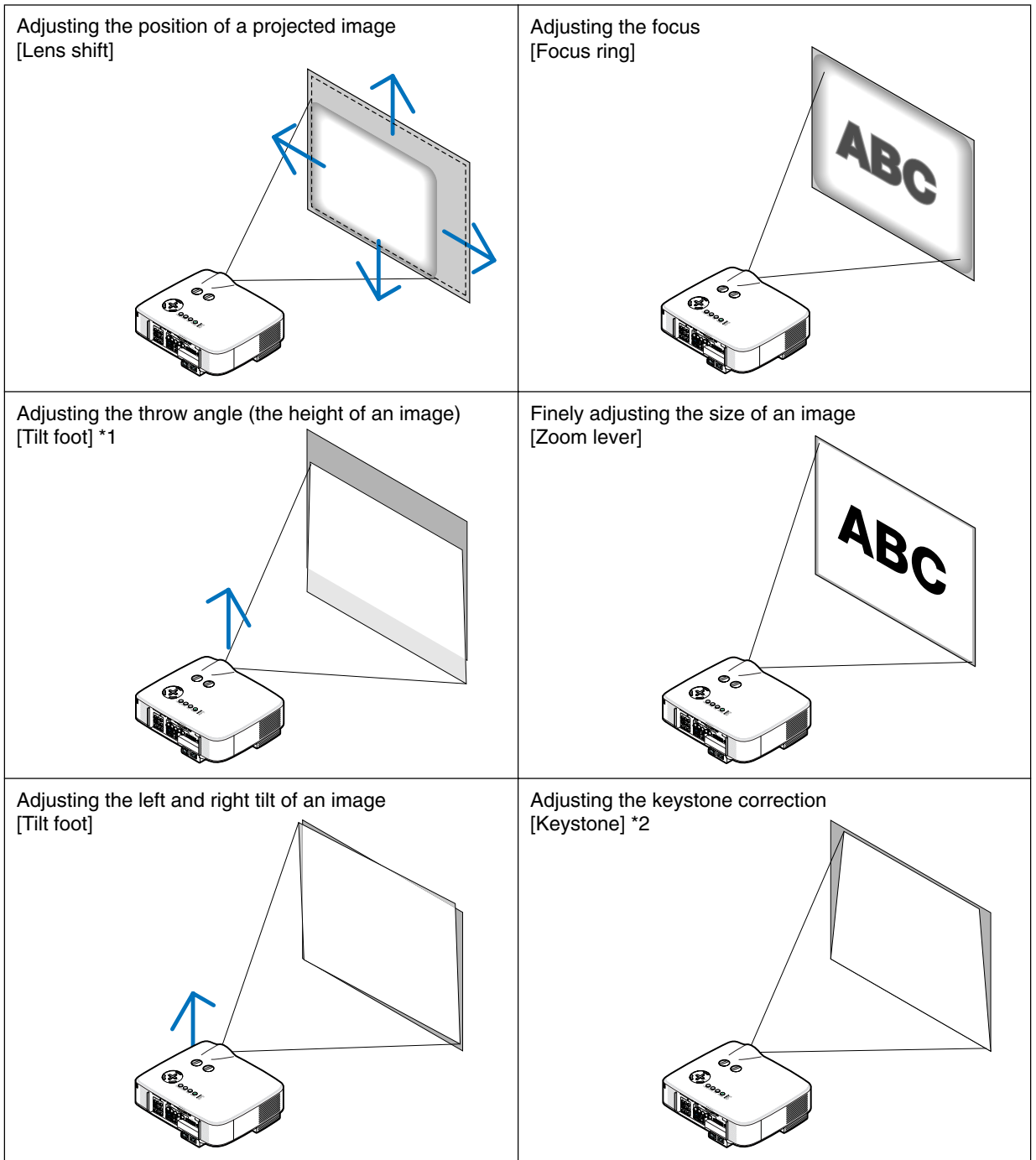

*NOTE\*1: Adjust the throw angle (the height of an image) when the image position is higher than the lens shift adjustable range.*

*NOTE\*2: See "④ Correcting Keystone Distortion" on page 31 for Keystone.*

*\* In the above drawings, cables are omitted for clarity.*

### 3. Projecting an Image (Basic Operation)

#### Adjusting the position of a projected image

- Rotate the lens shift dial.

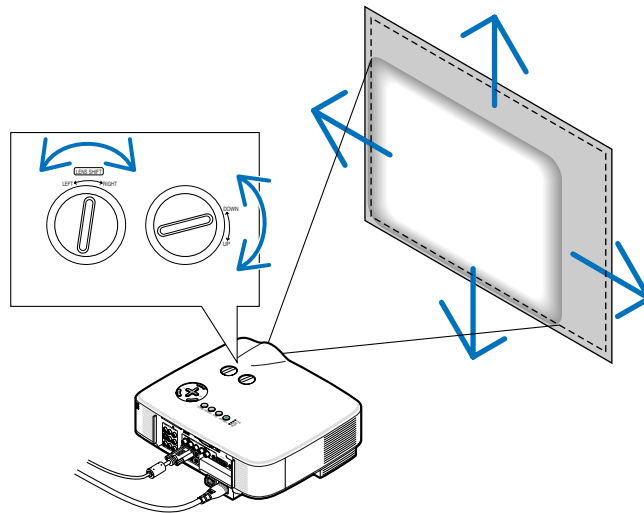

**NOTE:** The lens shift dial for LEFT-RIGHT cannot be rotated one-half turn or more. Do not over rotate it or it may break.

**TIP:** The lens shift dial for UP-DOWN can be rotated one turn or more, but not beyond the adjustable range defined below.

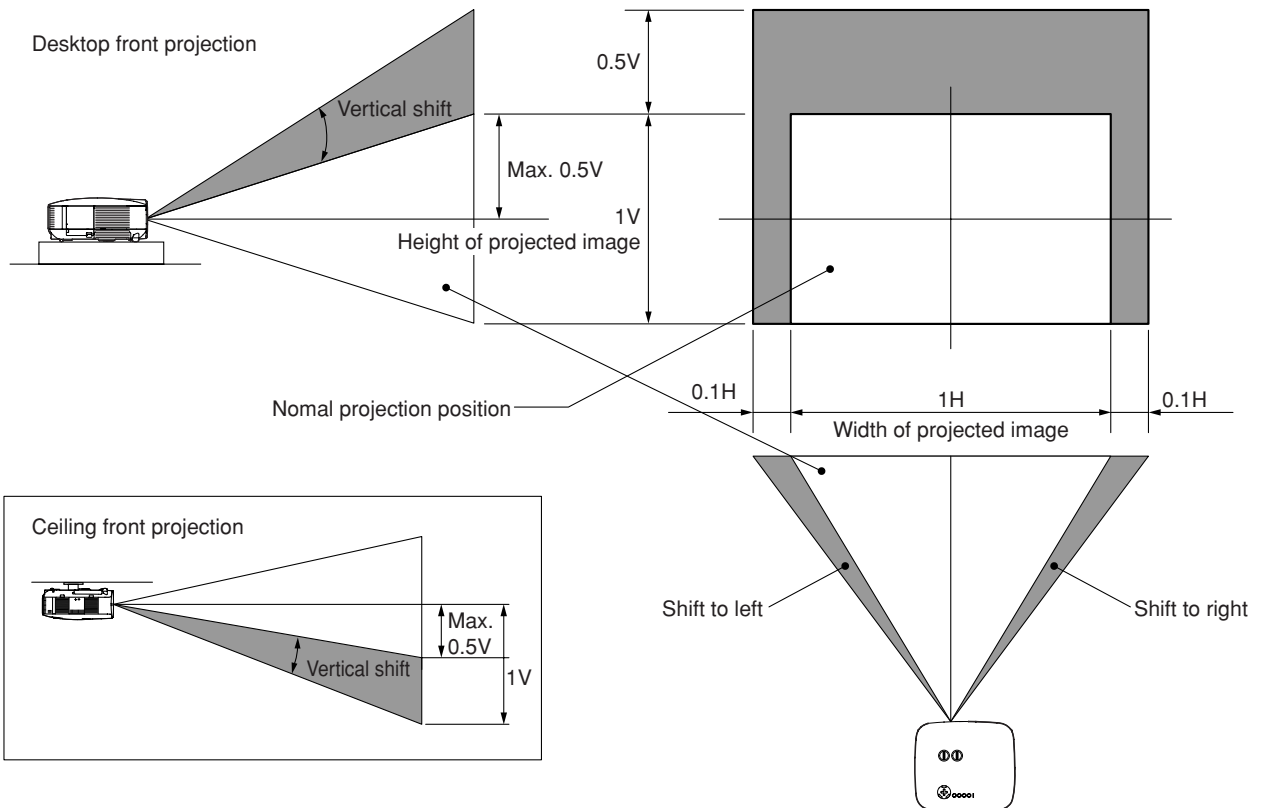

### 3. Projecting an Image (Basic Operation)

#### Adjusting the focus (Focus ring)

- Rotate the focus ring to make focus adjustment.

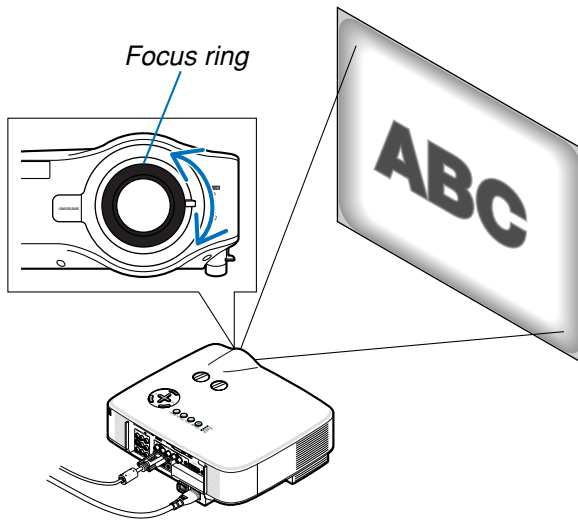

#### Finely adjusting the size of an image (Zoom lever)

- Rotate the zoom lever to adjust the image size on the screen.

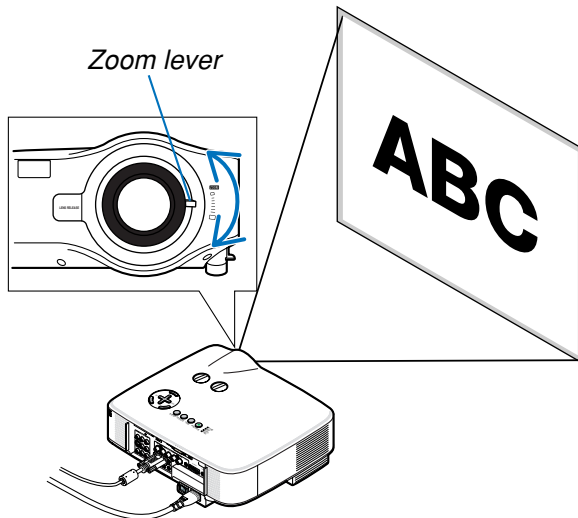

### 3. Projecting an Image (Basic Operation)

#### Adjusting the Tilt Foot

1. Lift the front edge of the projector.

**⚠ CAUTION:**

Do not try to touch the ventilation outlet during Tilt Foot adjustment as it can become heated while the projector is turned on and during its cool down period after it is turned off.

2. Push up the Adjustable Tilt Foot Levers on the right and left sides of the projector to extend the adjustable tilt feet (maximum height).

3. Lower the front of the projector to the desired height.

4. Release the Adjustable Tilt Foot lever to lock the Adjustable tilt foot.

There is approximately 10 degrees (up) of adjustment for the front of the projector.

**TIP:** For operating the [Keystone] screen, see "4 Correcting Keystone Distortion" on page 31.

**NOTE:** Your "Keystone" correction data can be reset by pressing and holding the 3D REFORM button for a minimum of 2 seconds.

**⚠ CAUTION:**

Do not use the tilt-foot for purposes other than originally intended. Misuses such as using the tilt foot to carry or hang (from the wall or ceiling) the projector can cause damage to the projector.

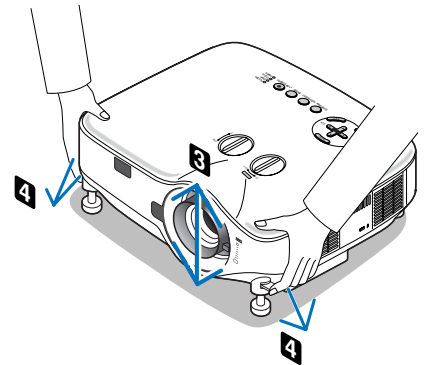
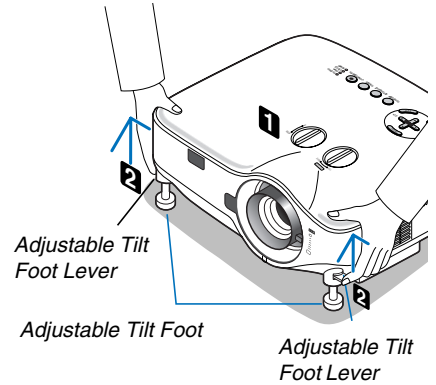

#### 4 Correcting Keystone Distortion

When the projector is not exactly perpendicular to the screen, keystone distortion occurs. To overcome it, you can use the "Keystone" function, a digital technology that can adjust for keystone-type distortion, resulting in a crisp, square image. The following procedure explains how to use the [Keystone] screen from the menu to correct trapezoidal distortions.

When the projector is placed diagonally to the screen,

When the projector is set up at an angle in relation to the screen, adjust the Horizontal option of the Keystone menu so that the top and bottom of sides of the projected image are parallel.



1. Press the 3D REFORM button on the remote control or the projector cabinet.

The Keystone screen will be displayed on the screen.

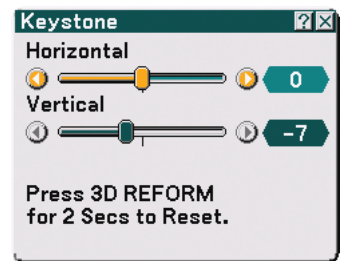

2. Press the SELECT ▼ button to select [Vertical] and then use the SELECT ◀ or ▶ so that the left and right sides of the projected image are parallel.

\* Adjust the vertical keystone distortion.

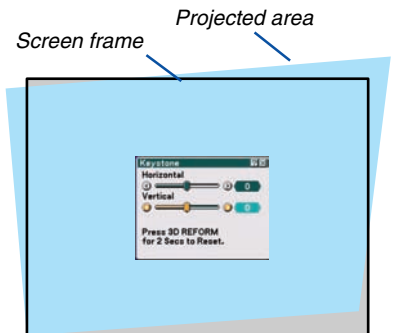

3. Align the left (or right) side of the screen with the left (or right) side of the projected image.

- Use the shorter side of the projected image as the base.
- In the right example, use the left side as the base.

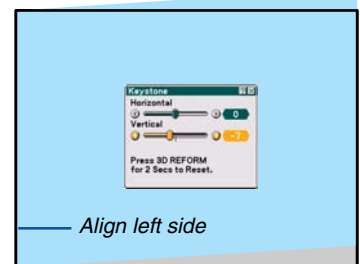

4. Press the SELECT ▲ button to select [Horizontal] and then use the SELECT ◀ or ▶ so that the top and bottom sides of the projected image are parallel.

- Adjust the horizontal keystone distortion.

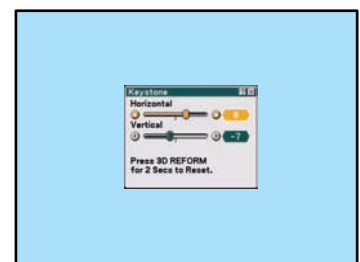

### 3. Projecting an Image (Basic Operation)

5. Repeat steps 2 and 4 to correct keystone distortion.

6. After completing Keystone correction, press the ENTER button.

The Keystone screen will disappear.

- To perform Keystone correction again, press the 3D REFORM button to display the Keystone screen and repeat above steps 1 to 6.



---

#### NOTE:

- If the projection angle is the same as in the last use, the previous correction setting values are retained in the memory.
- When doing Step 2, adjust the position of image so that the screen is smaller than the area of the projected area.
- To reset the 3D Reform correction setting values, press and hold the 3D REFORM button for a minimum of 2 seconds.
- Each time the 3D REFORM button is pressed, the item will change as follows: Keystone → Cornerstone → None → Keystone → ...

For information on [Cornerstone], see "Correcting Horizontal and Vertical Keystone Distortion (Cornerstone) on page 41.

- The Cornerstone adjustment will not be available during the Keystone adjustment. To perform the Cornerstone adjustment, press and hold the 3D REFORM button for a minimum of 2 seconds to reset the Keystone correction setting values. The Keystone adjustment will not be available during the Cornerstone adjustment. To perform the Keystone adjustment, press and hold the 3D REFORM button for a minimum of 2 seconds to reset the Cornerstone correction setting values.
  - The 3D Reform feature can cause an image to be slightly blurred because the correction is made electronically.
-

## 5 Optimizing an RGB Image Automatically

### Adjusting the Image Using Auto Adjust

Optimizing an RGB image automatically.

Press the Auto Adjust button to optimize an RGB image automatically.

This adjustment may be necessary when you connect your computer for the first time.

[Poor picture]

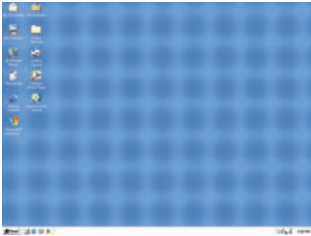

[Normal picture]

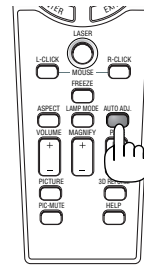
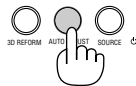
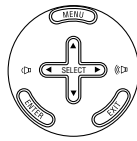
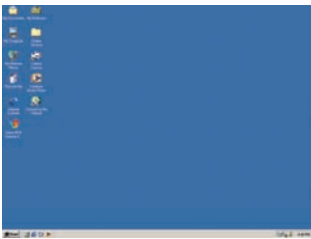

#### NOTE:

- Some signals may take time to display or may not be displayed correctly.
- The Auto Adjust function does not work for component, video signals.
- If the Auto Adjust operation cannot optimize the RGB signal, try to adjust Clock and Phase manually. (→ page 75)

## 6 Adjusting Volume Up & Down

Sound level from the speaker and the AUDIO OUT jack (Stereo mini) on the projector can be adjusted.

#### NOTE:

- Volume control is not available with the SELECT ◀ or ▶ button when an image is enlarged by using the MAGNIFY (+) button or when the menu is displayed.
- The sound level is set to 20 at the factory.

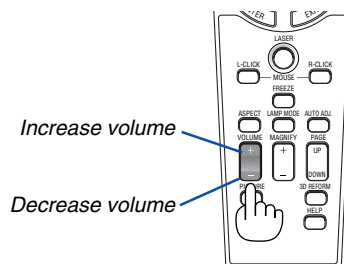
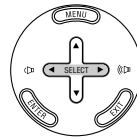

## 7 Using the Laser Pointer

You can use the laser to draw your audience's attention to a red dot that you can place on any object.



#### CAUTION:

- Do not look into the laser pointer while it is on.
- Do not point the laser beam at a person.
- Do not allow children to use the laser pointer.

Press and hold the LASER button to activate the laser pointer.

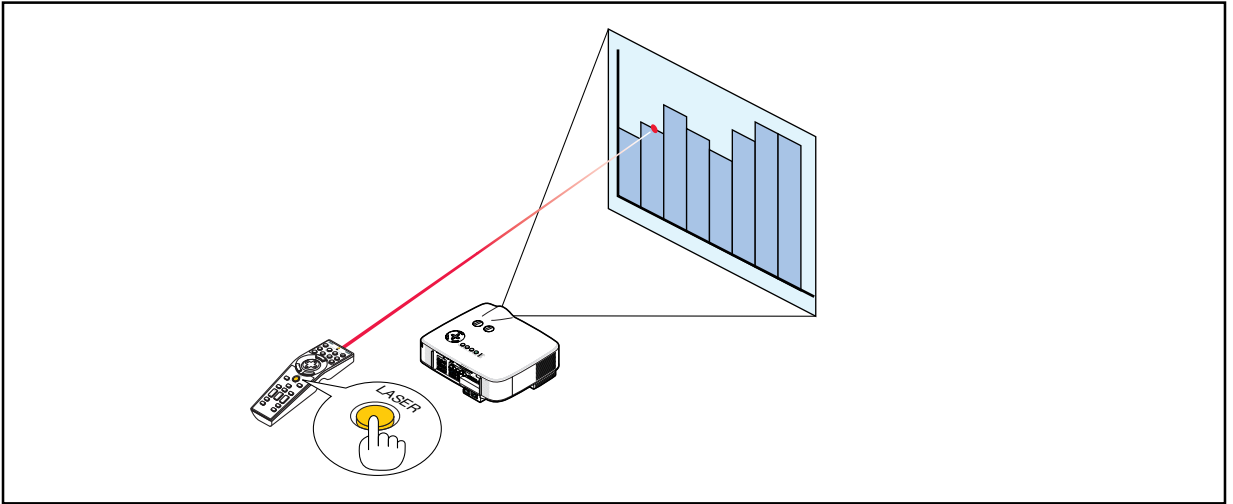

### Setting the function switch

There are two switches on the bottom of the battery case: an applicable projector selector switch (1) and laser enable/disable switch (2). Check the projector being used and decide whether to enable or disable laser, then set these switches as necessary using the tip of a thin ball-point pen. On this model, an applicable projector selector switch (1) is not used.

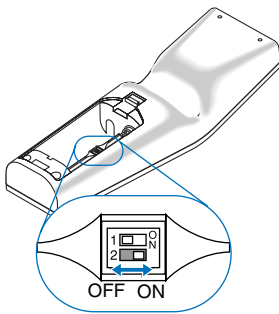

Switch (2)

On ..... Enabled (the laser lights when the LASER button is pressed) [Factory default]

Off ..... Disabled (the laser does not light even when the LASER button is pressed)

Disable the laser when using in an environment in which the unit is accessible to children.



## 8 Turning off the Projector

To turn off the projector:

1. Press the **POWER (ON/STAND BY)** button on the projector cabinet or the **POWER OFF** button on the remote control. The [Power Off / Are you sure?] message will appear.

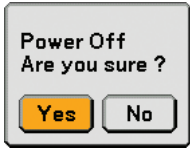

2. Press the **ENTER** button

After the projector turns off, the cooling fans keep operating for a while (Cooling-off time).

The cooling fans stop operating when the projector turns off and goes into standby mode.

When in standby mode, the **POWER** indicator will light orange and the **STATUS** indicator will light green.

3. After making sure that the projector is in standby mode, turn off the **Main Power switch**. The power indicator will go out.

#### About Direct Power Off

The projector has a feature called "Direct Power Off". This feature allows the projector to be turned off (even when projecting an image) using a power strip equipped with a switch and a breaker.

*NOTE: Before using Direct Power Off, be sure to allow at least 20 minutes immediately after turning on the projector and starting to display an image.*

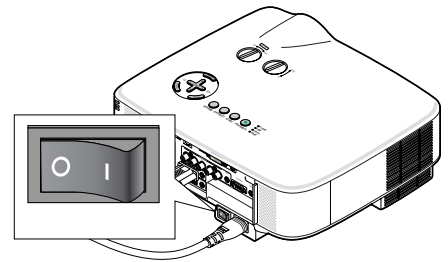
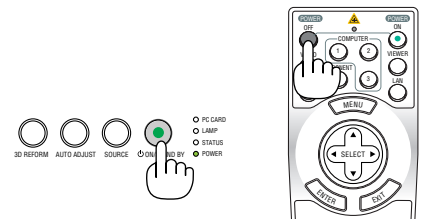
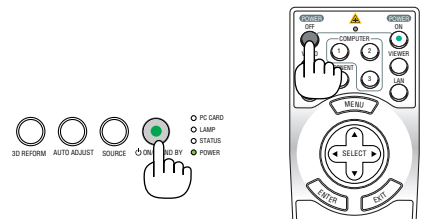

#### CAUTION

- Do not unplug the power cable from the wall outlet or projector when the projector is powered on. Doing so can cause damage to the AC IN connector of the projector and (or) the prong plug of the power cable. To turn off the AC power supply when the projector is powered on, use a power strip equipped with a switch and a breaker.
- Do not turn off the AC power supply within 10 seconds of making adjustment or setting changes and closing the menu. Doing so can cause loss of adjustments and settings and return to default.

**TIP:** The projector can be unplugged during its cool down period after it is turned off.

## 9 After Use

**Preparation:** Make sure that the main power is turned off.

1. **Unplug the power cable.**
2. **Disconnect any other cables.**
3. **Retract adjustable tilt feet if extended.**
4. **Cover the lens with the lens cap.**

# 4. Convenient Features

## 1 Turning Off the Image and Sound

Press the PIC-MUTE button to turn off the image and sound for a short period of time. Press again to restore the image and sound.

*TIP: Even though the image is turned off, the menu still remains on the screen.*

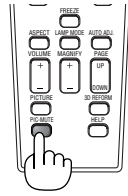

## 2 Freezing a Picture

Press the FREEZE button to freeze a picture. Press again to resume motion.

*TIP: The image is frozen but the original video is still playing back.*

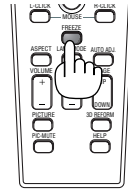

## 3 Enlarging and Moving a Picture

You can enlarge the area you want up to 400 percent.

To do so:

### 1. Press the MAGNIFY (+) button.

Each time the MAGNIFY (+) button is pressed, the image is magnified.

\* Image can be magnified up to 400%

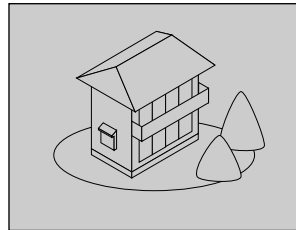

### 2. Press the SELECT ▲▼◀▶ button.

The area of the magnified image will be moved



### 3. Press the MAGNIFY (-) button.

Each time the MAGNIFY (-) button is pressed, the image is reduced.

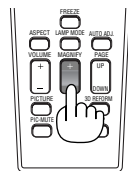
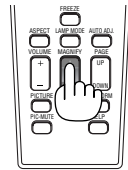
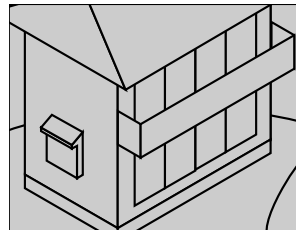

## 4 Changing Lamp Mode

The lamp life can be extended by using the Eco mode.

To change to the [Eco] mode, do the following:

### 1. Press the LAMP MODE button to display [Lamp Mode] screen.

### 2. Use the SELECT ▲ or ▼ button to select [Eco] mode.

### 3. Press the ENTER button. Or press the SELECT ▶ button to select [OK] and press the ENTER button.

To cancel it, select [Cancel] and press the ENTER button.

To change from [Eco] to [Normal], Go back to Step 2 and select [Normal]. Repeat Step 3.

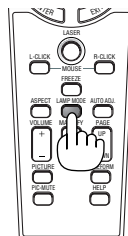

Lamp Mode	Description	Status of LAMP indicator
Normal Mode	This is the Default setting (100% Brightness).	Off
Eco Mode	Select this mode to increase the lamp life (approx. 80% Brightness (light output) on NP2000 and approx. 85% Brightness (light output) on NP1000)	Steady Green light

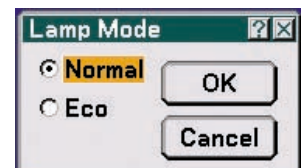

## 5 Getting Integrated Help

You get the contents about Help in English, German and Japanese.

### 1. Press the HELP button on the remote control.

- When no menus appear, the "How to Use Help" screen will be displayed.
- When menus appear, the screen will be displayed, explaining the function of a highlighted item.

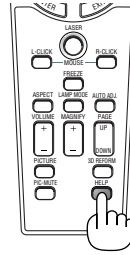

Display Help

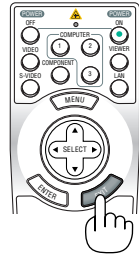

Exit Help

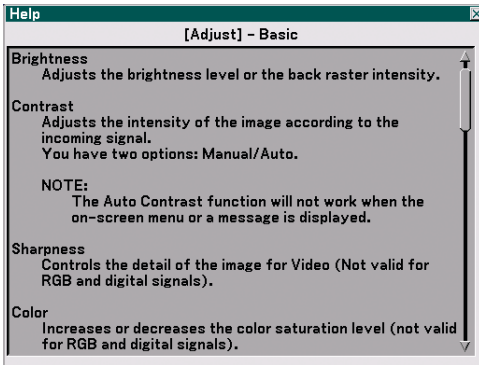

### 2. Use the SELECT ▲ or ▼ button to scroll the viewing area.

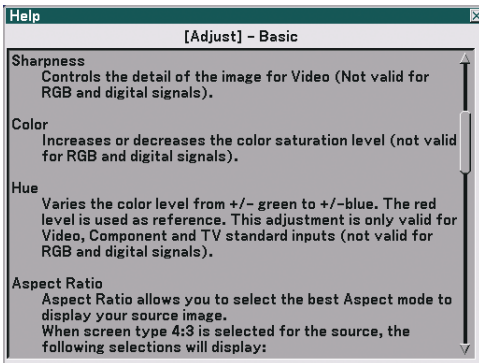

### 3. Press the EXIT button.

- The Help will be closed.

### 6 Using a USB Mouse

Using a USB mouse gives you a smooth operation. A commercially available USB mouse can be used.

*NOTE: There may be some brands of a USB mouse that the projector does not support.*

*NOTE: Do not try to insert the plug of your USB mouse into the LAN port (LAN) of the projector. Doing so can cause damage to the LAN port.*

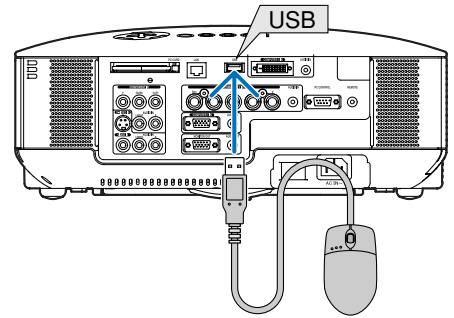

#### Operate the Menus using the USB mouse

##### Mouse Cursor

When connecting a USB mouse to the projector, you get a mouse cursor on the screen. Unless you use your USB mouse within 10 seconds, the mouse cursor disappears.

*NOTE: You can change the shape of the mouse cursor. To do so, select the menu → [Setup] → [Tools] → [Mouse] → [Mouse Pointer].*

##### Menu Display

Clicking with the left mouse button displays the menu. To close the menu, click anywhere in the background.

##### Adjusting and Setting Display

You can select a menu item and click with the left mouse button to make adjustments and settings.

##### Using the middle button on the mouse

The projector supports the middle button on your mouse.

With the middle button you can do the following:

- You can use a scroll bar in the menu or the help.
- You can click the middle button to display or hide the ChalkBoard toolbar.

##### Example:

Click (or press and hold) the left mouse button on the ◀ or ▶ to adjust the brightness. Or click and drag the left mouse button on the slide bar horizontally to adjust it.

To save the adjustments, click . The display is closed.



- Click  with the left mouse button to display a description of the selected menu item.
- Click and drag the title bar with the left mouse button to move the adjustment or setting dialog box.

### ⑦ Using the Optional Remote Mouse Receiver

The optional remote mouse receiver enables you to operate your computer's mouse functions from the remote control. It is a great convenience for your computer-generated presentations.

#### Connecting the remote mouse receiver to your computer

If you wish to use the remote mouse function, connect the mouse receiver and computer. The mouse receiver can be connected directly to the computer's USB port (type A).

---

*NOTE: Depending on the type of connection or OS installed on your computer, you may have to restart your computer or change your computer settings.*

---

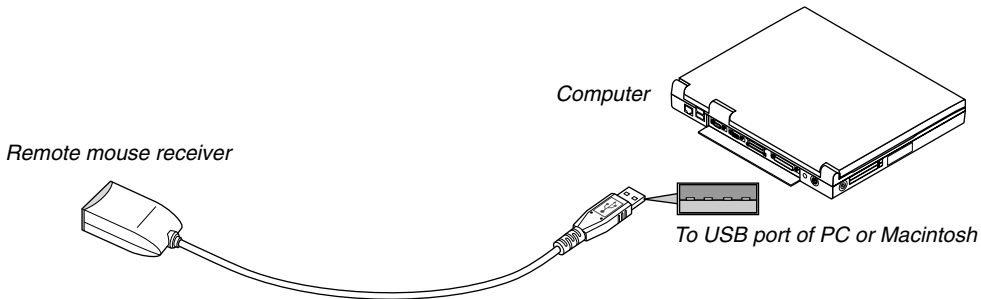

#### When operating a computer via the remote mouse receiver

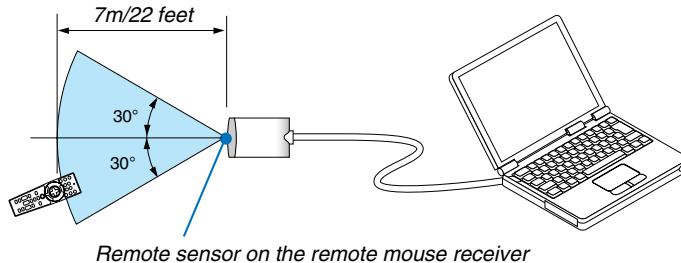

#### When connecting using the USB port

For PC, the mouse receiver can only be used with a Windows 98/Me/XP\*, Windows 2000 or MacOS X 10.0.0 or later operating system.

---

*\* NOTE: In SP1 or older version of Windows XP, if the mouse cursor will not move correctly, do the following: Clear the Enhance pointer precision check box underneath the mouse speed slider in the Mouse Properties dialog box [Pointer Options tab].*

---

---

*NOTE: Wait at least 5 seconds after disconnecting the mouse receiver before reconnecting it and vice versa. The computer may not identify the mouse receiver if it is repeatedly connected and disconnected in rapid intervals.*

---

### Operating your computer's mouse from the remote control

You can operate your computer's mouse from the remote control.

PAGE UP/DOWN Button ..... scrolls the viewing area of the window or to move to the previous or next slide in PowerPoint on your computer.

SELECT ▲▼◀▶ Button ..... moves the mouse cursor on your computer.

MOUSE L-CLICK Button ..... works as the mouse left button.

MOUSE R-CLICK Button ..... works as the mouse right button.

---

*NOTE: When you operate the computer using the SELECT ▲▼◀▶ button with the menu displayed, both the menu and the mouse pointer will be affected. Close the menu and perform the mouse operation.*

---

### About Drag Mode:

By pressing the MOUSE L-CLICK or R-CLICK button for 2 or 3 seconds then releasing, the drag mode is set and the drag operation can be performed simply by pressing the SELECT ▲▼◀▶ button. To drop the item, press the MOUSE L-CLICK (or R-CLICK) button. To cancel it, press the MOUSE R-CLICK (or L-CLICK) button.

*TIP: You can change the Pointer speed on the Mouse Properties dialog box on the Windows. For more information, see the user documentation or online help supplied with your computer.*

## 8 Correcting Horizontal and Vertical Keystone Distortion (Cornerstone)

Use the 3D Reform feature to correct keystone (trapezoidal) distortion to make the top or bottom and the left or right side of the screen longer or shorter so that the projected image is rectangular.

### Cornerstone

1. Press and hold the 3D REFORM button for a minimum of 2 seconds to reset current adjustments.  
Current adjustments for [Keystone] or [Cornerstone] will be cleared.
2. Project an image so that the screen is smaller than the area of the raster.
3. Pick up any one of the corners and align the corner of the image with a corner of the screen.

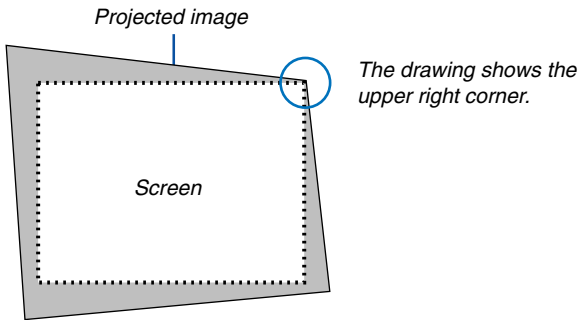

4. Press the 3D REFORM button twice.  
The Cornerstone adjustment screen is displayed.

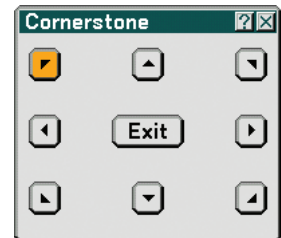
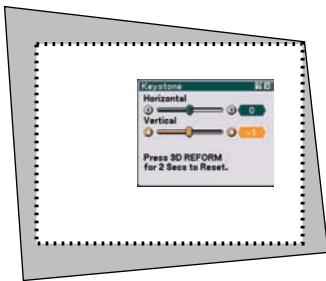

The drawing shows the upper left icon (▲) is selected.

**TIP:** If you are adjusting [Keystone], [Cornerstone] will not be available. If this happens, press and hold the 3D REFORM button for a minimum of 2 seconds to reset the [Keystone] adjustments.

5. Use the SELECT ▲▼◀▶ button to select one icon (▲) which points in the direction you wish to move the projected image frame.
6. Press the ENTER button.

7. Use the **SELECT ▲▼◀▶** button to move the projected image frame as shown on the example.

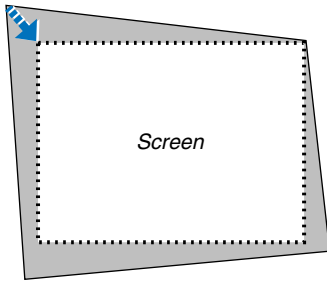

8. Press the **ENTER** button.

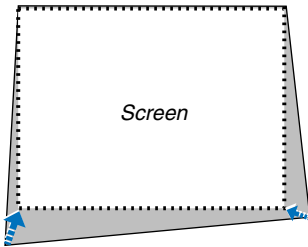

9. Use the **SELECT ▲▼◀▶** button to select another icon which points in the direction.

On the Cornerstone adjustment screen, select [Exit] or press the EXIT button on the remote control.

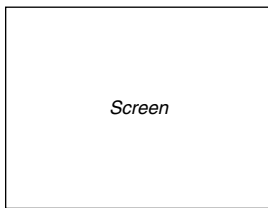

The confirmation screen is displayed.



10. Press the **SELECT ◀ or ▶** button to highlight the [OK] and press the **ENTER** button.

This completes the Cornerstone correction.

Selecting [Cancel] will return to the adjustment screen without saving changes (Step 3).

Selecting [Reset] will return to the factory default.

Selecting [Undo] will exit without saving changes.

---

*NOTE: To reset the 3D Reform correction setting values, press and hold the 3D REFORM button for a minimum of 2 seconds.*

---

*NOTE: During 3D Reform adjustment, [Aspect Ratio] and [Screen] may not be available. Should this happen, first reset the 3D Reform data and then do each setting. Second repeat the 3D Reform adjustment. Changing [Aspect Ratio] and/or [Screen] setting can limit [3D Reform] in its adjustable range.*

---



The adjustable ranges for 3D Reform are as follows:

	Horizontal	Vertical
Cornerstone	Max. +/- 35° approx.	Max. +/- 40° approx.
Keystone	Max. +/- 27° approx.	

\* The following are conditions under which the maximum angle is achieved:

- When the standard lens is used
- When the lens shift is set to the center
- When the lens shift is used and yet the image is not displayed in the center of the screen, the adjustable range will be increased or decreased.
- Image is projected in Wide (Zoom lever)
- Resolution is XGA  
Higher resolution than XGA narrows the adjustable range.
- Menu items should be set as follows:  
Aspect Ratio ..... 4:3  
Screen Type ..... 4:3
- Horizontal and Vertical are adjusted separately.  
A combination of both adjustments narrows the adjustable range.

---

**NOTE:**

- If the Cornerstone screen is unavailable (grayed), press and hold the 3D REFORM button for a minimum of 2 seconds to reset the current correction data. The Cornerstone function becomes available.
  - Turning on the projector will reset the previous correction setting values and correct distortion anew if the projection angle is changed from the last use.  
If the projection angle is the same as in the last use, the previous correction setting values are retained in the memory.
- 

**NOTE:** Using 3D Reform correction can cause the image to be slightly blurred because the correction is made electronically.

---

## 9 Making Freehand Drawings on a Projected Image (ChalkBoard)



The ChalkBoard feature allows you to write and draw messages on a projected image.

*NOTE: Selecting another source will quit the ChalkBoard function.*

*NOTE: The ChalkBoard feature is available only when a USB mouse is used.*

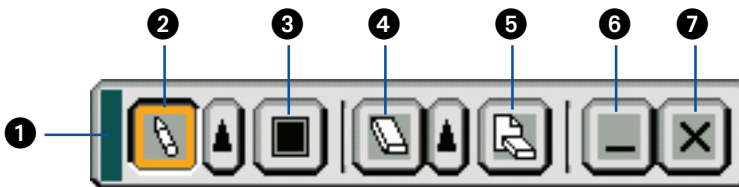
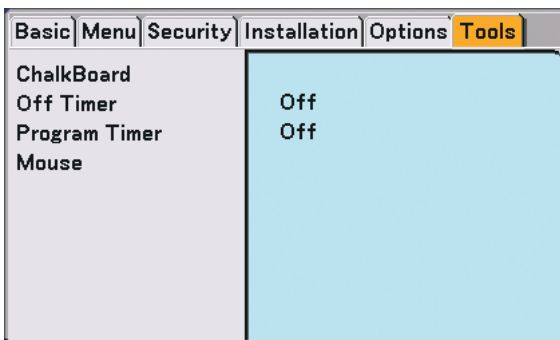
To display the ChalkBoard tool bar, click the middle button on your mouse or select [ChalkBoard] from the menu. The tool bar contains the following icons.



- 1 Drag ..... Drags to move the tool bar.
- 2 Pen ..... Left-click and drag to draw lines freehand. Left-click  or right-click the pen icon to display the pen palette containing four lines of different thickness from which you can select a line you prefer by left-clicking.
- 3 Color ..... Selects the color of a line. Left-click to display the color palette from which you can select a color you prefer by left-clicking.
- 4 Eraser ..... Left-click and drag to erase part of a drawing. Left-click  or right-click the eraser icon to display the eraser palette containing four erasers of different thickness from which you can select an eraser you prefer by left-clicking.
- 5 Clear ..... Left-click to clear the drawing completely from the ChalkBoard screen.
- 6 Hide ..... Hides the tool bar by left-clicking. Right-clicking anywhere on the screen displays the ChalkBoard tool bar again.
- 7 Exit ..... Clears the complete drawing and exits the ChalkBoard.

## 10 Preventing Unauthorized Use of the Projector

Assigning a keyword prevents the projector from being used by unauthorized individuals.

### Assigning a Keyword for the first time

1. Press the **MENU** button.

The menu will be displayed.

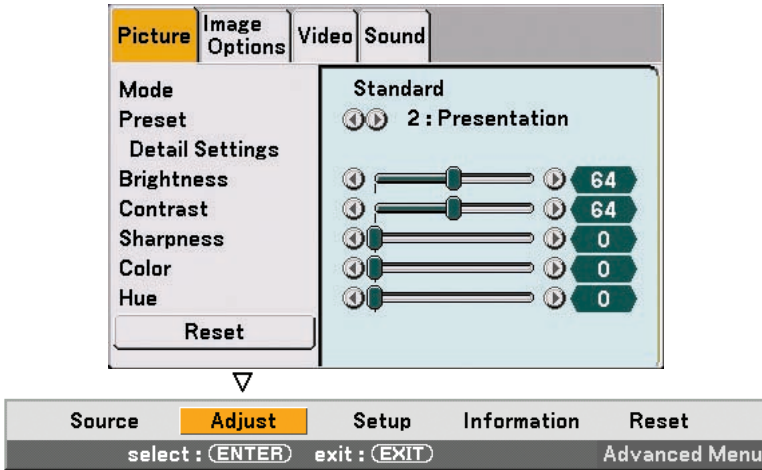

2. Press the **SELECT** ► button to highlight the [Setup] submenu and press the **ENTER** button.

The page tab [Basic] will be highlighted.

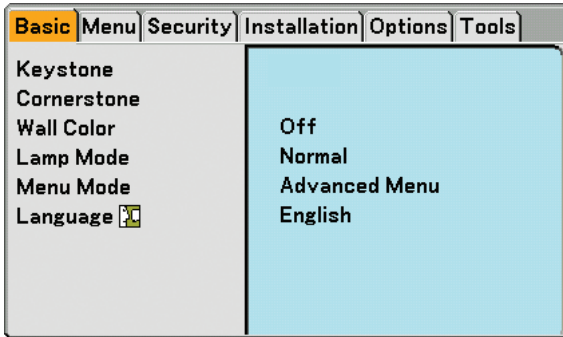

3. Press the **SELECT** ► button twice to highlight the page tab [Security].

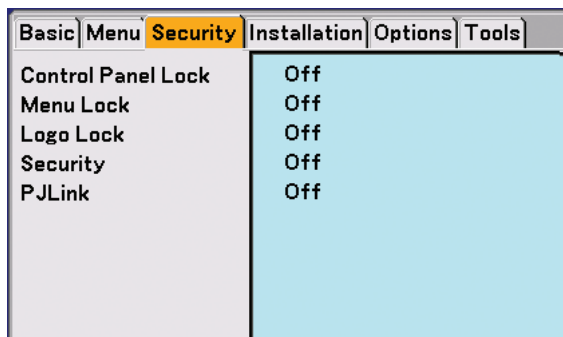

4. Press the **SELECT** ▼ button four times to highlight [Security].

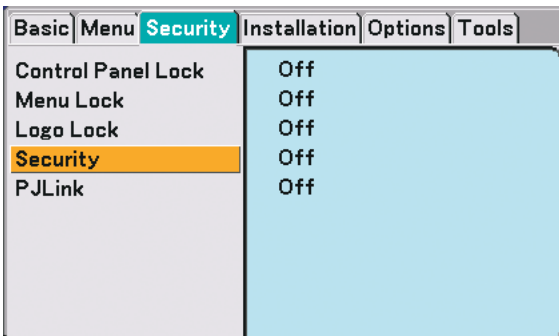

5. Press the **ENTER** button to display the Security screen.

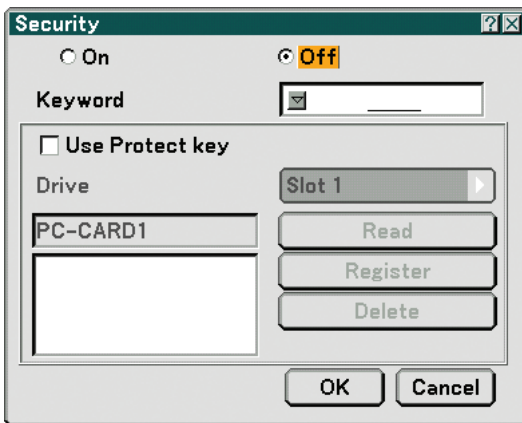

6. Press the **SELECT** ▼ button once to highlight the Keyword entry box and press the **ENTER** button. The Software keyboard will be displayed.

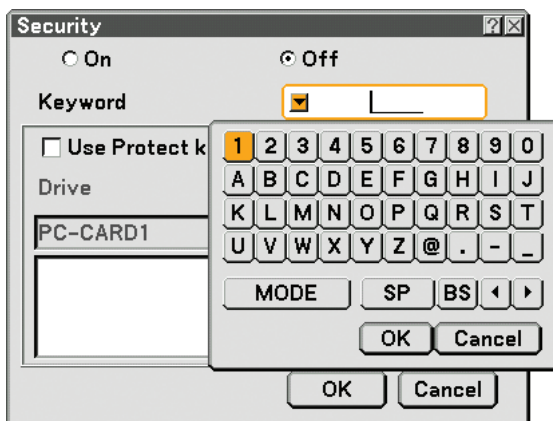

### 7. Enter an alphanumeric keyword using the Software keyboard

For example, to enter "1234", follow the steps 7-1 to 7-4 below.

**NOTE:**

- Please make a note of your keyword.
- Do not use spaces (SP) in your keyword.

7-1. Highlight the number "1" and press the ENTER button.

The asterisk "\*" will be displayed in the Keyword entry box.

7-2. Press the SELECT ► button once to highlight "2" and press the ENTER button.

The asterisk "\*\*" will be displayed in the Keyword entry box.

7-3. For "3" and "4", use the same procedure as step 7-2.

The asterisk "\*\*\*\*" will be displayed in the Keyword entry box.

7-4. Press the SELECT ▼ button to highlight [OK] and press the ENTER button.

The Software keyboard will disappear.

### 8. Press the SELECT ▲ button once to highlight [Off] and press the SELECT ◀ button to highlight [On].

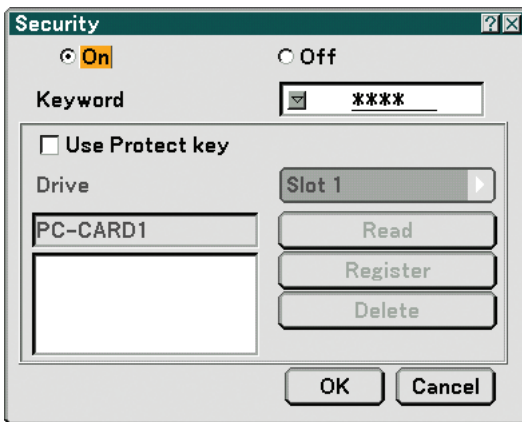

### 9. Press the SELECT ▼ button to highlight [OK] and press the ENTER button.

The confirmation screen will be displayed.

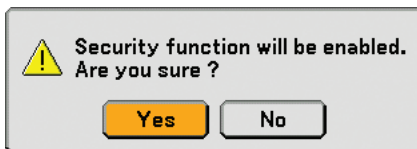

### 10. Press the SELECT ◀ or ► button to highlight [Yes] and press the ENTER button.

The Security Function is now enabled.

**NOTE:** A PC card can be used as a protect key. You can skip the keyword entry by inserting a registered PC card when turning on the projector. (→ page 84)

### Checking If Security is enabled

Turn off the projector and turn it back on to check if the Security function is enabled.

**1. Press the POWER (ON/STANDBY) button.**

The [Power Off / Are you sure?] message will appear.

Press the ENTER button or the POWER (ON/STANDBY) or the POWER OFF button again.

The lamp lights off and the POWER indicator flashes orange. Please wait until the POWER indicator changes from flashing to steady light.

**2. When the POWER indicator lights steady orange, push the Main POWER switch to the off position (O).**

The projector will turn off.

**3. Push the Main POWER switch to the on position (I).**

The POWER indicator lights orange. The projector is in standby condition.

**4. Press and hold the POWER (ON/STANDBY) button for a minimum of two seconds.**

The projector will turn on. The [Projector is locked! Enter your keyword.] message will be displayed at the bottom of the screen.

**5. Press the MENU button.**

The Keyword entry screen will be displayed

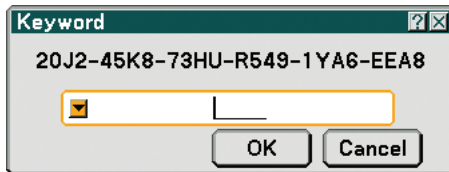

**6. Press the ENTER button.**

The Software keyboard will be displayed.

**7. Use the same procedures as steps 1 to 7 described in the “Assigning a Keyword for the first time” section to enter “1234”.**

Each time one number is entered, an “\*” (asterisk) will appear. Keyword appears as asterisks so the real keyword is hidden.

**8. After entering your keyword, highlight [OK] and press the ENTER button.**

The Software keyboard will disappear. This will allow you to operate the projector.

### Disabling the Security

**1. Press the MENU button.**

The menu will be displayed.

---

*NOTE: Immediately after the projector has been turned on and the "Projector is locked! Enter your keyword." message is displayed at the bottom of the screen, pressing the MENU button will display the Keyword entry will be displayed. At this time, pressing the MENU button will display the menu.*

---

**2. Press the SELECT ► button to highlight [Setup] and press the ENTER button.**

The page tab [Basic] will be highlighted.

**3. Press the SELECT ► button twice to highlight the page tab [Security].**

**4. Press the SELECT ▼ button four times to highlight [Security] and press the ENTER button.**

The Keyword entry screen will be displayed

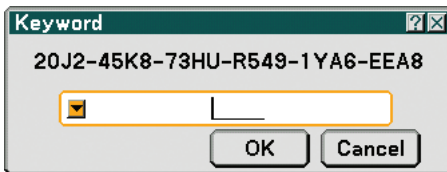

**5. Press the ENTER button.**

The Software keyboard will be displayed.

**6. Use the same procedures as steps 1 to 7 described in the "Assigning a Keyword for the first time" section to enter "1234".**

Each time one number is entered, an "\*" (asterisk) will appear. Keyword appears as asterisks so the real keyword is hidden.

**7. After entering your keyword, highlight [OK] and press the ENTER button.**

The Software keyboard will disappear. The Security screen will be displayed.

**8. Highlight [On] and press the SELECT ► button to highlight [Off].**

**9. Press the SELECT ▼ button to highlight [OK] and press the ENTER button.**

The Security Function is now disabled.

---

*NOTE: Do not forget your keyword. However, if you forget your keyword, NEC or your dealer will provide you with your Release Code upon proof of ownership.*

---

### ① Operation Using an HTTP Browser

#### Overview

The use of HTTP server functions will allow control of the projector from a web browser without the installation of special software. Please be sure to use "Microsoft Internet Explorer 4.x" or a higher version for the web browser. (This device uses "JavaScript" and "Cookies" and the browser should be set to accept these functions. The setting method will vary depending on the version of browser. Please refer to the help files and the other information provided in your software.)

Access is gained to the HTTP server functions by specifying

`http:// <the projector's IP address> /index.html`

in the entry column of the URL.

---

#### NOTE:

- *The display's or button's response can be slowed down or operation may not be accepted depending the settings of your network. Should this happen, consult your network administrator.*
  - *The projector may not respond if its buttons are repeatedly pressed in rapid intervals. Should this happen, wait a moment and repeat. If you still can't get any response, turn off and back on the projector.*
  - *Do not use the HTTP Server functions and PC Control Utility 3.0 included on the supplied CD-ROM. Using both at the same time may result in a connection failure or slow response.*
- 

#### Preparation Before Use

Make network connections and set up the projector and confirm that it is complete before engaging in browser operations. (→ [LAN Mode] on page 89)

Operation with a browser that uses a proxy server may not be possible depending on the type of proxy server and the setting method. Although the type of proxy server will be a factor, it is possible that items that have actually been set will not be displayed depending on the effectiveness of the cache, and the contents set from the browser may not be reflected in operation. It is recommended that a proxy server not be used unless it is unavoidable.

#### Handling of the Address for Operation via a Browser

Regarding the actual address that is entered for the address or entered to the URL column when operation of the projector is via a browser, the host name can be used as it is when the host name corresponding to the IP address of the projector has been registered to the domain name server by a network administrator, or the host name corresponding to the IP address of the projector has been set in the "HOSTS" file of the computer being used.

Example 1: When the host name of the projector has been set to "pj.nec.co.jp",  
`http://pj.nec.co.jp/index.html`  
is specified for the address or the entry column of the URL.

Example 2: When the IP address of the projector is "192.168.73.1", access is gained to the  
HTTP server functions by specifying  
`http://192.168.73.1/index.html`  
for the address or the entry column of the URL.



Structure of the HTTP Server

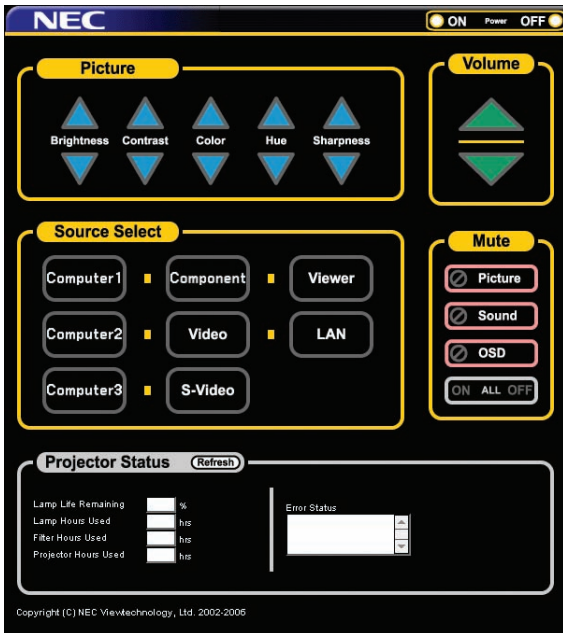

Power: This controls the power of the projector.

- On ..... Power is switched on.
- Off ..... Power is switched off.

Volume: This controls the volume of the projector.

- ▲ ..... Increases the volume adjustment value.
- ▼ ..... Decreases the volume adjustment value.

Mute: This controls the mute function of the projector.

- Picture On ..... Mutes the video.
- Picture Off ..... Cancels the video muting.
- Sound On ..... Mutes the audio.
- Sound Off ..... Cancels the audio muting.
- OSD On ..... Mutes the on-screen display.
- OSD Off ..... Cancels the muting of the on-screen display.
- All On ..... Mutes each of the video, audio, and on-screen display functions.
- All Off ..... Cancels the muting of each of the video, audio, and on-screen display functions.

Picture: Controls the video adjustment of the projector.

- Brightness ▲ ... Increases the brightness adjustment value.
- Brightness ▼ ... Decreases the brightness adjustment value.
- Contrast ▲ ..... Increases the contrast adjustment value.
- Contrast ▼ ..... Decreases the contrast adjustment value.
- Color ▲ ..... Increases the color adjustment value.
- Color ▼ ..... Decreases the color adjustment value.
- Hue ▲ ..... Increases the hue adjustment value.
- Hue ▼ ..... Decreases the hue adjustment value.
- Sharpness ▲... Increases the sharpness adjustment value.
- Sharpness ▼... Decreases the sharpness adjustment value.

- The functions that can be controlled will vary depending on the signal being input to the projector. (→ page 74)

Source Select: This switches the input connector of the projector.

- Computer1 ..... Switches to the COMPUTER 1 IN connector.
- Computer2 ..... Switches to the COMPUTER 2 IN connector.
- Computer3 ..... Switches to the COMPUTER 3 IN connector.
- Component ..... Switches to the COMPONENT IN connectors.
- Video ..... Switches to the VIDEO IN connector.
- S-Video ..... Switches to the S-VIDEO IN connector.
- Viewer ..... Switches to the data on the PC card or USB memory device.
- LAN ..... Switches to a LAN signal.

Projector Status: This displays the condition of the projector.

- Refresh ..... Updates the display of the following conditions.
- Lamp Life Remaining ..... Displays the remaining life of the lamp as a percentage.
- Lamp Hours Used ..... Displays how many hours the lamp has been used.
- Filter Hours Used ..... Displays how many hours the filter has been used.
- Projector Hours Used . Displays how many hours the projector has been used.
- Error Status ..... Displays the status of errors occurring within the projector.

## 12 Using the Projector to Operate a Computer Connected on a Network (Desktop Control Utility 1.0)

When Desktop Control Utility 1.0 on the included User Supportware 3 CD-ROM is installed on the computer, that computer can be operated using the projector over a network. For example, say you have a PowerPoint file on a computer in your office that you want to use for a presentation at a meeting. If the computer in the office is connected by LAN to the projector in the meeting room, the projector can be operated to project the image of the desktop of the computer (Windows 2000/Windows XP) in the office and display the PowerPoint file during the meeting. This eliminates the need for taking the computer from the office to the meeting room.

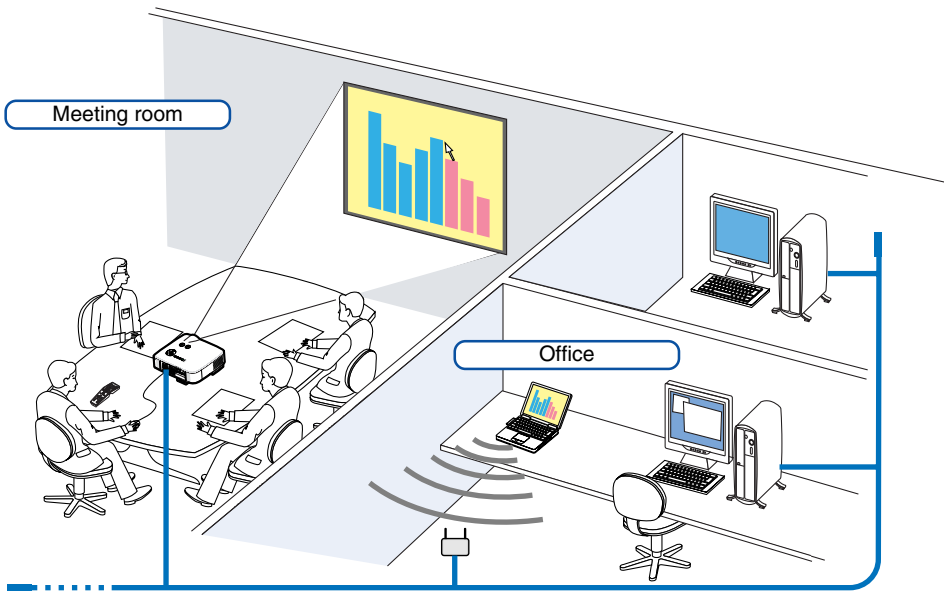

### Disclaimer

You can use the Desktop Control Utility 1.0 to operate a computer located in a separate room from the projector over a network. This means there might be potential security risks that you may be exposed to which could cause damage by unauthorized access or illegal use. We recommend you take some measures to prevent third parties from unauthorized access to your data or information.

We share neither liability nor responsibility to any loss or damages arising from information leak or power down without notice.

---

*NOTE: In Windows operating system, click [Control Panel] → [Power Options] → [System Standby] → [Never]. This will disconnect a LAN connection when the computer goes in standby mode.*

---

*NOTE: To use the Desktop Control Utility 1.0, you need to have a USB mouse inserted into the USB port of the projector.*

---

### Operations on the Computer

1. **Connect the computer to the LAN and make the required settings.**

2. **Install Desktop Control Utility 1.0 on the computer.**

- For instructions on installing and operating the software, see the "User Supportware 3 User's Guide" (PDF) contained on User Supportware 3 CD-ROM.

3. **Prepare the documents to be presented at the meeting and save them on the computer.**

4. **Start up Desktop Control Utility 1.0.**

**The Startup password window appears.**

*Window at the first startup*

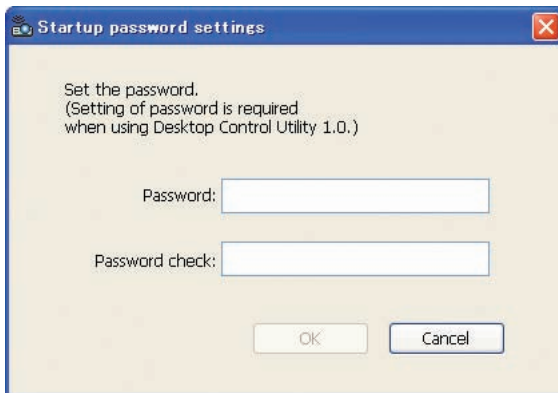

*Window after entering your startup password*



#### **Important:**

- Your startup password will be required each time you start Desktop Control Utility 1.0.
- If you forget or lost your startup password, install the program again.

5. **Input the startup password and click [OK].**

**The [Current password] input window appears.**



---

**NOTE:** The [Current password] will be changed each time you start Desktop Control Utility 1.0.

---

6. **Make a note of the password.**

7. **Click [OK].**

**Desktop Control Utility 1.0 starts.**

Go to the room where the projector is installed, taking the password you made a note in the previous Step [6].

### Operations on the projector – Connecting to the computer

1. Make the LAN settings on the projector.

Make the LAN settings at [Setup] → [Installation] → [LAN Mode] in the menu. (→ page 89)

2. Connect a commercially available USB mouse to the projector. (→ page 38)
3. Click anywhere on the screen with the USB mouse.

The menu appears.

4. Click [Source], then click [LAN].

The help message is displayed.

The message is displayed only when a password for Desktop Control Utility 1.0 is not assigned.



5. Follow the message to press the MENU button on the projector cabinet or the remote control. The connections bar appears at the bottom left of the screen.



6. Click the password input icon .
7. Click [Entry].



The password input window appears.

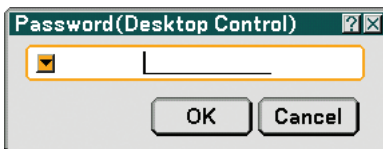

8. Click .



The character input window appears. (→ page 128)

9. *Input the password you made a note of in the previous Step 6 in “Operations on the Computer”.*
10. *Input the password and click [OK].*  
*The password input window is turned off.*

11. *Click the PC search icon .*  
*The PC search window appears.*

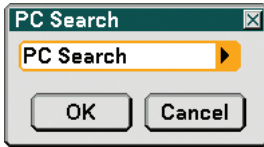

12. *Click [OK].*  
*The connection selection window appears.*
  - *To search by inputting the IP address of the connected computer, click  on the PC Search window, click [Input IP Address], then click [OK].*
13. *Click the computer to which you want to connect, then click [OK].*  
*The desktop of the connected computer appears.*







*NOTE: Once the desktop appears, the menu will no longer appear when the USB mouse is clicked. To display the menu while the desktop is displayed, press the button on the projector itself or on the remote control.*

### Operations on the projector –Operating the desktop

A USB mouse connected to the projector can be used to operate the displayed desktop. If the MENU button on the projector cabinet or the remote control is pressed while the desktop is displayed, an additional operations bar appears at the bottom left of the screen.



The following operations are available only with buttons on the projector cabinet or the remote control.

- ①  Disconnect icon ..... Use to cut off communications with the computer.
- ②  Shift icon ..... Select this icon and press the ENTER button to set the shift lock mode. Select this icon and press the ENTER button again to cancel the shift lock mode.
- ③  Ctrl icon ..... Select this icon and press the ENTER button to set the control lock mode. Select this icon and press the ENTER button again to cancel the control lock mode.
- ④  Esc icon ..... Use to do the same operation as when the “Esc” button on the computer is pressed. Use it for example to stop a PowerPoint slideshow.

### Operations on the projector – Disconnecting communication

1. Press the MENU button while the desktop is displayed.

*The additional operations bar appears at the bottom left of the screen.*



2. Select the disconnect icon  and press the ENTER button.

*The connections bar appears at the bottom left of the screen.*

To reconnect the communication, click the PC search icon  and repeat steps 12 and 13 in the previous page.

---

*NOTE: Disconnection is possible by clicking the projector icon and then “Disconnect” on the task bar.*

---

### Operations on the projector – Exiting the desktop operation

Exiting the desktop operation using the taskbar in Windows.

1. Click the projector icon  on the taskbar while the desktop is displayed.

*The pop-up menu appears.*

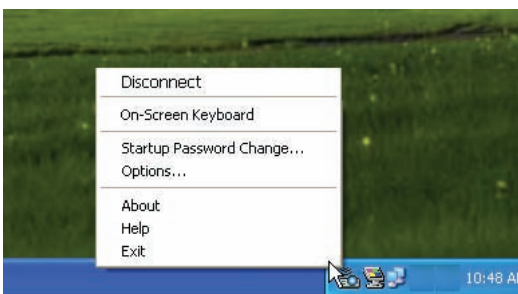

2. Click [Exit].

*Desktop Control Utility 1.0 quits*

3. Click anywhere on the screen.

*The connections bar appears at the bottom left of the screen.*

4. Click again anywhere on the screen.

*The menu appears.*

5. Click [Source] and then click any other source than [LAN].

*The menu turns off.*

# 5. Using the Viewer

---

## ① Making the Most out of the Viewer Function

### Features

The Viewer feature allows you to view slides stored on a PC memory card (referred to as PC card in this manual) or USB memory on the projector. Even if no computer is available, presentations can be conducted simply with the projector. This feature is convenient for holding presentations at meetings and in offices, as well as for playing images taken on digital cameras.

### Easy to use

- Presentations can be started immediately simply by inserting a PC card or USB memory (not supplied)
- Easy slide switching
- Remote control operation
- Jumping to a list of slides or any specific slide

### Simple utility software (for computer)

- Ulead Photo Explorer 8.0SE Basic operable on Windows XP/Windows 2000.
- Slides can be created by capturing the currently displayed image.
- Control screen for displaying lists of slides and editing.
- \* Microsoft, Windows and PowerPoint are registered trademarks of Microsoft Corporation.

### TIP:

- *To use the Viewer, first you need to create presentation materials on your PC (JPEG, BMP, GIF\*1, PNG\*1, Index\*2 files). For creating presentation materials using the Ulead Photo Explorer 8.0, see the supplied "User Supportware 3 User's Guide" or On-line help in Ulead Photo Explorer 8.0.*
  - \*1 Both PNG and GIF format support non-interlaced images only.
  - \*2 "Index" file is a file created using the Ulead Photo Explorer 8.0 contained on the supplied NEC User Supportware 3 CD-ROM. See the supplied "User Supportware 3 User's Guide" for installing the Ulead Photo Explorer 8.0 on your computer.

---

### NOTE:

- Use commercially available USB memory devices.
  - The PC Card slot accepts PCMCIA Type II only.
  - Some USB memory devices (brands) may not work. See our website for available USB memory devices:<http://www.nec-pj.com>
  - The projector does not support NTFS formatted flash memory card or USB memory device.  
*Be sure to use a flash memory card or USB memory device formatted with the FAT32, FAT16 or FAT file system.  
To format your flash memory card or USB memory device in your computer, refer to the document or help file that comes with your Windows.*
-



### ② Saving data to a PC card or USB memory device

There are two ways to save your data to a PC card or USB memory device.

#### **Using Ulead Photo Explorer 8.0**

Install Ulead Photo Explorer 8.0 from the supplied User Supportware 3 CD-ROM to your computer. Use Ulead Photo Explorer 8.0 to create PowerPoint files or graphic data on your computer and save the files to a PC card or USB memory device.

Files created on Ulead Photo Explorer 8.0 are index format.

For more details about Ulead Photo Explorer 8.0, see the supplied "Wired and Wireless Network Setup Guide", "Basic Operation Guide (PDF)" on the User Supportware 3 CD-ROM and the help file of Ulead Photo Explorer 8.0.

#### **Using Windows Explorer to save files**

Supported file format for Viewer are JPEG, BMP, PNG, GIF and Index.

### ③ Operating the Viewer Function from the Projector (playback)

This section describes the operation for showing slides created using the Viewer function with the projector. It is also possible to make slides directly from the images projected with the projector.

#### Projecting slides (Viewer)

Preparation: Store JPEG or BMP files (JPEG, BMP, non-interlaced GIF or non-interlaced PNG files) in a PC card or USB memory inserted into your PC.

To start the Viewer, press the SOURCE button on the cabinet to select [Viewer]. (→ page 26)

Viewer screen will be displayed. (A slide will be displayed at the factory default.)

- You can use the VIEWER button on the remote control to select [Viewer].

#### Operating Viewer Menu

1. Insert a PC card into the PC card slot or USB memory into the USB port of the projector.
2. Press the VIEWER button on the remote control or select the [Viewer] from the source list.  
*An image stored in the PC card or USB memory will be displayed.*
3. Press the MENU button to display the Viewer menu.

The Viewer menu will appear when you press the MENU button on the remote control or the projector cabinet.

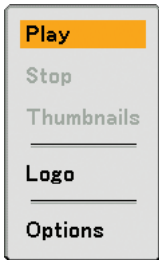

The Viewer menu includes the following commands:

- Play ..... Plays back automatically or manually depending on the setting in Options. This allows you to move on to the next slide when [Manual] is selected in the [Play Mode].
- Stop ..... This allows you to stop Auto Play while you are playing back and to resume playing from the selected slide or folder when [Auto] is selected in the [Play Mode].
- Thumbnails ..... Displays a list of thumbnails of Graphic files stored in the PC card or USB memory inserted into the projector.
- Logo ..... Replace the default background logo with another logo in JPEG, BMP, non-interlaced GIF or non-interlaced PNG format.
- Options ..... Displays the Viewer setting options.

4. Select [Play] and then press the ENTER button to display the first slide or to start playing slides automatically.

**Viewer Window Elements**

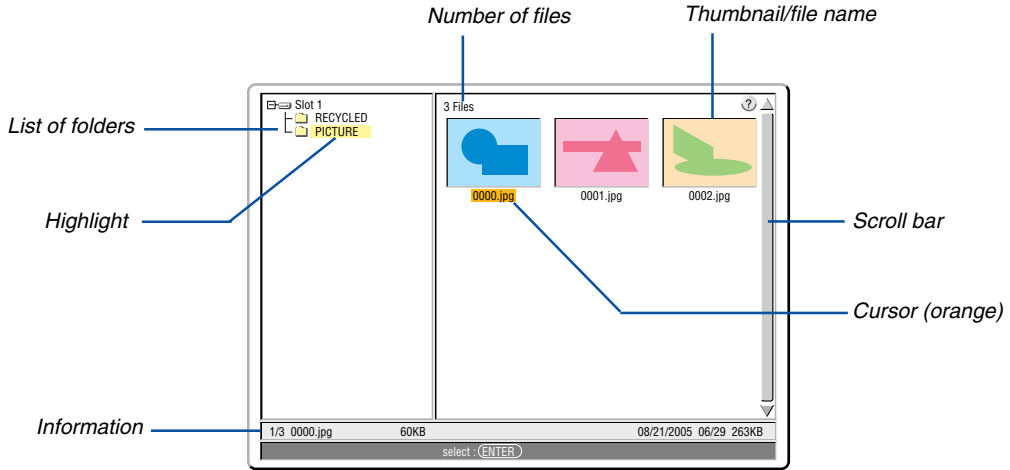

- Highlight ..... Indicates the selected folder or drive.
- List of folders ..... Indicates folders contained on a PC card or USB memory.
- Information ..... Indicates information of the selected file or folder.  
 Folder: folder name, creation date (month/day/year), creation time (hour/minute).  
 File: slide number/number of displayable slides in a folder, file name, creation date (month/day/year), creation time (hour/minute), file size.
- Number of files ..... Indicates number of displayable slides in the selected folder. The maximum number of images recognized as slides within one directory is about 250.
- Thumbnail/file name ..... Indicates thumbnails and names contained in a folder.
- Cursor ..... Indicates the selected slide.
- Scroll bar ..... Used to view folders or files not visible in the window.

**Setting Option for Viewer**

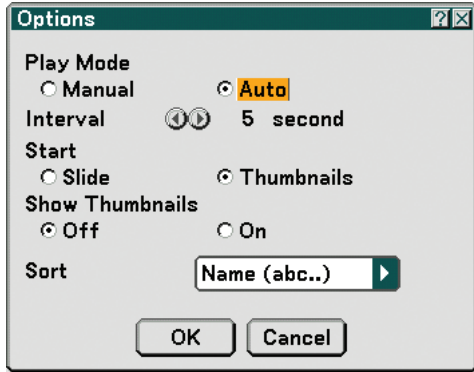

**Play Mode:**

- Manual ..... Views a slide manually when the Viewer source is selected.
- Auto ..... Plays back slides automatically when the Viewer source is selected.

**Interval:**

Specifies interval time between 5 and 300 seconds.

**Start:**

Specifies start screen when the Viewer source is selected.

**Show Thumbnails:**

Selecting the Viewer source will display a list of thumbnails of graphic files stored in the PC card or USB memory when [On] is selected.

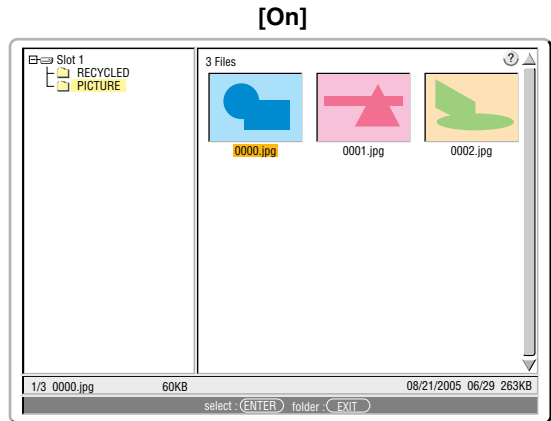
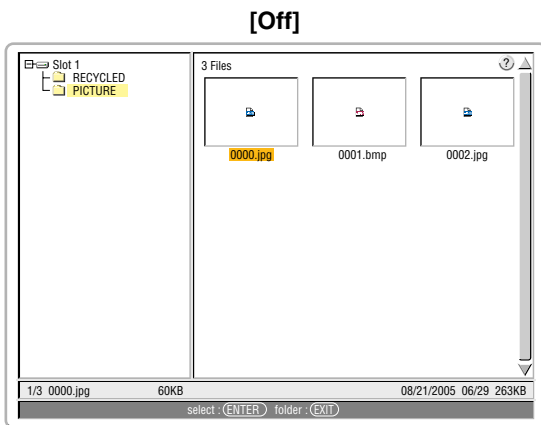

**Sort:**

Rearranges the slides or thumbnails by name, extension, date or size.

*NOTE: This setting is not available for the following folders:*

*\* Folders created with the "Output Viewer" feature of Ulead Photo Explorer 8.0 or with Viewer PPT Converter 3.0*

**OK/Cancel:**

- To close the Options menu with saving changes, select [OK] and press the ENTER button.
- To close the Options menu without saving changes, select [Cancel] and press the ENTER button.

### Exiting Viewer

To exit Viewer, switch to another input such as Computer 1, Computer 2, Computer 3, Component, Video, S-Video or LAN.

- \* To switch to another input, there are two ways:
- \* Press the COMPUTER 1, COMPUTER 2, COMPUTER 3, COMPONENT, VIDEO, S-VIDEO or LAN button on the remote control.
- \* Press the MENU button on the remote control to display the Viewer menu. Press the MENU button again to display the main menu and select the input from the [Source] submenu.

With this function it is possible to switch directly to a slide when the picture of a VCR or computer is being projected. Example: When conducting presentations using a combination of slides and moving pictures from a VCR, etc., it is possible to switch from a Viewer slide to the video picture then back to the Viewer slide simply by using the Viewer button.

---

*NOTE: Even if you switch the current Viewer source to another source, the current slide is retained. When you return back to the Viewer, you will get the slide that has been retained.*

---

### Viewing Digital Images

Digital images can be played with the Viewer if the following conditions are met:

- If the image can be stored on an MS-DOS format PC card.
- If the image can be stored in a format supported by the Viewer. With the Viewer, images on the card are searched for in directories and images in JPEG, BMP, non-interlaced GIF or non-interlaced PNG format are recognized as slides.

---

*NOTE: The maximum number of images recognized as slides within one directory is about 250.*

---

## 4 Changing Background Logo

You can change the default background logo using the Viewer feature.

*NOTE: File size must be 256KB or less. File formats other than JPEG, BMP, non-interlaced GIF or non-interlaced PNG are not available.*

Preparation: Store JPEG or BMP files (JPEG, BMP, non-interlaced GIF or non-interlaced PNG files) in a PC card or USB memory inserted into your PC and insert the PC card into the projector's slot or USB memory into the projector's USB port.

1. Press the **VIEWER** button on the remote control to display an image.
2. Press the **MENU** button to display the Viewer menu.



3. Use the **▼** button to select [Thumbnails] and then press the **ENTER** button.  
The Thumbnail screen will be displayed.

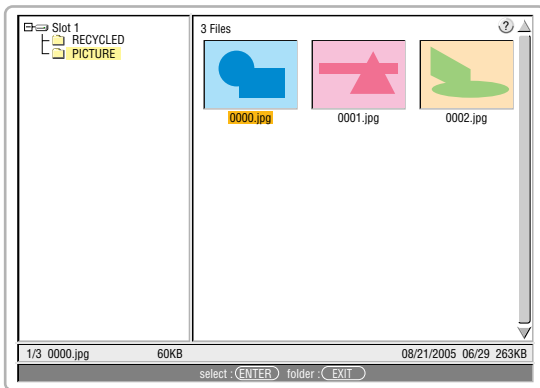

*NOTE: To change highlight from the Thumbnails screen (right window) to a directory tree (left window), press the **EXIT** button. To return highlight to the Thumbnails screen, press the **ENTER** button.*

4. Use **▲▼◀▶** button to select a file (slide) for your background logo.
5. Press the **MENU** button to display the Viewer menu.
6. Use the **▼** button to select [Logo] and then press the **ENTER** button.  
A confirmation dialog box will be displayed.



7. Use the **◀** button to select [Yes] and press the **ENTER** button. This completes changing a logo for the background.

\* Once you have changed the background from the NEC logo to another, you cannot return the logo to background even by using [Reset]. To put the NEC logo back in the background logo, repeat the above steps. The NEC logo file is included on the supplied User Supportware 3 CD-ROM (/Logo/NEC\_BB\_X.JPG).

# 6. Using On-Screen Menu

## ① Using the Menus

1. Press the **MENU** button on the remote control or the projector cabinet to display the menu.

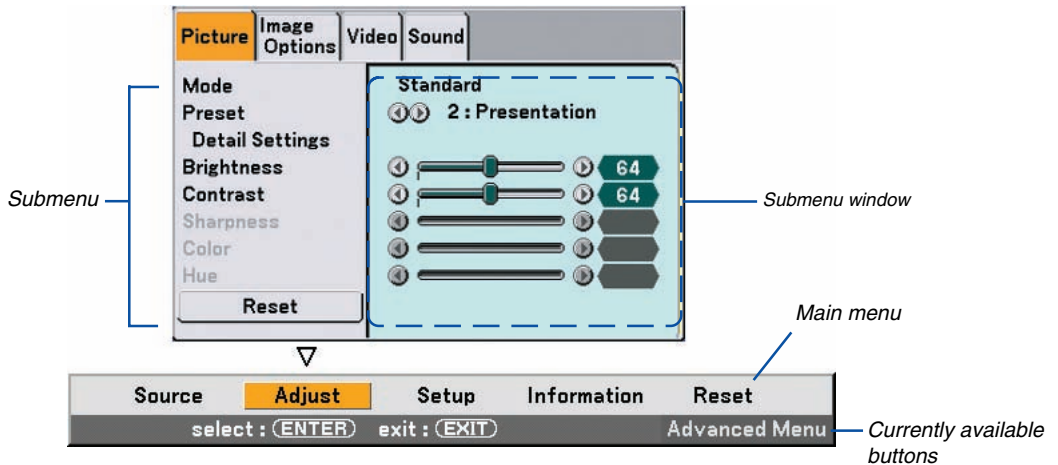

*NOTE: The commands such as ◀▶, ENTER, EXIT in the gray bar show available buttons for your operation.*

2. Press the **SELECT** ◀▶ buttons on the remote control or the projector cabinet to display the submenu.
3. Press the **ENTER** button on the remote control or the projector cabinet to highlight the top item or the first tab.
4. Use the **SELECT** ▲▼ buttons on the remote control or the projector cabinet to select the item you want to adjust or set.  
You can use the **SELECT** ◀▶ buttons on the remote control or the projector cabinet to select the tab you want.

*NOTE: You can select a tab only when the tab color is orange.*

5. Press the **ENTER** button on the remote control or the projector cabinet to display the submenu window.
6. Adjust the level or turn the selected item on or off by using the **SELECT** ▲▼◀▶ buttons on the remote control or the projector cabinet.  
Changes are stored until you adjust it again.
7. Repeat steps 2 -6 to adjust an additional item, or press the **EXIT** button on the remote control or the projector cabinet to quit the menu display.

*NOTE: When a menu or message is displayed, several lines of information may be lost, depending on the signal or settings.*

## 2 Menu tree

Basic menu items are indicated by shaded area.

Factory default settings are indicated by the gray shaded area.

Menu	Item					
Source	Computer 1, Computer 2, Computer 3, Component, Video, S-Video, Viewer, LAN, Entry List					
Adjust	Picture	Mode	Standard, Professional			
		Preset	1 to 6			
			Detail Settings	General	Reference	High-Bright, Presentation, Video, Movie, Graphic, sRGB
					Gamma Correction	Dynamic, Natural, Black Detail
					Color Temperature	5000, 6500, 7800, 8500, 9300, 10500
				White Balance	Brightness RGB, Contrast RGB	
				Color Correction	Red, Green, Blue, Yellow, Magenta, Cyan	
			Brightness			
			Contrast	Manual, Auto		
			Sharpness			
			Color			
			Hue			
			Reset			
		Image Options	Image Options	Clock		
Phase						
Horizontal Position						
Vertical Position						
Blanking	Top, Bottom, Left, Right					
Overscan	0%, 5%, 10%					
Aspect Ratio	4:3			4:3, Letterbox, Wide Screen, Crop		
	16:9			4:3 Window, Letterbox, Wide Screen, 4:3 Fill		
Video	Video			3D Y/C Separation	Off, On: Still, Normal, Movie	
				Vertical Enhancer	Off, 1, 2, 3	
		Deinterlace	Off, On: Still, Normal, Movie			
		Telecine	Off, On: 2-2/2-3 Auto, 2-2 On, 2-3 On			
		Contrast Enhancement	Off, On, Split, Adjust			
Sound	Sound	Volume, Bass, Treble, Balance, 3D Surround (Off, On)				
Setup	Basic	Keystone	Horizontal, Vertical			
		Cornerstone				
		Wall Color	Off, Blackboard, Blackboard (Gray), Light yellow, Light green, Light blue, Sky blue, Light rose, Pink			
		Lamp mode	Normal, Eco			
		Menu Mode	Basic Menu, Advanced Menu			
		Language	English, Deutsch, Français, Italiano, Español, Svenska, Suomi, Norsk, Nederlands, Türkçe, Polski, Русский, Ελληνικά, Magyar, Português, Čeština, العربية, Dansk, 日本語, 한국어, 中文			
		Menu	Menu	Color Select	Color1 to 5, Monochrome	
Display Select	Source: On, Off / Message: On, Off / Time: On, Off					
Display Time	Manual, Auto 5 sec, Auto 15 sec, Auto 45 sec					
Background	Blue, Black, Logo					
Security	Security	Control Panel Lock	Off, On			
		Menu Lock	Off, On			
		Logo Lock	Off, On			
		Security	Off, On, Keyword, Use Protect Key, Drive, Read, Register, Delete			
		PJLink	Off, On			
		Password				



## 6. Using On-Screen Menu

Menu	Item						
Setup	Installation	Orientation	Desktop Front, Ceiling Rear, Desktop Rear, Ceiling Front				
		Screen	Screen Type: 4:3, 16:9 / Position				
		LAN Mode	Built-in	Profiles:	Profile 1, Profile 2		
				DHCP:	On, Off		
				IP Address			
				Subnet Mask			
				Gateway			
				DNS Configuration			
				Reconnect			
				PC Card		Profiles:	Easy Connection, Profile 1, Profile 2
						DHCP:	On, Off
						IP Address	
						Subnet Mask	
						Gateway	
						DNS Configuration	
		Domain		Advanced:	Network Type: Site Survey, SSID, Mode, Channel WEP: WEP, Key Select, Key 1-4		
				Reconnect			
				Host Name			
		Mail		Domain Name			
				Alert Mail:	On, Off		
		Options		Sender's Address			
				SMTP Server Name			
				Recipient's Address 1-3			
				Test Mail			
				Projector Name			
				Communication Speed	4800bps, 9600bps, 19200bps, 38400bps		
				Date, Time Preset	Date: Month / Day / Year, Time: (H / M)		
Remote Sensor	Front / Back, Front, Back						
Auto Adjust	Off, Normal, Fine						
Auto Start	Off, On						
Power Management	Off, 0:05, 0:10, 0:20, 0:30						
Fan Mode	Auto, High						
Default Source Select	Last, Auto, Select (Computer1, Computer2, Computer3, Component, Video, S-Video, Viewer, LAN)						
Signal Select	Computer1			RGB/Component, RGB, Componet, Scart			
	Computer2			RGB/Component, RGB, Componet			
	Component			Component, Video			
Color System	Component (Video), Video, S-Video						
S-Video Mode Select	Off, S2						
OUT Terminal	Last, Computer1, Computer2, Component						
Tools				ChalkBoard			
				Off Timer	Off, 0:30, 1:00, 2:00, 4:00, 8:00, 12:00, 16:00		
				Program Timer			
				Mouse	Mouse Pointer: Pointer 1 to Pointer 9 / Button: Right Hand, Left Hand Sensitivity: Fast, Medium, Slow		
Information				Usage Time	Lamp Life Remaining, Lamp Hours Used, Filter Hours Used, Projector Hours Used		
				Source Page1	Input Terminal, Signal Type, Video Type, Source Name, Entry No.		
				Source Page2	Horizontal Frequency, Vertical Frequency, Sync Type, Sync Polarity, Scan Type		
				LAN Built-in	IP Address, Subnet Mask, Gateway, MAC Address		
		LAN PC Card	IP Address, Subnet Mask, Gateway, MAC Address				
		LAN Wireless	SSID, Mode, WEP, Channel, Signal Level				
		Version	Model, Serial Number, Firmware, Data				
Reset		Current Signal, All Data, All Data (Including Entry List), Clear Lamp Hours, Clear Filter Hours					

### 3 Menu Elements

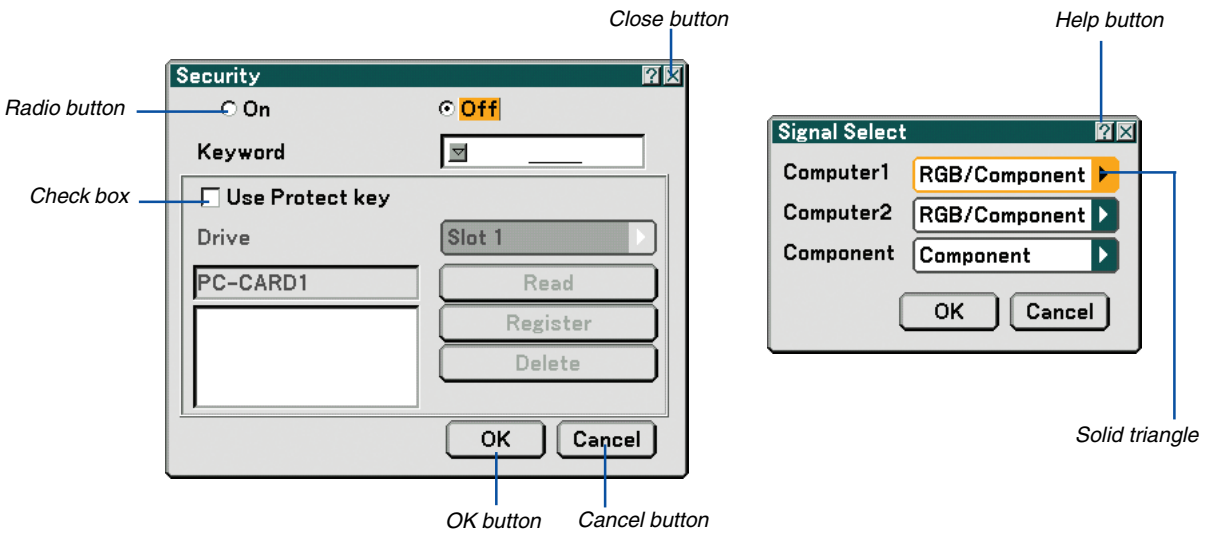
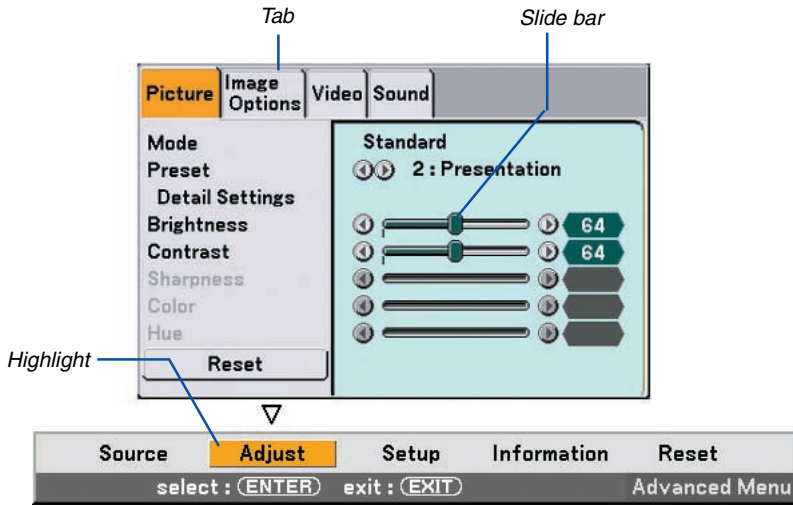

**Menu windows or dialog boxes typically have the following elements:**

- Highlight..... Indicates the selected menu or item.
- Solid triangle ..... Indicates further choices are available. A highlighted triangle indicates the item is active.
- Tab ..... Indicates a group of features in a dialog box. Selecting on any tab brings its page to the front.
- Radio button ..... Use this round button to select an option in a dialog box.
- Check box ..... Place a checkmark in the square box to turn the option On.
- Slide bar ..... Indicates settings or the direction of adjustment.
- OK button ..... Press to confirm your setting. You will return to the previous menu.
- Cancel button ..... Press to cancel your setting. You will return to the previous menu.
- Close button ..... Click to close the window and saving changes. (USB mouse only)
- Help button ..... Indicates that help about that feature is available (USB mouse only). Press the HELP button on the remote control to display help.

## 4 Menu Descriptions & Functions [Source]

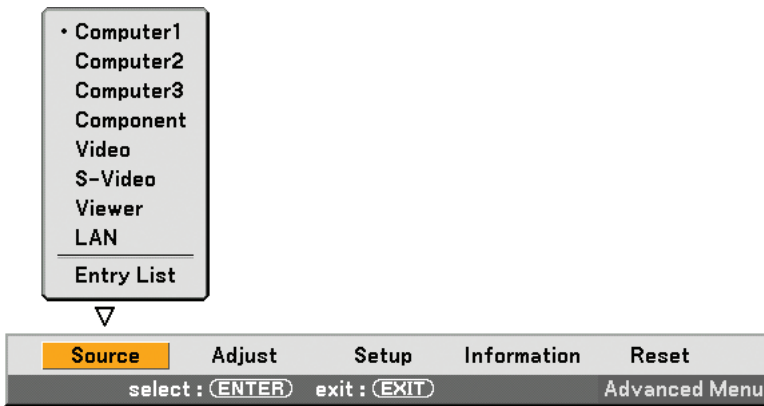

### Computer 1 and 2

Selects the computer connected to your COMPUTER 1 or COMPUTER 2 input connector signal.

*NOTE: An optional component cable (Component V or ADP-CV1 cable) is needed for a component signal.*

### Computer 3 (RGB Digital)

Selects the computer connected to your COMPUTER 3 (DVI-D) connector.

### Component

Selects what is connected to your COMPONENT IN (Y, Cb/Pb, Cr/Pr).

### Video

Selects what is connected to your VIDEO input-VCR, laser disc player, DVD player or document camera.

### S-Video

Selects what is connected to your S-VIDEO input-VCR, DVD player, or laser disc player.

*NOTE: A frame may freeze for a brief period of time when a video is played back in fast-forward or fast-rewind with a Video or S-Video source.*

### Viewer

This feature enables you to make presentations using a PC card that contains captured images and slides created with the exclusive Ulead Photo Explorer 8.0 for NEC contained on the CD-ROM. See the supplied NEC Wired and Wireless Network Setup Guide for installing the Ulead Photo Explorer 8.0 for NEC.

See page 60 for viewing slides.

### LAN

Selects a signal from the LAN port (RJ-45) or the NEC optional wireless LAN card plugged into the projector's card slot.

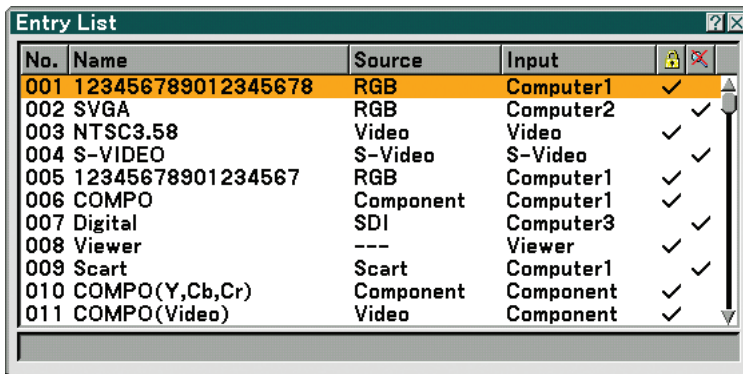
**[Entry List]**

No.	Name	Source	Input	
001	123456789012345678	RGB	Computer1	✓
002	SVGA	RGB	Computer2	✓
003	NTSC3.58	Video	Video	✓
004	S-VIDEO	S-Video	S-Video	✓
005	12345678901234567	RGB	Computer1	✓
006	COMPO	Component	Computer1	✓
007	Digital	SDI	Computer3	✓
008	Viewer	---	Viewer	✓
009	Scart	Scart	Computer1	✓
010	COMPO(Y,Cb,Cr)	Component	Component	✓
011	COMPO(Video)	Video	Component	✓

Use the SELECT ▲▼ buttons on your remote control or the projector cabinet to select the signal and press the ENTER button on the remote control or the projector cabinet to display the [Entry Edit Command] screen.

**Entering the Currently Projected Signal into the Entry List**

1. *Display the Entry List.*
2. *Use the SELECT ▲ or ▼ button on your remote control or the projector cabinet to select any number and press the ENTER button on the remote control or the projector cabinet to display the [Entry Edit Command] screen.*
3. *Use the SELECT ◀ or ▶ button to select [Store] and press the ENTER button.*

**Using the [Entry List]**

Making any adjustments to the current picture will automatically register its adjustments to the [Entry List]. The registered signal can be loaded any time from the [Entry List].

---

*NOTE: Up to 100 presets can be registered except settings on the Picture.*

---

[Entry Edit Command]



You can edit signals on the [Entry List].

- Load ..... Enables you to select a signal from the list.
- Store ..... Enables you to store the currently projected signal.
- Cut ..... Enables you to remove a selected signal from the list and place it on the "clipboard" in the projector.
- Copy ..... Enables you to copy a selected signal from the list and place it on the "clipboard" in the projector.
- Paste ..... Enables you to paste the signal placed on the "clipboard" to any other line of the list.
- Edit ..... Enables you to change source names.

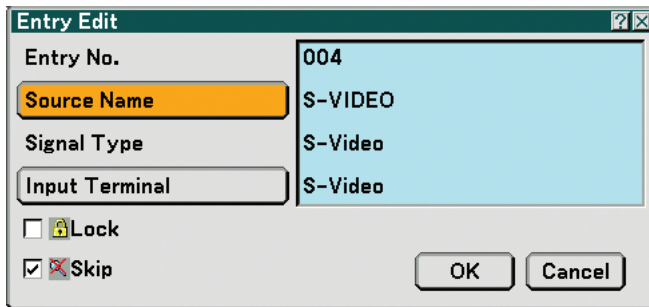

**Source Name:**

Enter a signal name. Up to 18 alphanumeric characters can be used.

**Input Terminal:**

Change the input terminal.

**Lock:**

Set so that the selected signal cannot be deleted when "All Delete" is executed. After executing [Lock], the changes cannot be saved.

**Skip:**

Set so that the selected signal will be skipped during auto search.

When complete, select OK and press ENTER. To exit without storing the setting, select Cancel. Select [Source Name] and press ENTER to display the Source Name Edit window. You can change source name on this window. Press ▼ to display the software keyboard, which you can enter alphanumeric characters. See page 128 for the key function of the software keyboard.

All Delete ..... This feature enables you to delete all the registered signals in the Entry List.

The following buttons are not available for the currently projecting signals:

- 1) The Cut and Paste buttons on the [Entry Edit Command] screen
- 2) The Input Terminal button on the [Entry Edit] screen

*NOTE: When all the signals in the [Entry List] are deleted, the currently projected signal will be also deleted except locked signals.*

## 5 Menu Descriptions & Functions [Adjust]

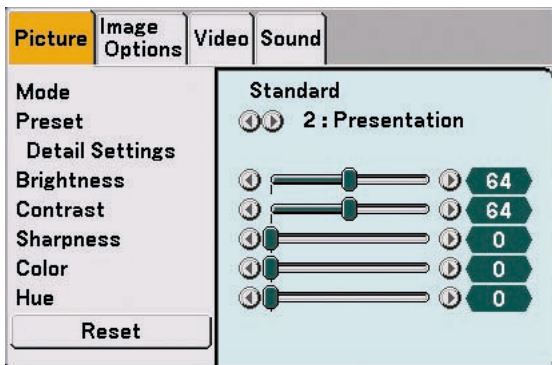

### [Picture]

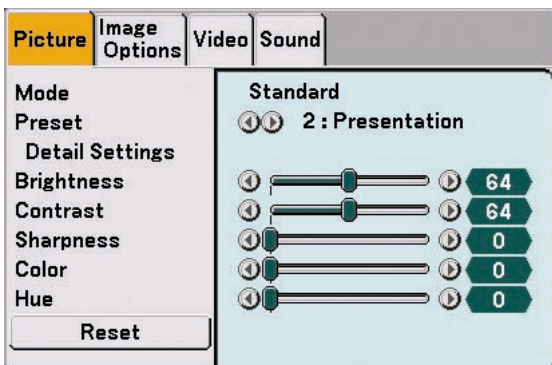

### [Mode]

This function allows you to determine how to save settings for [Detail Settings] of [Preset] for each input.

Standard : Saves settings for each item of [Preset] (Preset 1 through 6)

Professional : Saves all the settings of [Picture] for each input.

### [Preset]

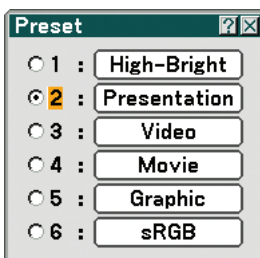

This option allows you to adjust neutral tint for yellow, cyan or magenta. There are six factory presets optimized for various types of images, you can set user adjustable settings.

### [Detail Settings]

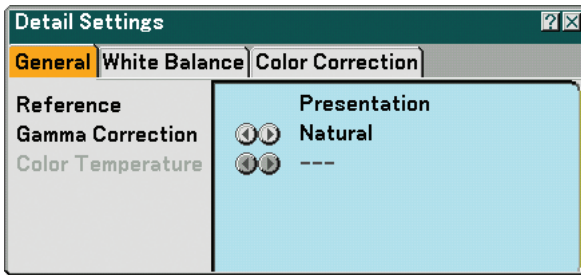

This will provide you with three pages of menus that provide more detailed settings.

#### [General]

##### Selecting Reference Setting [Reference]

This feature allows you to use color correction or gamma values as reference data to optimize for various types of images. You can select one of the following six settings.

- High-Bright ..... Recommended for the use in a brightly lit room.
- Presentation ..... Recommended for making a presentation using a PowerPoint file.
- Video ..... Recommended for regular picture such as TV program.
- Movie ..... Recommended for movies.
- Graphic ..... Recommended for graphics.
- sRGB ..... Standard color values.

##### Selecting Gamma Correction Mode [Gamma Correction]

Each mode is recommended for:

- Dynamic ..... Creates a high-contrast picture.
- Natural ..... Natural reproduction of the picture.
- Black Detail ..... Emphasizes detail in dark areas of the picture.

##### Adjusting Color Temperature [Color Temperature]

This feature adjusts the color temperature using the slide bar.

Increase the color temperature for more bluish white; decrease it for more reddish white.

---

#### NOTE:

- When [Presentation] or [High-Bright] is selected in [Reference], this function is not available.
  - When [White Balance] settings has been changed, the color temperature value on screen does not reflect the real color temperature.
- 

#### [White Balance]

##### Adjusting White Balance [White Balance]

This allows you to adjust the white balance. Brightness for each color (RGB) is used to adjust the black level of the screen; Contrast for each color (RGB) to adjust the white level of the screen.

#### [Color Correction]

##### Selecting Color Correction [Color Correction]

Adjusts red, green, blue, yellow, magenta and cyan each independently to correct the tint of the whole screen.

### [Brightness]

Adjusts the brightness level or the back raster intensity.

### [Contrast]

Adjusts the intensity of the image according to the incoming signal.  
You have two options: Manual and Auto.

---

*NOTE: The Auto Contrast function will not work when the menu or a message is displayed*

---

### [Sharpness]

Controls the detail of the image for Video (not valid for RGB and digital signals).

### [Color]

Increases or decreases the color saturation level (not valid for RGB and digital signals).

### [Hue]

Varies the color level from +/- green to +/-blue. The red level is used as reference. This adjustment is only valid for Video, Component and TV standard inputs (not valid for RGB and digital signals).

Input signal	Brightness	Contrast	Sharpness	Color	Hue
Computer (RGB analog)	Yes	Yes	No	No	No
Computer (RGB digital)	Yes	Yes	No	No	No
Component	Yes	Yes	Yes	Yes	Yes
Video, S-Video	Yes	Yes	Yes	Yes	Yes
Viewer, LAN	No	No	No	No	No

Yes=Adjustable, No=Not adjustable

### [Reset]

The settings and adjustments for [Picture] will be returned to the factory settings with the exception of the following; Preset numbers and [Reference] within the [Detail Settings] screen when [Standard] is selected in [Mode]. The settings and adjustments under [Detail Settings] within the [Preset] screen that are not currently selected will not be reset.



**[Image Options]**

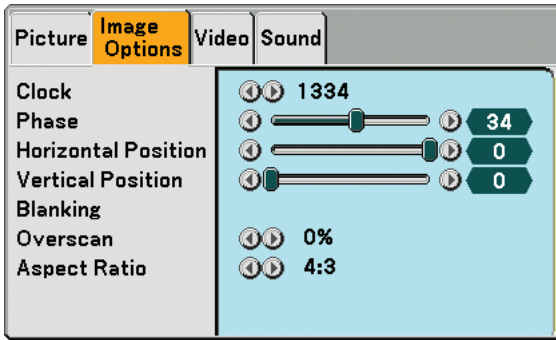

**Adjusting Clock and Phase [Clock/Phase]**

This allows you to manually adjust Clock and Phase.

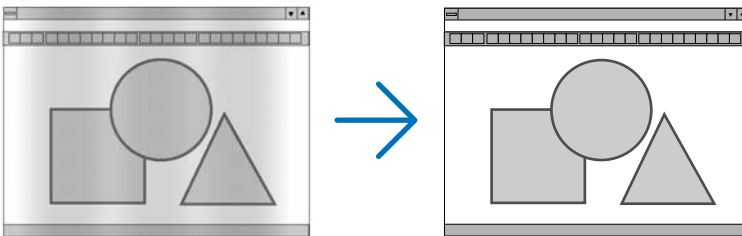

**Clock** ..... Use this item to fine tune the computer image or to remove any vertical banding that might appear. This function adjusts the clock frequencies that eliminate the horizontal banding in the image. This adjustment may be necessary when you connect your computer for the first time.

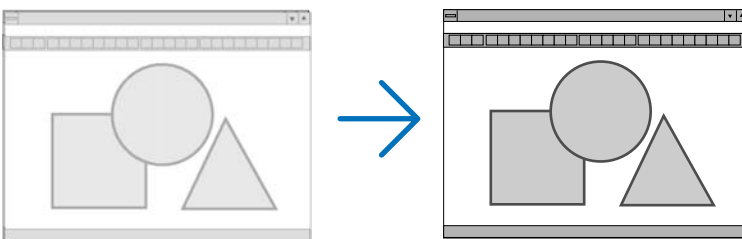

**Phase** ..... Use this item to adjust the clock phase or to reduce video noise, dot interference or cross talk. (This is evident when part of your image appears to be shimmering.) Use [Phase] only after the [Clock] is complete.

### Adjusting Horizontal/Vertical Position [Horizontal/Vertical Position]

Adjusts the image location horizontally and vertically.

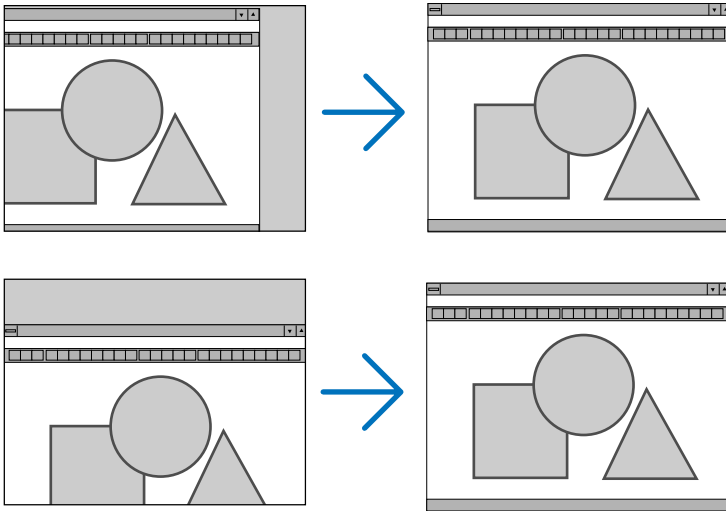

### Masking Unwanted Area [Blanking]

This feature allows you to mask any unwanted area of the screen image.

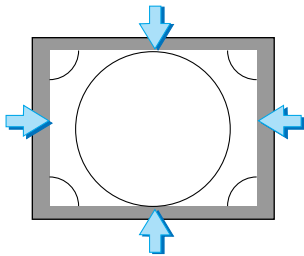

### Selecting Overscan Percentage [Overscan]

Select overscan percentage (0%, 5% and 10%) for signal.

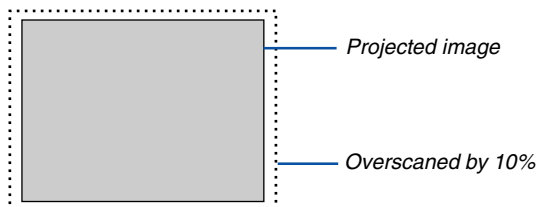

---

*NOTE: You cannot select [0%] for some input signals.*

---

Selecting Aspect Ratio [Aspect Ratio]

Screen Type 4:3

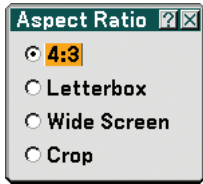

Screen Type 16:9

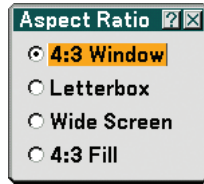

Aspect Ratio allows you to select the best Aspect mode to display your source image. When screen type 4:3 is selected for the source, the following selections will display:

- 4:3 ..... Standard 4:3 aspect
- Letter Box ..... Reduced to display the true aspect with black borders on top and bottom
- Wide Screen ..... Left & Right stretched with black borders on top and bottom
- Crop ..... Left & Right stretched. Left & Right sides cut. Available for 4:3 only.











When screen type 16:9 is selected for the source, the following selections will display:

- 4:3 Window ..... Reduced to display the true aspect with black borders on right and left
- Letter Box ..... Standard 16:9 aspect
- Wide Screen ..... Left and right stretched to display the true aspect
- 4:3 Fill ..... Stretched to display in 16:9 aspect ratio

*NOTE: You can adjust image position vertically for a source with black borders on top and bottom. (→ page 88)*

*NOTE: Please note that using this projector for the purpose of commercial gain or the attraction of public attention in a venue such as a coffee shop or hotel and employing compression or expansion of the screen image with a [Aspect Ratio] or [Screen] setting may raise concern about the infringement of copyrights which are protected by copyright law.*

*NOTE: During 3D Reform adjustment, [Aspect Ratio] may not be available. Should this happen, first reset the 3D Reform data and then do setting again. Second repeat the 3D Reform adjustment. Changing the aspect ratio can limit 3D Reform in its adjustable range.*

Input Signal Screen Type	 4:3	 Letterbox	 Squeeze
4:3 Screen	 4:3	 Letterbox	  Wide Screen    Crop
16:9 Screen	  4:3 Window    4:3 Fill	 Letterbox	 Wide Screen

**[Video]**

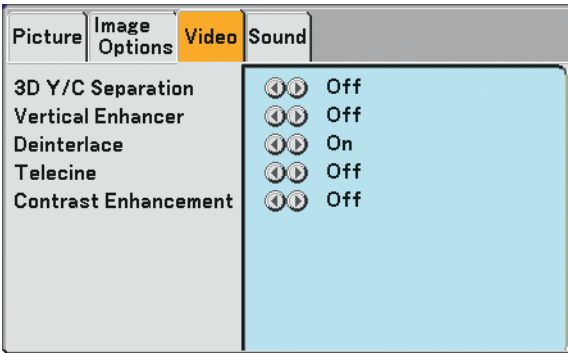

**Turning On/Off 3 Dimension Separation [3D Y/C Separation]**

This function turns on or off the 3 dimensional separation feature.

- Off ..... Turns off the function.
- On    Still ..... Recommended for a still image.
- Normal ..... The projector detects and corrects the image automatically.
- Movie ..... Recommended for a moving image.

***TIP:** When the image is poor quality, turn on [3D Y/C Separation]. If there is still poor quality, try turning off [Deinterlace] or try turning off [3D Y/C Separation] and select [Normal] in [Deinterlace].*

---

*NOTE: This feature is available for NTSC3.58 of Video signal only.*

---

**Setting Vertical Edges [Vertical Enhancer]**

This function enhances the vertical edges around objects in the image.

---

*NOTE: This function is not available for an RGB, HDTV and Component signal.*

---

**Selecting Interlace or Deinterlace [Deinterlace]**

This function allows you to select between "Interlace" and "Deinterlace".

- Off ..... Project the interlaced signal.
- On    Still ..... Select when a still image is displayed. When this option is selected for a moving image, jitter or artifacts can be seen.
- Normal ..... The projector automatically determines a still or moving image to display a clear picture. If selecting [Normal] causes excess jitter or artifacts, select [Movie].
- Movie ..... Select when a moving image is displayed. This will eliminate jitter and artifacts in a moving image. This option is available only for SDTV.

**Setting Telecine Mode [Telecine]**

Use 3:2 pull down correction to eliminate jitter and artifacts in video.

*NOTE: This feature is available only when [Deinterlace] is turned on and an SDTV signal is selected.*

- Off ..... Turns off the Telecine mode.
- On 2-2/2-3 Auto ..... Detects pull-down correction method.
- 2-2 On ..... Uses 2-2 pull-down correction method
- 2-3 On ..... Uses 2-3 pull-down correction method

**Setting Contrast Enhancement [Contrast Enhancement]**

This function provides improvement of contrast using a proprietary detail enhancement technology.

*NOTE: This function is not available for Viewer or LAN.*

- Off ..... Turns off the Contrast Enhancement mode.
- On ..... Turns on the Contrast Enhancement mode.
- Split ..... Turns on or off to show the effect of the Contrast Enhancement mode.
- Adjust ..... When the Contrast Enhancement mode is turned on or when [Split] is selected, you can adjust the Contrast Enhancement level.

**[Sound]**

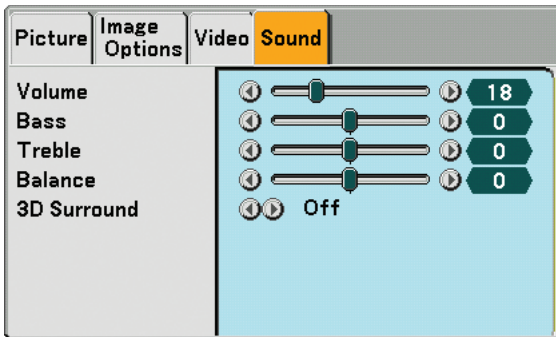

**Controlling Sound [Volume/Bass/Treble/Balance]**

Adjusts the volume, bass and treble level, left and right balance of the projector speaker and AUDIO OUT (Stereo Mini Jack).

**Enabling 3D Surround [3D Surround]**

Turn on or off the 3D surround effect.

If the AUDIO OUT stereo mini jack of the projector is connected to an external equipment, adjusting the sound on the external equipment can cause sound to be distorted or cracked, depending on the bass, treble or 3D Surround adjustment. If this happens, return the adjustments of the projector to the factory default (Bass:0, Treble: 0, 3D Surround: Off).

## ⑥ Menu Descriptions & Functions [Setup]

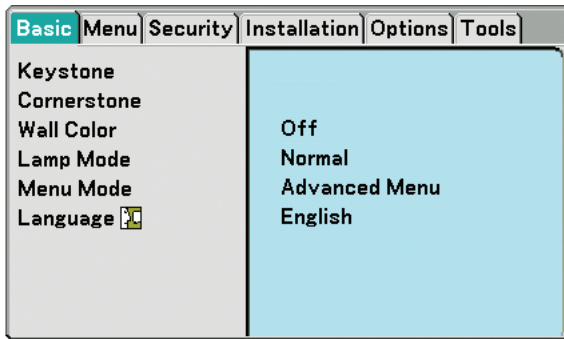

### [Basic]

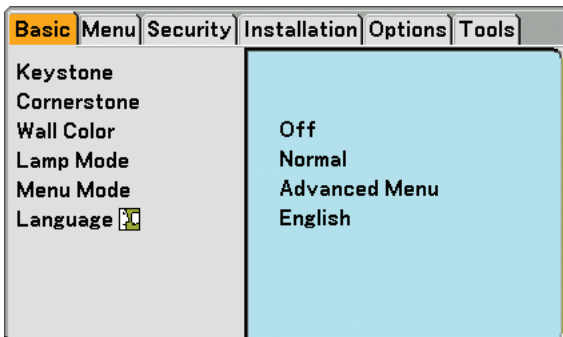

### Selecting Keystone Mode [Keystone]

This feature allows you to correct keystone distortion. Selecting this item will display the Keystone setting menu. You can correct vertical distortion manually from the menu. (→ page 31) Changes will be saved even when you turn off the projector.

*NOTE: When [Cornerstone] is selected, [Keystone] is not available.*

### Selecting Cornerstone Mode [Cornerstone]

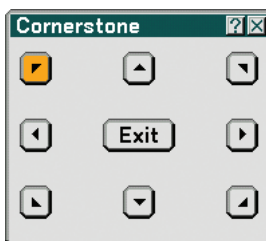

This option allows you to correct trapezoidal distortion. Selecting this item will display the Cornerstone adjustment screen. (→ page 41)

*NOTE: When [Keystone] is selected, [Cornerstone] is not available.*

**Using the Wall Color Correction [Wall Color]**

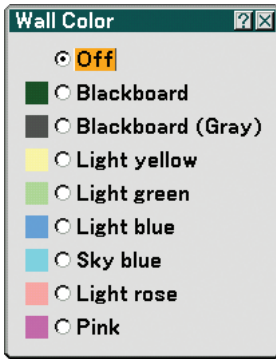

This function allows for quick adaptive color correction in applications where the screen material is not white. The following nine options are available.

**Setting Lamp Mode to Normal or Eco [Lamp Mode]**

This feature enables you to select two brightness modes of the lamp: Normal and Eco modes. The lamp life can be extended by using the Eco mode. Selecting Eco mode decreases fan noise compared to in Normal mode.

Lamp Mode	Description	Status of LAMP indicator
Normal Mode	This is the default setting (100% Brightness).	Off
Eco Mode	Select this mode to increase the lamp life (approx. 80% Brightness (light output) on NP2000 and approx. 85% Brightness (light output) on NP1000).	Steady Green light

*NOTE: If the projector is overheated in Normal mode, there may be a case where the Lamp mode will be forced into the Eco mode to protect the projector. This mode is called "forced Eco mode".  
 When the projector is in forced Eco mode, the picture brightness decreases. The LAMP indicator's steady green light indicates the lamp is in Eco mode.  
 When the projector comes back to normal temperature, the Lamp mode returns to Normal mode.  
 In the forced Eco mode, changing [Lamp mode] setting in the menu will not affect the actual lamp mode.*

**Selecting Menu Mode [Menu Mode]**

This feature allows you to select two menu modes: Basic Menu and Advanced Menu.

Basic Menu ..... This is the basic menu that contains minimum essentials of menus and commands.

Advanced Menu ..... This is the menu that contains all the available menus and commands.

**Selecting Menu Language [Language]**

You can choose one of 21 languages for on-screen instructions.

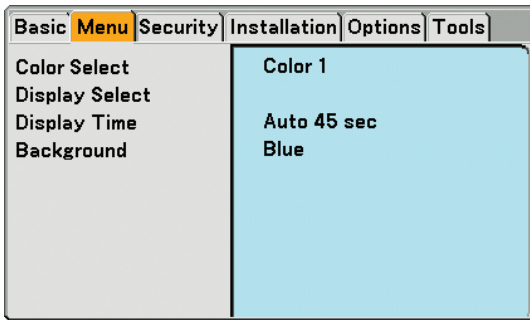
**[Menu]****Selecting Menu Color [Color Select]**

You can choose a color for the menu.

**Turning On / Off Source Display, Message and Time [Display Select]**

Source ..... This option turns on or off input name display such as Computer 1, Computer 2, Computer 3, Component, Video, and No Input to be displayed on the top right of the screen.

Message ..... This option turns on or off messages. Even though selecting [Off], the following message will appear.

- “Projector is locked” When the projector security is unlocked, the message will disappear.

Time ..... This option turns on or off the current time displayed on the top left of the screen.

*NOTE: The source and current time will be displayed for the time specified in [Display Time]. When [Manual] is selected in [Display Time], the source and current time will be always displayed.*

**Selecting Menu Display Time [Display Time]**

This option allows you to select how long the projector waits after the last touch of a button to turn off the menu. The preset choices are [Manual], [Auto 5 sec], [Auto 15 sec], and [Auto 45 sec]. The [Auto 45 sec] is the factory preset.

**Selecting a Color or Logo for Background [Background]**

Use this feature to display a blue/black screen or logo when no signal is available. The default background is blue. You can change the logo screen using the Viewer feature. (→ page 64)

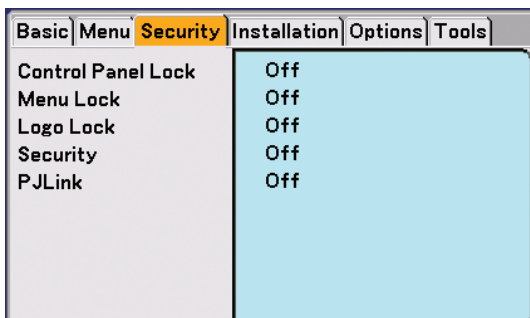
**[Security]****Disabling the Cabinet Buttons [Control Panel Lock]**

This option turns on or off the Control Panel Lock function.

**NOTE:**

- This Control Panel Lock does not affect the remote control functions.
- When the control panel is locked, pressing and holding the EXIT button on the projector cabinet for about 10 seconds will change the setting to [Off].



### Setting a Password [Menu Lock] / [Logo Lock]

A password can be set for your projector to avoid operation by an unauthorized person.

When [Menu Lock] is set, changing the menu from Basic to Advanced will display the Password input screen.

When [Logo Lock] is set, doing any one of the following two operations will display the Password input screen.

- Changing the background from or to [Logo]
- Changing the logo data in a PC card or USB memory.

#### [Entry]

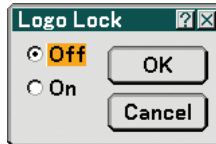
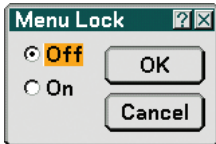

To assign your password:

---

*NOTE: Up to 15 alphanumeric characters can be assigned.*

---

#### 1. Type a password.

Select [On] and press the ENTER button.

The [Enter the Password] screen will be displayed.

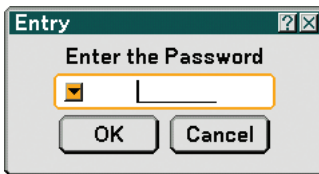

Make sure that  is highlighted and then press the ENTER button.

The Software keyboard appears. Use the Software keyboard to type a password and then highlight [OK] on the [Enter the Password] screen and press the ENTER button.

The [Confirm Password] screen will be displayed.

#### 2. Type the same password again. Highlight [OK] on the [Enter the Password] screen and press the ENTER button.

Your password will be assigned.

#### [Delete]

To delete your password:

#### 1. Select [Off] and press the ENTER button. The [Current Password] screen will be displayed.

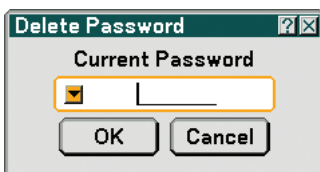

#### 2. Use the Software keyboard to type your password. Highlight [OK] on the [Current Password] screen and then press the ENTER button.

Your password will be deleted.

### [Security]

The Security function enables you to protect your projector so that the projector will not project a signal unless you enter a keyword. There is also an option to lock the projector by using a registered PC card\* or USB memory\* as a protect key. Once you have registered your PC card as a protect key, you are required to insert the registered PC card into the PC card slot of the projector each time you turn on the projector. You can enable the Security function by using a keyword only.

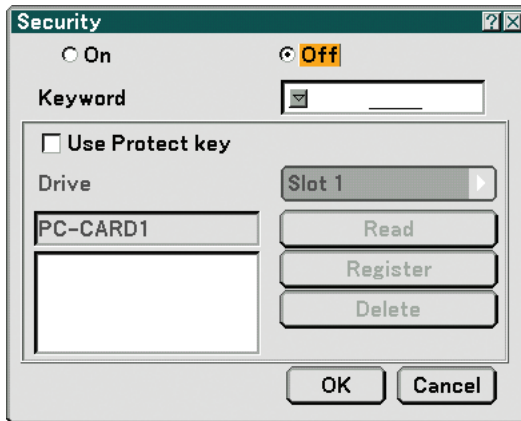

- \* The projector does not support NTFS formatted flash memory card or USB memory device. Be sure to use a flash memory card or USB memory device formatted with the FAT32, FAT16 or FAT file system. To format your flash memory card or USB memory device in your computer, refer to the document or help file that comes with your Windows.

On/Off ..... This turns the Security function on or off.

Keyword ..... Enter an appropriate keyword when you use the Security function. (Up to 10 characters can be used.) The Security function is available only when your keyword is entered.

Use Protect key ..... Check this box to lock your projector when using a PC card. To use a keyword without a PC card, do not check this box.

Drive ..... Switches between PC Card slot and USB port (type A).

Read ..... Reads data from a PC card.

Register ..... Registers data from the PC card. The Security function is not available unless at least one PC card is registered. (if the [Use Protect key] check box is selected) Up to 5 PC cards can be registered.

Delete ..... Deletes data of a registered PC card.

### To set up a keyword to enable the Security function without using a registered PC card.

1. Use the **SELECT ▲** or **▼** button to select [Keyword] and use the software keyboard to enter a keyword.

*NOTE: Please make a note of your keyword.*

2. Use the **SELECT ▲** or **▼** button to select [Off] and then use the **SELECT ◀** or **▶** to select [On].

3. Use the **SELECT ▲** or **▼** button to select [OK], then press the **ENTER** button.

The [Are you sure?] message will appear.

4. Use the **SELECT ◀** or **▶** button to select [Yes] and press the **ENTER** button.

The Security function takes effect.

### To register a PC card or USB memory device as a protect key.

**Preparation:** Insert the PC card into the PC card slot of the projector or insert the USB memory device into the USB port (type A) of the projector.

1. Use the **SELECT ▲** or **▼** button to select **[Use Protect Key]** and press the **ENTER** button.
2. Use the **SELECT ▲** or **▼** button to select **[Read]** and press the **ENTER** button.  
*Data of the PC card will be read into the projector.*
3. Use the **SELECT ▲** or **▼** button to select **[Register]** and press the **ENTER** button.  
*Downloaded data will be registered and be displayed in the list window.*
4. Use the **SELECT ▲** or **▼** button to select **[Keyword]** and use the software keyboard to enter a keyword.

---

*NOTE: Please make a note of your keyword.*

---

5. Use the **SELECT ▲** or **▼** button to select **[Off]** and then use the **SELECT ◀** or **▶** to select **[On]**.
6. Use the **SELECT ▲** or **▼** button to select **[OK]**, then press the **ENTER** button.  
*The [Are you sure?] message will appear.*
7. Use the **SELECT ◀** or **▶** button to select **[Yes]** and press the **ENTER** button.  
*The Security function takes effect.*

### To turn on the projector when Security is enabled (when using your keyword only).

1. Press and hold the **POWER** button for a minimum of two seconds.  
*The projector will be turned on and display a message to the effect that the projector is security-protected.*
2. Press the **MENU** button.  
*The Release Code input screen will be displayed.*
3. Enter your keyword in the Release Code input screen.  
*You can view the projected image.*

---

*NOTE: Do not forget your keyword. However, if you forget your keyword, NEC or your dealer will provide you with your Release Code. See more information at the end of this section.*

---

### To turn on the projector when Security is enabled (when using PC card or USB memory device as a protect key).

**Preparation:** Insert the registered PC card into the PC card slot of the projector or insert the registered USB memory device into the USB port (type A) of the projector.

Press and hold the **POWER** button for a minimum of two seconds.

The projector will turn on and then recognize the PC card or USB memory device. Once the image has been projected, it will stay on without the PC card or USB memory device.

- *The projector does not support NTFS formatted PC card or USB memory device.  
Be sure to use a PC card or USB memory device formatted with the FAT32, FAT16 or FAT file system.  
To format your PC card or USB memory device in your computer, refer to the document or help file that comes with your Windows.*
- *When the projector is turned on, if the registered PC card or USB memory device is not inserted into the projector, no signal will be displayed with a message to the effect that the projector is security-protected. To turn off the security protection, insert the registered PC card or USB memory device into the projector.*

- The security disable mode is maintained until the main power is turned off (by setting the main power switch to "O" or unplugging the power cord). In the following cases you will be asked to check the protect key or input the keyword:
  - (1) When [OK] is selected at an image for which security is set and the power is turned off then back on
  - (2) When the main power is turned off then back on while the security function is enabled
  - (3) When you attempt to display an image for which security is set while the security function is enabled
- Blanks (spaces) cannot be used in the Keyword section.

### To delete PC card data you registered.

1. Use the **SELECT ▲** or **▼** button to select [Delete] and use the **SELECT ◀** button to select the list window.
2. Use the **SELECT ▲** or **▼** button to select the information on the PC card or USB memory device you wish to delete.
3. Press the **SELECT ►** button to select [Delete] and press the **ENTER** button.

The information on the PC card or USB memory device will be deleted.

### If you've lost your registered PC card, proceed as follows:

1. Press and hold the **POWER** button for a minimum of two seconds.  
*The projector will be turned on and display a message to the effect that the projector is security-protected.*
2. Press the **MENU** button.  
*The Release Code input screen will be displayed as well as your Request Code (24 alphanumeric characters).*

---

*NOTE: NEC or your dealer will provide you with your Release Code in exchange for your registered keyword and Request Code. See more information at the end of this section.*

---

3. Enter your Release Code in the Release Code Input screen.  
*The security protection will be turned off.*

---

#### **NOTE:**

- Some brands of PC cards or USB memory devices cannot be used as a protect key.
  - You should register one or more PC cards or USB memory devices in case your registered PC card or USB memory device is damaged or stolen. Up to 5 pieces can be registered.
  - Once the registered PC card or USB memory device has been formatted, the PC card or USB memory device cannot be recognized as your registered protect key.
- 

The Security will not be disabled by using [Reset].

---

#### **NOTE:**

For additional information visit:

US : <http://www.necdisplay.com/>

Europe : <http://www.nec-display-solutions.com/>

Global : <http://www.nec-pj.com/>

---

### Using PJLink

This option allows you to set a password when you use the PJLink feature.

On/Off: Enable or disable the password.

Password: Enter a password (up to 32 characters)

*NOTE: What is PJLink?*

*PJLink is a standardization of protocol used for controlling projectors of different manufacturers. This standard protocol is established by Japan Business Machine and Information System Industries Association (JBMIA) in 2005.*

*The projector supports all the commands of PJLink Class 1.*

Setting of PJLink will not be affected even when [Reset] is done from the menu.

### [Installation]

Basic	Menu	Security	Installation	Options	Tools
Orientation			Desktop Front		
Screen			4:3		
LAN Mode					
Projector Name			NP2000 Series		
Communication Speed			38400bps		
Date, Time Preset					
Remote Sensor			Front/Back		

### Selecting Projector Orientation [Orientation]

This reorients your image for your type of projection. The options are: desktop front projection, ceiling rear projection, desktop rear projection, and ceiling front projection.

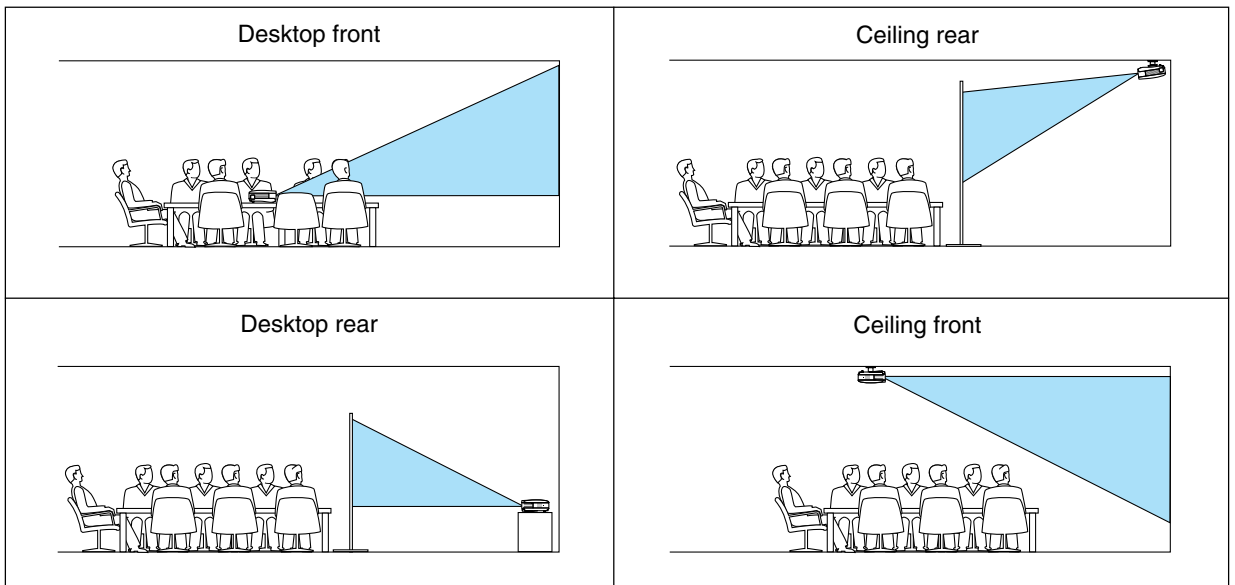

### Selecting Aspect Ratio and Position for Screen [Screen]

Screen Type ..... Select one of two options: 4:3 Screen or 16:9 Screen for the screen to be used. See also [Aspect Ratio].  
(→ page 77)

Position ..... This feature allows you to adjust the vertical position of the image when 16:9 has been selected for the screen type.

When 16:9 has been selected there is black area above and below the image.

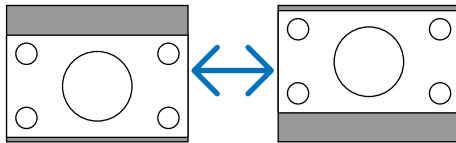

---

*NOTE: This option is available only when [16:9] is selected in [Screen Type].*

---

**NOTE:**

- After changing the screen type, check the setting of [Aspect Ratio] in the menu. (→ page 77)
  - [Position] is not available when [4:3] is selected for [Screen Type] or when [Letter Box] is selected for [Aspect Ratio].
  - During [Keystone] or [Cornerstone] adjustment, [Screen Type] or [Position] is not available. To make available, first reset the adjustments for [Keystone] or [Cornerstone] and then make settings for [Screen Type] or [Position]. Finally make adjustments for [Keystone] or [Cornerstone] again. Changing [Screen Type] or [Position] may limit [Keystone] or [Cornerstone] in its adjustable range.
-

### [LAN Mode]

#### Setting LAN Mode

This feature allows you to set various setting items when the projector is used on your network.

#### CAUTION

- Consult with your network administrator about these settings.
- Connect a LAN cable (Ethernet cable) to the LAN port (RJ-45). (→ page 19)
- For wireless LAN connection, use the NEC optional wireless LAN card (NWL-100\*).
  - \* Last digit of the model code varies depending on which country you live in. For more information, visit our Website.
- To use wireless LAN, insert the NEC optional wireless LAN card (NWL-100\*) into the PC Card slot.  
(→ "Inserting and Removing a PC Card" on page 21)

#### Hints on How to Set Up LAN Connection

To configure the projector to communicate on the network using the LAN port (RJ-45) or the optional wireless LAN card:

1. **Select the [Built-in] tab for the LAN port (RJ-45) or the [PC Card] tab for the optional wireless LAN card.**
2. **On the [Built-in] tab or the [PC Card] tab, select a number from the [Profiles] list for your LAN settings. Two settings can be stored in memory for each the LAN port and the wireless LAN card respectively.**
3. **On the [Built-in] tab or the [PC Card] tab, turn on or off [DHCP], specify IP address, Subnet Mask, Gateway and DNS Configuration. Select [OK] and press the ENTER button.**  
(→ page 90, 91)

To recall the settings from memory:

After selecting the [Built-in] tab or the [PC Card] tab, select the number from the [Profiles] list. Select [OK] and press the ENTER button. (→ page 90, 91)

To connect a DHCP server:

On the [Built-in] tab or the [PC Card] tab, select [DHCP] and press the ENTER button. A check mark will be placed. Select again and press the ENTER button. The check box will be cleared.

When setting an IP address without using a DHCP server, clear the check box for [DHCP]. (→ page 90, 91)

To set only for wireless LAN (Network Type and WEP):

1. **On the [PC Card] tab, select [Profiles] and then select [Profile 1] or [Profile 2].**
2. **On the [PC Card] tab, select [Advanced] and press the ENTER button. The [Advanced] menu will be displayed.**  
(→ page 92, 93)

To select a wireless LAN access point:

1. **On the [PC Card] tab, select [Profiles] and then select [Profile 1] or [Profile 2].**
2. **On the [PC Card] tab, select [Advanced] and press the ENTER button.**
3. **On the Advanced menu, select [Network Type] → [Site Survey] and press the ENTER button.**
4. **Select [Mode] and then select [Infrastructure].**  
(→ page 92)

To receive error messages or information on the remaining lamp life via e-mail:

1. **On the [Mail] tab, select [Alert Mail] and press the ENTER button. A check mark will be placed.**
2. **Set [Sender's Address], [SMTP Server Name] and [Recipient's Address]. Select [OK] and press the ENTER button.**

(→ page 95)

To execute [Easy Connection] using Image Express Utility 2.0:

The [Easy Connection] is a mode that can abbreviate the troublesome LAN settings when using the Image Express Utility 2.0 and connecting the PC and projector via a wireless LAN.

The Image Express Utility 2.0 is contained on the supplied User Supportware 3 CD-ROM. To use [Easy Connection], select [PC Card] → [Profiles] → [Easy Connection]. (→ page 91)

### [Built-in]

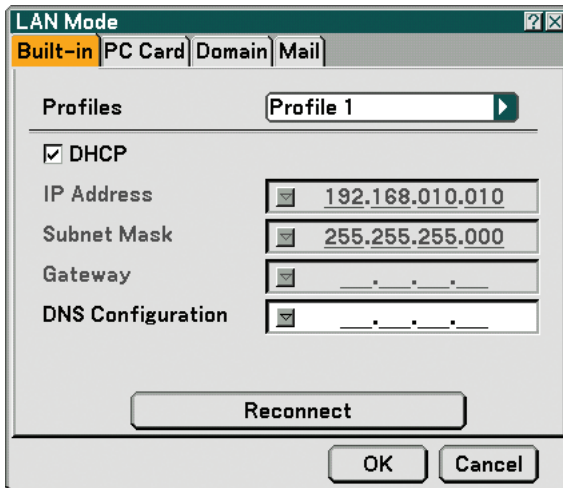

Profiles (for LAN port [RJ-45]):

Up to two settings for the LAN port (RJ-45) can be stored in memory of the projector.

Select [Profile 1] or [Profile 2] and then do settings for [DHCP] and the other options.

After doing this, select [OK] and press the ENTER button. This will store your settings in memory.

### DHCP:

Enabling this option automatically assigns an IP address to the projector from your DHCP server.

Disabling this option allows you to register the IP address or subnet mask number obtained from your network administrator.

IP Address ..... Set your IP address. Press  to display the software keyboard and type in 12 numeric characters.

Subnet Mask ..... Set your subnet mask number. Press  to display the software keyboard and type in 12 numeric characters.

Gateway ..... Set the default gateway of the network connected to the projector. Press  to display the software keyboard and type in 12 numeric characters.

DNS Configuration Type in the IP address of DNS server on the network connected to the projector. 12 numeric characters are used.

Reconnect ..... Use this button to connect the projector to a network.



[PC Card]

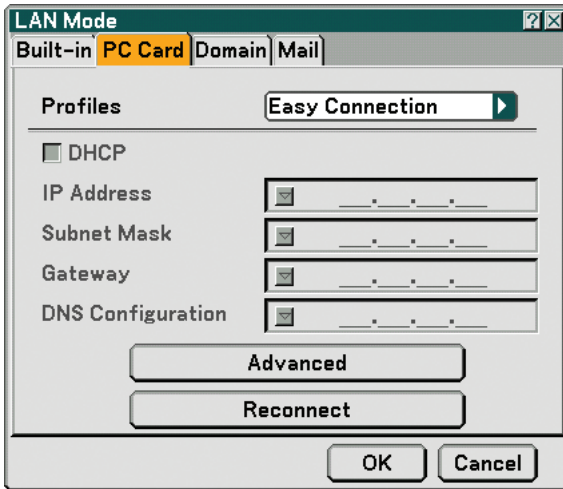

Profiles (for PC Card):

To execute a wireless LAN easily using Image Express Utility 2.0, select [Easy Connection].

Up to two settings for the optional wireless LAN card can be stored in memory of the projector.

Select [Profile 1] or [Profile 2] and then do settings for [DHCP] and the other options.

After doing this, select [OK] and press the ENTER button. This will store your settings in memory.

DHCP:

Place a check mark to automatically assign an IP address to the projector from your DHCP server.

Clear this check box to register the IP address or subnet mask number obtained from your network administrator.

IP Address ..... Set your IP address. Press to display the software keyboard and type in 12 numeric characters.

Subnet Mask ..... Set your subnet mask number. Press to display the software keyboard and type in 12 numeric characters.

Gateway ..... Set the default gateway of the network connected to the projector. Press to display the software keyboard and type in 12 numeric characters.

DNS Configuration Type in the IP address of DNS server on the network connected to the projector. Twelve numeric characters are used.

Advanced ..... Displays the Advanced menu which includes various setting for wireless LAN connection (Network Type and WEP). See the Advanced menu later on.

Reconnect ..... Use this button to connect the projector to a network.

[Advanced] menu  
 [Network Type] (required for wireless only)

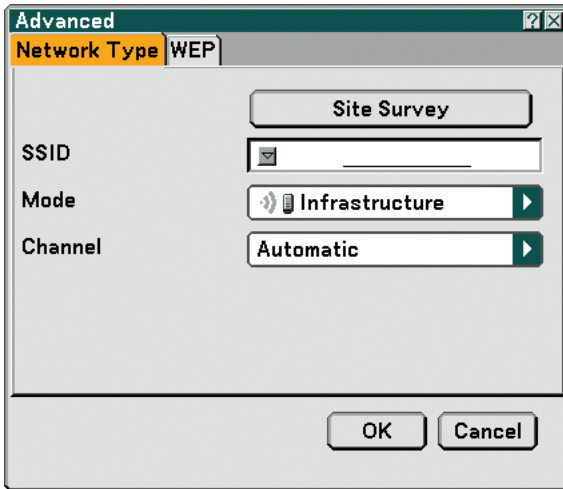

Site Survey:

Displays a list of available SSIDs for wireless LAN on site. Select an SSID which you can access.

To select an SSID, highlight [SSID] and use the SELECT ► to select [OK] and press the ENTER button.

- 📶 : access point
- 📶🖥️ : Ad Hoc PC
- 🔑 : WEP enabled

NOTE: You cannot connect to a device with the SSID for Channel 14 because it is not displayed in the list.

SSID (Network name):

Enter an identifier (SSID) for wireless LAN when selecting [Infrastructure] or [802.11 Ad Hoc] in [Mode]. Communication can be done only with equipment whose SSID matches SSID for your wireless LAN. Up to 32 alphanumeric characters can be used (case sensitive).

Mode:

Select communication method when using wireless LAN.

Infrastructure ..... Select this option when communicating with one or more equipment connected to the wireless or wired LAN network via an access point.

802.11 Ad Hoc ..... Select this option when using the wireless LAN to directly communicate with a computer in peer-to-peer mode. This is a method that meets the IEEE802.11 wireless standard.

---

*NOTE: When in Ad Hoc mode, only 802.11b is available for communication method.  
 Data transmission speed in Ad Hoc mode is limited up to 11Mbps.*

---

Channel:

Select a channel. There are 14 options available.

[WEP] (required for wireless only)

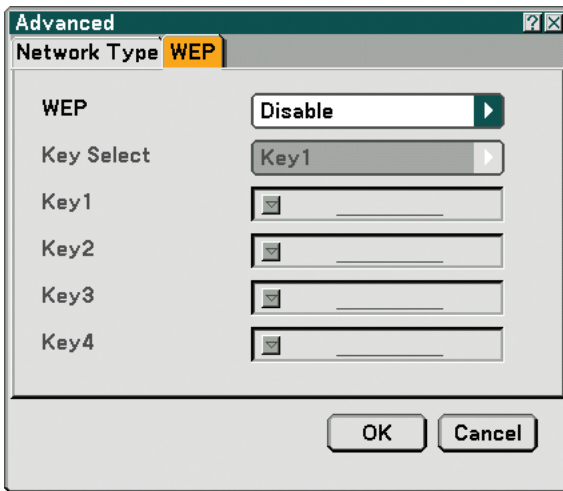

Select this option whether using the WEP (Wired Equivalent Privacy) key for encryption or not. To use encryption, specify WEP key.

Disable ..... Will not turn on the encryption feature. Your communications may be monitored by someone.

64bit ..... Uses 64-bit datalength for secure transmission.

128bit ..... Uses 128-bit datalength for secure transmission. This option will increase privacy and security when compared to use of 64-bit datalength encryption.

152bit ..... Uses 152-bit datalength for secure transmission. This option will increase privacy and security when compared to use of 128-bit datalength encryption.

**NOTE:**

- The WEP settings must be the same as communication devices such as PC or access point in your wireless network.
- When you use WEP, your image transmission speed will slow down.

**Key Select:**

Selects one key from the four keys below when selecting [64bit], [128bit] or [152bit] in [WEP].

**Key1-4:**

Enter encryption key when selecting [64bit], [128bit] or [152bit] in [WEP].

Up to 5 characters can be set in 64 bit, up to 13 characters in 128 bit and up to 16 characters in 152 bit. Press the [HEX] button to change to [ASCII] to set the key in ASCII digit. You can toggle this button between [ASCII] and [HEX].

The key can also be set in hexadecimal digit.

\* Enter 0x(numeral and alphabet respectively) right in front of your key code.

\* Hexadecimal uses 0 to 9 and A to F.

\* When setting in a hexadecimal digit, up to 10 characters can be set in 64 bit, up to 26 characters in 128 bit and up to 32 characters in 152 bit.

### Using Software Keyboard to enter an encryption key

1. Select one of [Key 1], [Key 2], [Key 3] and [Key 4] and press the ENTER button.  
The software keyboard will be displayed.

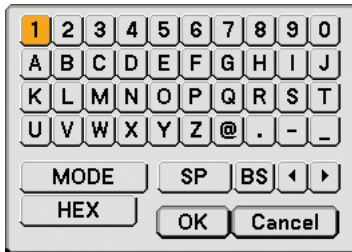

2. Use the SELECT ▲▼◀▶ button to select one key and press the ENTER button.
3. After finishing entering the WEP key, use the SELECT ▲▼◀▶ button to select [OK] and press the ENTER button.  
The software keyboard will disappear.

[Domain]

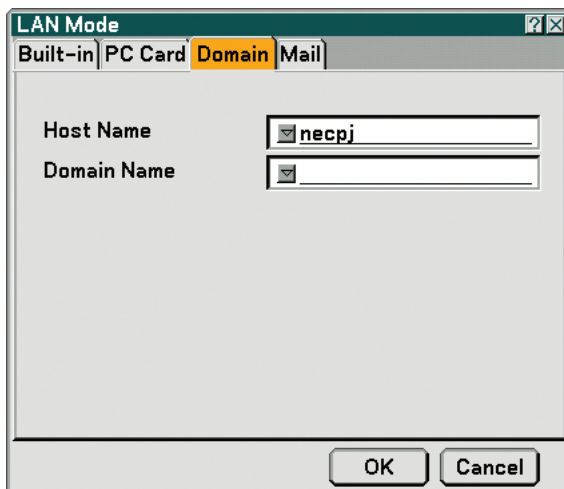

Host Name ..... Type in a hostname. Up to 60 alphanumeric characters can be used.

Domain Name ..... Type in domain name of the network connected to the projector. Up to 60 alphanumeric characters can be used.

## [Mail]

The screenshot shows a window titled "LAN Mode" with four tabs: "Built-in", "PC Card", "Domain", and "Mail". The "Mail" tab is active. Inside the window, there is a checkbox labeled "Alert Mail". Below it are five input fields, each with a dropdown arrow on the left: "Sender's Address", "SMTP Server Name", "Recipient's Address 1", "Recipient's Address 2", and "Recipient's Address 3". A "Test Mail" button is positioned below these fields. At the bottom of the window are "OK" and "Cancel" buttons.

**Alert Mail:**

Checking this box enables Alert Mail feature.

This option notifies your computer of an error message via e-mail when using wireless or wired LAN. The error message will be notified when the projector lamp has reached the end of its usable life or an error occurs in the projector.

Sample of a message sent from the projector:

*The lamp is at the end of its usable life. Please replace the lamp.*

*Projector Name: X X X X*

*Lamp Hours Used: xxxx [H]*

*Projector Hours Used: xxxxxx [H]*

**Sender's Address:**

Specify the senders address. Use the Software keyboard. Up to 60 alphanumeric and symbols characters can be used. See "Using Software Keyboard" in Appendix for more details.

**SMTP Server Name:**

Type in the SMTP server name to be connected to the projector. Up to 60 alphanumeric characters can be used.

**Recipient's Address 1 to 3:**

Type in your recipient's address. Up to 60 alphanumeric and symbols characters can be used.

**Test Mail:**

Send a test mail to check if your settings are correct.

**NOTE:**

- If you entered an incorrect address in a test, you may not receive an Alert mail. Should this happen, check if the Recipient's Address is correctly set.
- Unless any one of the [Sender's Address], [SMTP Server's Name] or [Recipient's Address 1-3] is selected, [Test Mail] is not available.
- Be sure to highlight [OK] and press the ENTER button before executing [Test Mail].

---

**NOTE:** To use the Mail Alert feature on wireless LAN connection, select [Infrastructure] for [Mode] in [Network Type].

---

### [Projector Name]

Specify a unique projector name. Press  to display the software keyboard and type in. Up to 16 alphanumeric characters can be used. After entering a name, select [OK] and press the ENTER button.

#### Using Software Keyboard

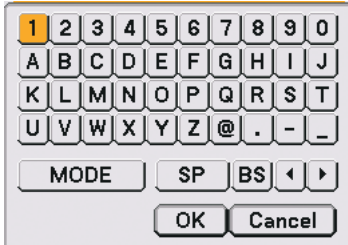

1 to 0 and

Characters ..... Use to type in password or keyword.

MODE ..... Selects one of three modes for alphabet and special characters.

SP ..... Inserts a space

BS ..... Deletes one character backward

◀ ..... Returns to the previous

▶ ..... Advances to the next

OK ..... Executes the selection

Cancel ..... Cancels the selection

### Selecting Communication Speed [Communication Speed]

This feature sets the baud rate of the PC Control port (D-Sub 9 Pin). It supports data rates from 4800 to 38400 bps. The default is 38400 bps. Select the appropriate baud rate for your equipment to be connected (depending on the equipment, a lower baud rate may be recommended for long cable runs).

Your selected communication speed will not be affected even when [Reset] is done from the menu.

### Setting the Current Date and Time [Date, Time Preset]

You can set the current time, month, date, and year.

---

*NOTE: The projector has a built-in clock. The clock will keep working for about 2 weeks after the main power is turned off. If the main power is off for 2 weeks or more, the built-in clock will cease. If the built-in clock ceases, set the date and time again. The built-in clock will not cease while in the standby mode.*

---

### Turning On or Off Remote Sensor [Remote Sensor]

This option determines which remote sensor on the projector is enabled in wireless mode.

The options are: front, rear or both.

**[Options]**

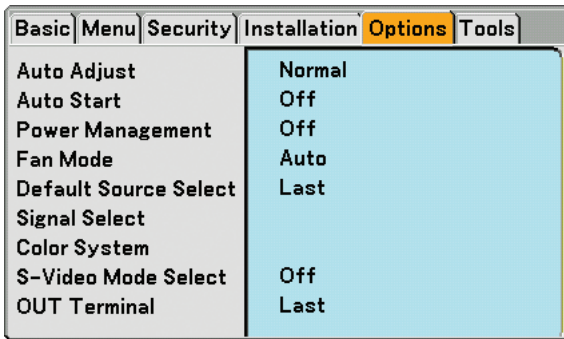

**Setting Auto Adjust [Auto Adjust]**

This feature sets the Auto Adjust mode so that the RGB image can be automatically or manually adjusted for noise and stability. You can automatically make adjustment in two ways: [Normal] and [Fine].

- Off ..... The RGB image will not be automatically adjusted.  
You can manually optimize the RGB image.
- Normal ..... Default setting. The RGB image will be automatically adjusted. Normally select this option.
- Fine ..... Select this option if fine adjustment is needed. It takes more time to switch to the source than when [Normal] is selected.

**Enabling Auto Start [Auto Start]**

Turns the projector on automatically when the power cable is inserted into an active power outlet and the main power switch is turned on. This eliminates the need to always use the POWER (ON/STANDBY) button on the remote control or projector cabinet.

To use the Auto Start function, you must first press the main power switch to the position "On" before plugging the power cable.

**Enabling Power Management [Power Management]**

When this option is selected you can enable the projector to automatically turn off (at the selected time: 5min., 10min., 20min., 30min.) if there is no signal received by any input.

**Enabling High Speed Fan Mode [Fan Mode]**

This option allows you to select two modes for fan speed: Auto mode and High speed mode.

- Auto ..... The built-in fans automatically run at a variable speed according to the internal temperature.
- High ..... The built-in fans run at high speed.

When you wish to cool down the temperature inside the projector quickly, select [High].

---

*NOTE: Select High mode if you continue to use the projector for consecutive days.*

---

**Selecting Default Source [Default Source Select]**

You can set the projector to default to any one of its inputs each time the projector is turned on.

- Last ..... Sets the projector to default to the previous or last active input each time the projector is turned on.
- Auto ..... Searches for an active source in order of Computer1 → Computer2 → Computer3 → Component → Video → S-Video → Viewer → Computer1 and displays the first found source.
- Select ..... Displays the selected source input every time the projector is started up. Select an input from the pull-down menu.

### Selecting Signal Format [Signal Select]

#### Computer 1/2

Allows you to set [Computer 1] and [Computer 2] to automatically detect an incoming RGB or component source such as a computer or DVD player. However there may be some RGB and component signals that the projector is unable to detect. In this case, select [RGB] or [Component].

Select [Scart] in COMPUTER 1 for the European Scart signal.

#### Component

Select a signal type from the COMPONENT (Y, Cb/Pb, Cr/Pr) connectors.

Component..... Selects a component signal.

Video ..... Selects a component signal such as Y/Cb/Cr or Y/Pb/Pr.

---

*NOTE: When using the "Y" connector of the COMPONENT connectors to display a Video signal, select "Video".*

---

### Selecting [Color System]

This feature enables you to select video standards manually.

Normally select [Auto]. Select the video standard from the pull-down menu. This must be done for Component (Video), Video and S-Video Connector separately.

### Selecting S-Video Mode [S-Video Mode Select]

This feature is used to select the S-Video signal detection mode.

This allows identifying of the S-Video signals with different aspect ratio (16:9 and 4:3).

Off ..... Does not identify any S-Video signal.

S2 ..... Identifies the 16:9 or 4:3 signal.

---

*NOTE: The Aspect Ratio is not available when S2 signal is detected.*

---

### Setting MONITOR OUT Connector [OUT Terminal]

This option allows you to determine which RGB or component source is output from the MONITOR OUT connector during Standby mode.

Last ..... The signal from the last COMPUTER 1, COMPUTER 2 or COMPONENT input will be output to the MONITOR OUT connector.

Computer 1, 2 ..... The signal from the COMPUTER1 or COMPUTER2 input will be output to the MONITOR OUT connector.

Component..... The signal from the COMPONENT input will be output to the MONITOR OUT connectors.

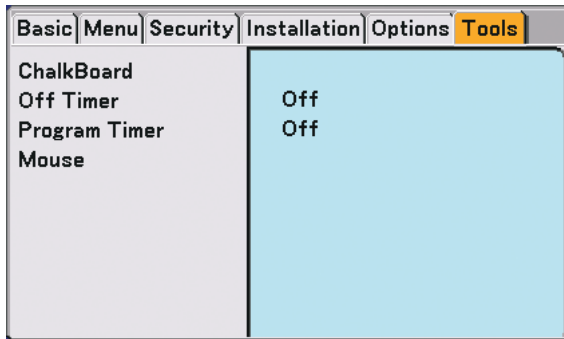

**[Tools]****Selecting the ChalkBoard [ChalkBoard]**

This option displays the ChalkBoard tool bar.

The ChalkBoard feature allows you to write and draw messages on a projected image. (→ page 44)

---

*NOTE: The ChalkBoard feature is available only when a USB mouse is used.*

---

**Using Off Timer [Off Timer]**

1. Select your desired time between 30 minutes and 16 hours: Off, 0:30, 1:00, 2:00, 4:00, 8:00, 12:00, 16:00.
2. Select [OK] and press the ENTER button on the remote control.
3. The remaining time starts counting down.
4. The projector will turn off after the countdown is complete.

---

*NOTE:*

- To cancel the preset time, set [Off] for the preset time or turn off the power.
  - When the remaining time reaches 3 minutes before the projector is turned off, the [The projector will turn off within 3 minutes] message will be displayed on the bottom of the screen.
- 

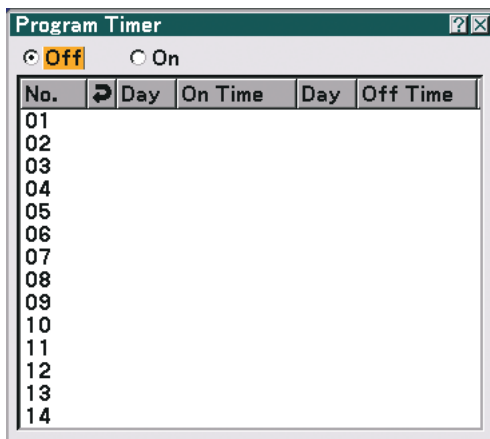
**Using Program Timer [Program Timer]**

This option turns on or off the projector automatically at a specified time. Up to 14 different timer settings can be programmed.

**NOTE:**

- Before setting the Program Timer, make sure that the [Date, Time Preset] feature is set. (→ page 96)
- Make sure that the projector is in the stand by condition with the Main Power Switch on.
- The projector has a built-in clock. The clock will keep working for about two weeks after the main power is turned off. If the main power is not supplied to the projector for two weeks or more, the built-in clock stops working.

### Setting the Program Timer

1. On the Program Timer screen, use the SELECT ▲ or ▼ button to select a program number (No. 1 to 14) and press the ENTER button.

The [Edit] screen will be displayed.

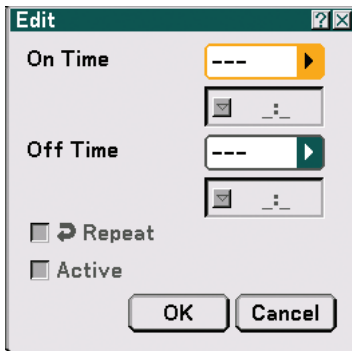

2. Set the turn-on time.

- 2-1. Use the SELECT ▲ or ▼ button to select --- (the day of week) for [On Time] and press the SELECT ► button or OK button.

The day of week pull-down list will be displayed.

- 2-2. Select a day of the week and press the ENTER button.

- 2-3. Use the SELECT ▲ or ▼ button to select --- (the time) for [On Time] and enter time.

- Enter time in 24-hour format

Example: Enter "06" to set 6:00 A.M. and "18" to set 6:00 P.M.

3. Set the turn-off time.

- 3-1. Use the SELECT ▲ or ▼ button to select --- (the day of week) for [Off Time] and press the SELECT ► button or OK button.

The day of week pull-down list will be displayed.

- 3-2. Select a day of the week and press the ENTER button.

- 3-3. Use the SELECT ▲ or ▼ button to select --- (the time) for [Off Time] and enter time.

- Enter time in 24-hour format

Example: Enter "06" to set 6:00 A.M. and "18" to set 6:00 P.M.

4. Set the Repeat option.

- To repeat the setting in weekly basis, use the SELECT ▲ or ▼ button to select the [Repeat] check box and press the ENTER button.

A check mark will be placed in the [Repeat] check box.

---

**NOTE:** To use the setting this week only, do not place a check mark in the [Repeat] check box.

---

### 5. Set the Active option.

- Use the **SELECT ▲** or **▼** button to select [Active] and press the **ENTER** button.  
A check mark will be placed in [Active].

### 6. Complete the settings.

- Use the **SELECT ▲** or **▼** button to select the [OK] button and press the **ENTER** button.  
On- time or off-time will be set.  
You will be returned to the Program Timer screen.

### Activating the Program Timer

On the Program Timer screen, select [On].

This will activate the time settings.

Selecting [Off] will disable the Program Timer even when a check mark is placed in the [Active] check box of the Edit screen.

---

#### NOTE:

- The Program Timer is executed on a set time basis, not on a program basis.  
When one or more active on- and off-time are set, the earlier time setting will take preference.
  - The off-timer programs not marked with a check in the [Repeat] check box will be disabled and the check mark in the [Active] check box will be cleared.  
The on-timer programs not marked with a check in the [Repeat] check box will be disabled and the check mark in the [Active] check box will be cleared.
  - When on-time and off-time are set for the same time, the off-time setting will take preference.
  - The on-time setting will not be executed while the cooling fans are running or an error is occurring.
  - If the off-time setting is expired in condition in which the power off is not possible, the off-timer setting will be executed in condition in which the power off is possible.
  - Programs with [On] selected on the [Edit] screen will not be executed even if the Program Timer is enabled.
- 

### Changing the programmed settings

#### 1. On the Program Timer screen, use the **SELECT ▲** or **▼** button to select a program you want to edit and press the **ENTER** button.

- The [Command] screen will be displayed.

#### 2. Select the [Edit] button and press the **ENTER** button.

The [Edit] screen will be displayed.

#### 3. Change the settings.

#### 4. Use the **SELECT ▲** or **▼** button to select the [OK] button and press the **ENTER** button.

The programmed settings will be changed.

You will be returned to the Program Timer screen.

### Delete the programmed settings

1. **On the Program Timer screen, use the SELECT ▲ or ▼ button to select a program you want to delete and press the ENTER button.**

- *The [Command] screen will be displayed.*

2. **Use the SELECT ▲ or ▼ button to select the [Delete] button and press the ENTER button.**

- *The programmed setting will be deleted.  
You will be returned to the Program Timer screen.*

### Setting Mouse Pointer, Button and Sensitivity [Mouse]

This option lets you to change your USB mouse settings. The mouse settings feature is available for USB mouse only. Choose the settings you want:

Mouse Pointer ..... Pointer 1 - 9

Mouse Button ..... [Right Hand] or [Left Hand]

Mouse Sensitivity .. [Fast], [Medium] or [Slow]

## 7 Menu Descriptions & Functions [Information]

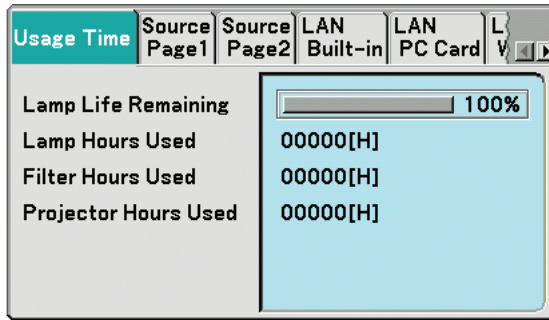

Displays the lamp and the projector usage hours, the status of the current signal and settings and LAN settings. This dialog box has seven pages.

The information included are as follows:

### [Usage Time]

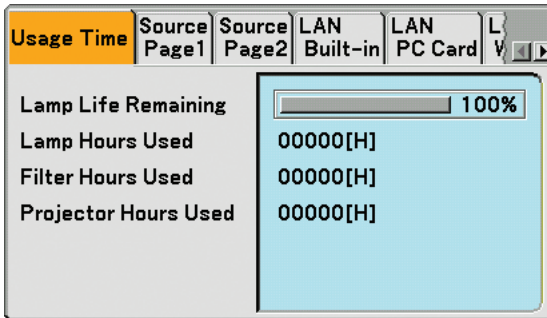

Lamp Life Remaining (%)

Lamp Hours Used (H)

Filter Hours Used (H)

Projector Hours Used (H)

*NOTE: The progress indicator shows the percentage of remaining lamp life. The value informs you of the amount of lamp, filter and projector usage respectively.*

- When the remaining lamp time reaches 0, the Lamp Life Remaining bar indicator changes from 0% to 100 Hours and the count-down starts.  
If lamp life remaining time reaches 0 hours, the projector will not turn on regardless of whether the lamp mode is set to Normal or Eco.
- The message to the effect that the lamp should be replaced will be displayed for one minute when the projector is turned on or off. To dismiss this message, press any button on the projector or the remote control.

**[Source Page1]**

Usage Time	Source Page1	Source Page2	LAN Built-in	LAN PC Card	L V
Input Terminal	Video				
Signal Type	Video				
Video Type	NTSC3.58				
Source Name	NTSC3.58				
Entry No.	3				

Input Terminal  
 Video Type  
 Entry No.

Signal Type  
 Source Name

**[Source Page2]**

Usage Time	Source Page1	Source Page2	LAN Built-in	LAN PC Card	L V
Horizontal Frequency	15.73[kHz]				
Vertical Frequency	59.93[Hz]				
Sync Type	---				
Sync Polarity	---				
Scan Type	Non-Interlace				

Horizontal Frequency  
 Sync Type  
 Scan Type

Vertical Frequency  
 Sync Polarity

**[LAN Built-in]**

Usage Time	Source Page1	Source Page2	LAN Built-in	LAN PC Card	L V
IP Address	192.168. 10. 10				
Subnet Mask	255.255.255. 0				
Gateway	. . .				
MAC Address	00-02-78-E0-8C-B4				

This page shows information on settings for the LAN port (RJ-45)

IP Address ..... Indicates the IP address of the projector when the LAN port (RJ-45) is used.

Subnet Mask ..... Indicates the subnet mask of the projector when the LAN port (RJ-45) is used

Gateway ..... Indicates the gateway of the network connected to the projector when the LAN port (RJ-45) is used.

MAC Address ..... Indicates the MAC address of the LAN port (RJ-45).

**[LAN PC Card]**

Usage Time	Source Page1	Source Page2	LAN Built-in	LAN PC Card	L V
IP Address	192.168. 10. 11				
Subnet Mask	255.255.255. 0				
Gateway	. . .				
MAC Address	00-02-78-E0-8C-B4				

This page shows information on settings for the optional wireless LAN card

IP Address ..... Indicates the IP address of the projector when the optional wireless LAN card is used.

Subnet Mask ..... Indicates the subnet mask of the projector when the optional wireless LAN card is used.

Gateway ..... Indicates the gateway of the network connected to the projector when the optional wireless LAN card is used.

MAC Address ..... Indicates the MAC address of the optional wireless LAN card.

**[LAN Wireless]**

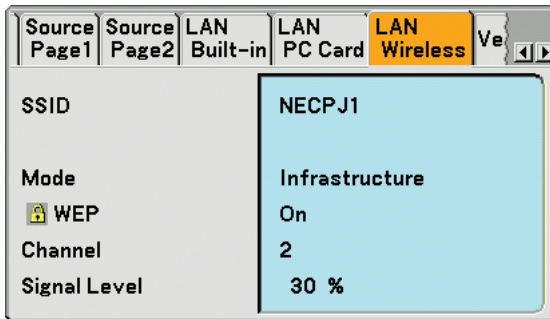

This page shows information on settings for WEP key for encryption.

- SSID ..... Indicates the identifier (SSID) for your wireless LAN.
- Mode ..... Indicates that [Easy Connection], [Infrastructure] or [802.11 Ad Hoc] is selected for your communication method
- WEP ..... Indicates your selected datalength encryption: On or Off
- Channel ..... Indicates the channel you selected in the [Site Survey]. The channel must match for all wireless devices communicating on your wireless LAN.
- Signal Level ..... Indicates receiving condition of radio signal level while you are using a wireless LAN connection (Only when PC Card is used)

**[Version]**

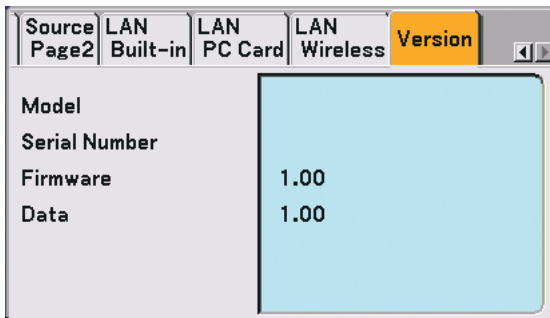

- Model
- Serial Number
- Firmware
- Data



## 8 Menu Descriptions & Functions [Reset]



### Returning to Factory Default

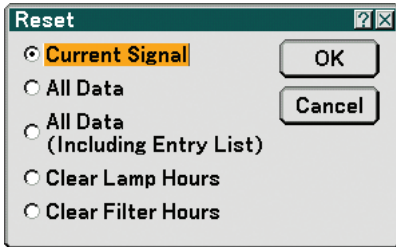

The Reset feature allows you to change adjustments and settings to the factory preset for sources by the following methods:

#### [Current Signal]

Resets the adjustments for the current signal to the factory preset levels.  
All the items in [Adjust] can be reset.

#### [All Data]

Reset all the adjustments and settings for all the signals to the factory preset except [Entry List], [Language], [Background], [Control Panel Lock], [Menu Lock], [Logo Lock], [Security], [PJLink], [LAN Mode], [Projector Name], [Communication Speed], [Date, Time Preset], [Lamp Life Remaining], [Lamp Hours Used], [Filter Hours Used] and [Projector Hours Used].

#### [All Data (Including Entry List)]

Reset all the adjustments and settings for all the signals to the factory preset except [Language], [Background], [Control Panel Lock], [Menu Lock], [Logo Lock], [Security], [PJLink], [LAN Mode], [Projector Name], [Communication Speed], [Date, Time Preset], [Lamp Life Remaining], [Lamp Hours Used], [Filter Hours Used] and [Projector Hours Used].

Also deletes all the signals in the [Entry List] and returns to the factory preset.

---

*NOTE: Locked signals in Entry List cannot be reset.*

---

#### Clearing Lamp Hour Meter [Clear Lamp Hours]

Resets the lamp clock back to zero.

---

*NOTE: Elapsed time of the lamp use will not be affected even when [Reset] is done from the menu.*

---

*NOTE: The projector will turn off and go into standby mode after 2100 hours (up to 3100 hours in Eco mode) of service. In this condition you cannot clear the lamp hour meter on the menu. If this happens, press the HELP button on the remote control for 10 seconds to reset the lamp clock back to zero. Do this only after replacing the lamp.*

---

#### Resetting the Filter Usage Hours [Clear Filter Hours]

Resets the filter usage back to zero.

---

*NOTE: Elapsed time of the filter use will not be affected even when [Reset] is done from the menu.*

---

# 7. Maintenance

---

This section describes the simple maintenance procedures you should follow to clean the filters and replace the lamp.

## ① Cleaning or Replacing the Filter

The air-filter sponge keeps dust and dirt from getting inside the projector and should be cleaned after every 100 hours of operation (more often in dusty conditions). If the filter is dirty or clogged, your projector may overheat.

### CAUTION

- Turn off the projector, turn off the main power switch and unplug the projector before replacing the filter.
- Only clean the outside of the filter cover with a vacuum cleaner.
- Do not attempt to operate the projector without the filter cover.

### To clean the air-filter:

Vacuum the filter-through the filter cover.

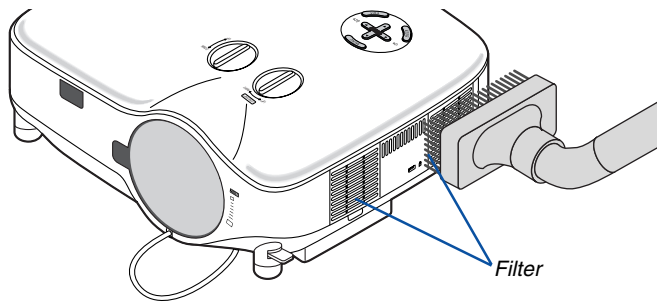

To reset the filter usage time, from the menu, select [Reset] → [Clear Filter Hours].  
(→ page 107 for resetting the filter usage time)

### To replace the filter (sponge):

### CAUTION

- Replace both filters at the same time.
- Before replacing the filters, remove dust and dirt from the projector cabinet.
- The projector contains high-precision parts. Keep out dust and dirt during filter replacement.
- Do not wash the filter with water. Water will damage the filter membrane.
- Reattach the filter cover correctly. Failure to do so may cause projector malfunction.

**Preparation:** Replace the lamp before replacing the filters.

---

*NOTE: When you replace the lamp, it is also wise to replace the filter. The filter comes in the same package with your replacement lamp.*

---

### 1. Pull to remove the filter cover.

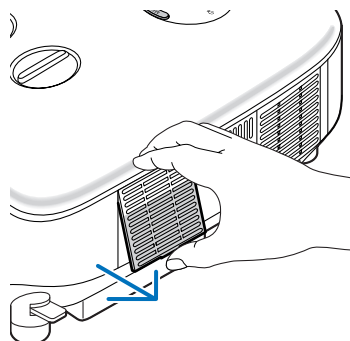

2. Gently peel off the filter (sponge) and replace it with the new one.

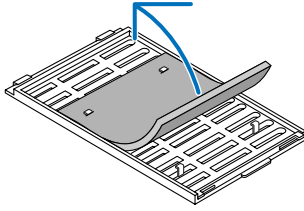

*The filter is attached self-adhesive tape. Peel off a release paper before use.*

3. Reinstall the new filter cover.

- Slip the filter cover back until it snaps into place.

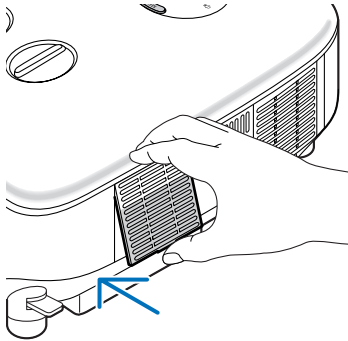

4. Connect the supplied power cable, turn on the Main Power switch and turn on the projector.

5. Finally, select the menu → [Reset] → [Clear Filter Hours] to reset the filter usage hours.

(→ page 107 for resetting the filter usage time)

## ② Cleaning the Cabinet and the Lens

1. Turn off the projector before cleaning.
2. Clean the cabinet periodically with a damp cloth. If heavily soiled, use a mild detergent. Never use strong detergents or solvents such as alcohol or thinner.
3. Use a blower or lens paper to clean the lens, and be careful not to scratch or mar the lens.

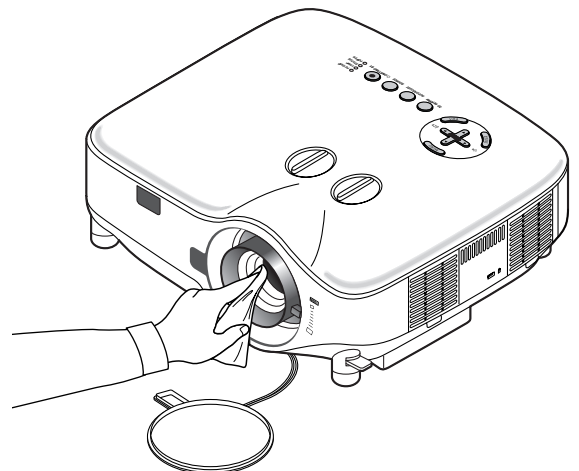
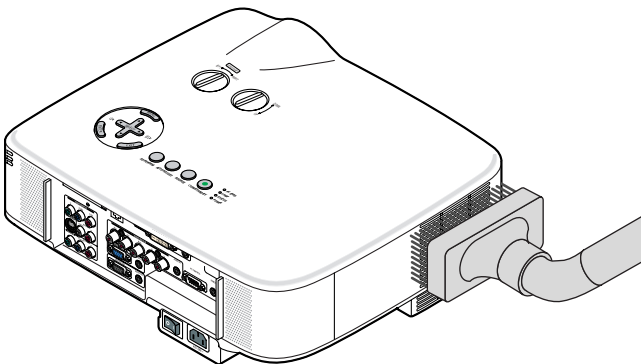

### ③ Replacing the Lamp

After your lamp has been operating for 2000 hours (up to 3000 hours in Eco mode) or longer, the LAMP indicator in the cabinet will blink red. Even though the lamp may still be working, replace it at 2000 (up to 3000 hours in Eco mode) hours to maintain optimal projector performance. After replacing the lamp, be sure to clear the lamp hour meter. (→ page 107)

#### CAUTION

- **DO NOT TOUCH THE LAMP** immediately after it has been used. It will be extremely hot. Turn the projector off, wait 30 seconds, turn off the main power switch and then disconnect the power cable. Allow at least one hour for the lamp to cool before handling.
- **DO NOT REMOVE ANY SCREWS** except two lamp housing screws. You could receive an electric shock.
- Do not break the glass on the lamp housing.  
Keep finger prints off the glass surface on the lamp housing. Leaving finger prints on the glass surface might cause an unwanted shadow and poor picture quality.
- The projector will turn off and go into standby mode after 2100 (up to 3100 hours in Eco mode) hours of service. If this happens, be sure to replace the lamp. If you continue to use the lamp after 2000 hours (up to 3000 hours in Eco mode) of use, the lamp bulb may shatter, and pieces of glass may be scattered in the lamp case. Do not touch them as the pieces of glass may cause injury. If this happens, contact your NEC dealer for lamp replacement.

#### To replace the lamp:

Optional lamp and tools needed for replacement:

- Replacement lamp NP01LP
- Phillips screwdriver or equivalent

#### 1. Use a Phillips screwdriver to push and release the tab.

*Push and pull to remove the lamp cover.*

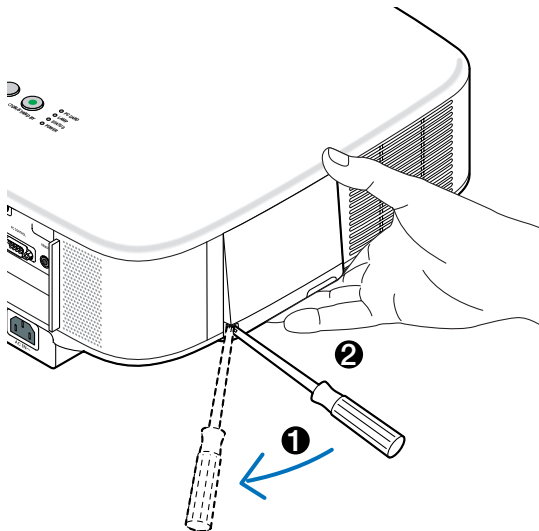

2. Loosen the two screws securing the lamp housing until the phillips screwdriver goes into a freewheeling condition. The two screws are not removable. Remove the lamp housing by holding it.

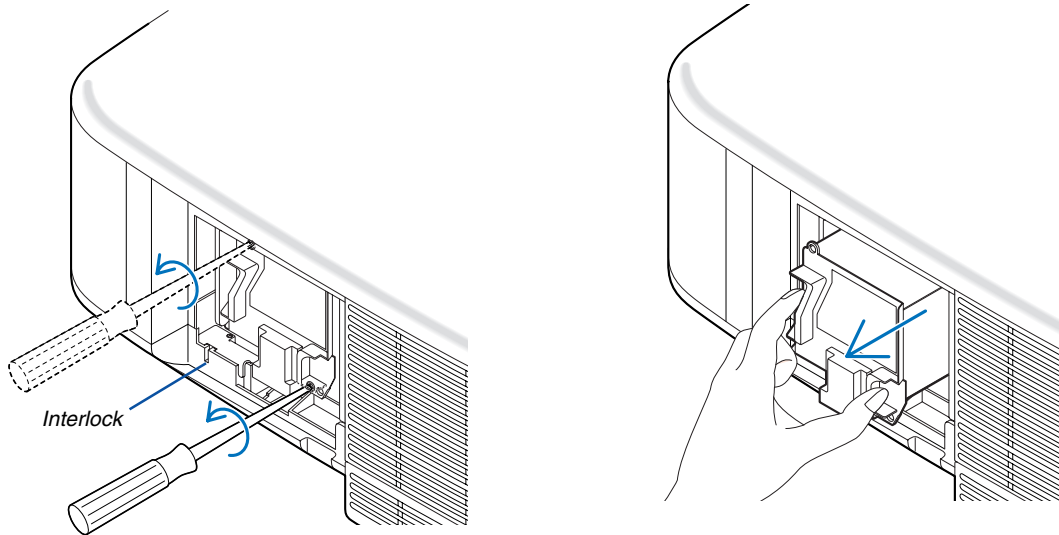

*NOTE: There is an interlock on this case to prevent the risk of electrical shock. Do not attempt to circumvent this interlock.*

3. Insert a new lamp housing until the lamp housing is plugged into the socket.

### CAUTION

Do not use a lamp other than the NEC replacement lamp NP01LP.  
Order this from your NEC dealer.

- Secure it in place with the two screws.  
Be sure to tighten the screws.

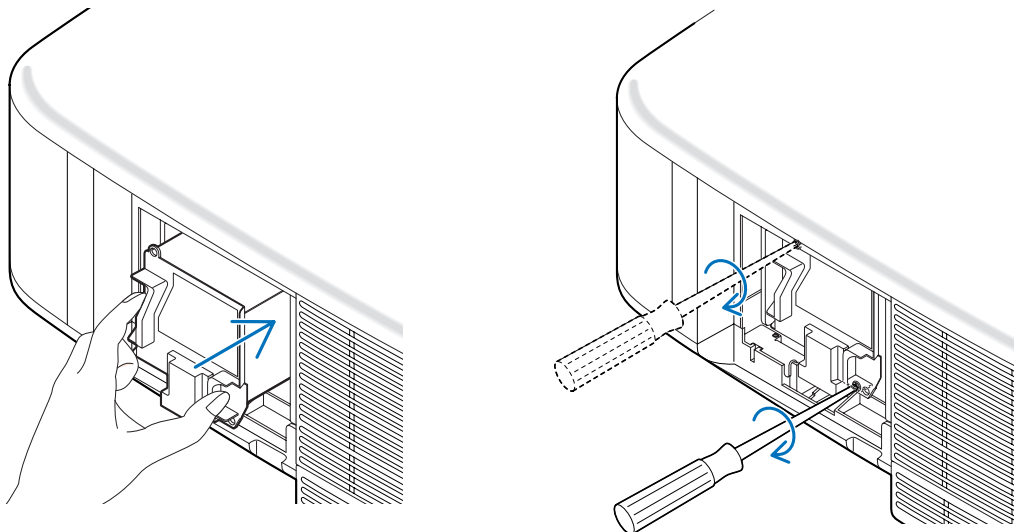

### 4. Reattach the lamp cover.

Slip the lamp cover back until it snaps into place.

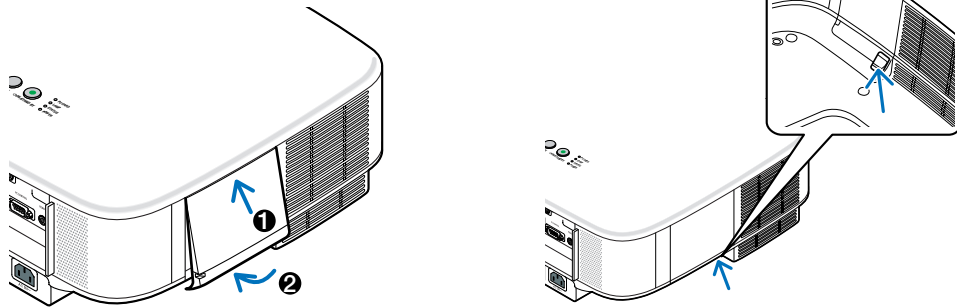

### 5. Connect the supplied power cable, turn on the Main Power switch and turn on the projector.

### 6. Finally, select the menu → [Reset] → [Clear Lamp Hours] to reset the lamp life remaining and lamp usage hours.

---

*NOTE: When the lamp exceeds 2100 hours (up to 3100 hours in Eco mode) of service, the projector cannot turn on and the menu is not displayed.*

*If this happens, press the HELP button on the remote control for 10 seconds to reset the lamp clock back to zero.*

*When the lamp time clock is reset to zero, the LAMP indicator goes out.*

---

# 8. Using Optional Lenses

Five optional lenses are available for the NP2000/NP1000. See the information described on this page to buy the appropriate lens for your screen size and throw distance. See page 115 for installing the lens.

## 1 Table of Throw Distances and Screen Sizes for Optional Lenses

Screen Size	STANDARD		NP01FL		NP02ZL		NP03ZL		NP04ZL		NP05ZL	
	1.5 - 2.0		0.8		1.2 - 1.5		1.9 - 3.1		3.0 - 4.8		4.6 - 7.0	
	(m)	(inches)	(m)	(inches)	(m)	(inches)	(m)	(inches)	(m)	(inches)	(m)	(inches)
30"	0.89 - 1.20	35.1 - 47.3			0.70 - 0.92	27.5 - 36.4						
40"	1.20 - 1.62	47.4 - 63.8	0.64	25.3	0.95 - 1.25	37.3 - 49.1	1.56 - 2.51	61.4 - 98.6				
60"	1.83 - 2.45	72.2 - 96.6	0.98	38.6	1.44 - 1.89	56.9 - 74.5	2.37 - 3.79	93.5 - 149.4	3.60 - 5.83	141.7 - 229.7		
67"	2.05 - 2.75	80.8 - 108.2	1.10	43.3	1.62 - 2.12	63.7 - 83.4	2.66 - 4.25	104.7 - 167.1	4.03 - 6.53	158.8 - 257.0		
72"	2.21 - 2.96	87.0 - 116.4	1.18	46.6	1.74 - 2.28	68.6 - 89.8	2.86 - 4.57	112.8 - 179.8	4.34 - 7.03	171.1 - 276.6		
80"	2.46 - 3.29	96.9 - 129.5	1.32	51.9	1.94 - 2.54	76.4 - 99.9	3.19 - 5.08	125.6 - 200.1	4.84 - 7.82	190.6 - 307.9	7.65 - 11.73	301.3 - 462.0
84"	2.59 - 3.46	101.8 - 136.1	1.39	54.6	2.04 - 2.67	80.3 - 105.0	3.35 - 5.34	132.0 - 210.3	5.09 - 8.22	200.4 - 323.5	8.05 - 12.33	316.8 - 485.5
90"	2.78 - 3.71	109.3 - 146.0	1.49	58.6	2.19 - 2.86	86.2 - 112.6	3.60 - 5.73	141.7 - 225.5	5.46 - 8.81	215.0 - 346.9	8.63 - 13.23	340.0 - 520.7
100"	3.09 - 4.13	121.6 - 162.4	1.66	65.3	2.44 - 3.18	96.0 - 125.4	4.01 - 6.37	157.7 - 250.8	6.08 - 9.81	239.5 - 386.0	9.62 - 14.72	378.6 - 579.4
120"	3.72 - 4.96	146.3 - 195.3	2.00	78.6	2.93 - 3.83	115.5 - 150.8	4.82 - 7.66	189.8 - 301.6	7.32 - 11.79	288.3 - 464.2	11.58 - 17.70	455.8 - 696.8
150"	4.66 - 6.21	183.4 - 244.6	2.50	98.6	3.68 - 4.80	144.9 - 188.9	6.05 - 9.59	238.0 - 377.7	9.18 - 14.77	361.6 - 581.5	14.52 - 22.17	571.7 - 872.9
180"	5.60 - 7.47	220.5 - 294.0			4.42 - 5.77	174.2 - 227.1	7.27 - 11.53	286.2 - 453.8	11.05 - 17.75	434.9 - 698.7	17.46 - 26.65	687.5 - 1049.0
200"	6.23 - 8.30	245.3 - 326.9			4.92 - 6.41	193.8 - 252.5	8.08 - 12.81	318.3 - 504.5	12.29 - 19.73	483.8 - 776.9	19.43 - 29.63	764.8 - 1166.4
210"	6.54 - 8.72	257.6 - 343.3			5.17 - 6.74	203.5 - 265.2	8.49 - 13.46	334.3 - 529.9	12.91 - 20.73	508.2 - 816.0	20.41 - 31.12	803.4 - 1225.1
240"	7.49 - 9.97	294.7 - 392.6			5.91 - 7.71	232.9 - 303.4	9.72 - 15.39	382.5 - 606.0	14.77 - 23.70	581.5 - 933.3	23.35 - 35.59	919.3 - 1401.2
250"	7.80 - 10.39	307.1 - 409.1			6.16 - 8.03	242.7 - 316.1	10.12 - 16.04	398.6 - 631.4	15.39 - 24.70	605.9 - 972.4	24.33 - 37.08	957.9 - 1459.9
270"	8.43 - 11.23	331.8 - 442.0			6.66 - 8.67	262.2 - 341.5	10.94 - 17.33	430.7 - 682.1	16.63 - 26.68	654.8 - 1050.5	26.29 - 40.06	1035.1 - 1577.3
300"	9.37 - 12.48	368.9 - 491.3			7.41 - 9.64	291.5 - 379.7	12.16 - 19.26	478.8 - 758.2	18.49 - 29.66	728.1 - 1167.8	29.23 - 44.54	1151.0 - 1753.5
400"	12.51 - 16.66	492.5 - 655.8			9.89 - 12.87	389.3 - 506.8	16.24 - 25.70	639.4 - 1011.9	24.70 - 39.59	972.4 - 1558.7	39.04 - 59.45	1537.2 - 2340.5
500"	15.65 - 20.83	616.2 - 820.2			12.37 - 16.10	487.1 - 634.0	20.32 - 32.15	799.9 - 1265.6	30.90 - 49.52	1216.7 - 1949.5	48.85 - 74.36	1923.4 - 2927.5

For screen sizes between 30" and 500" not indicated on the above table, use formulas below.

Throw distance for Standard lens (m/inch)=H × 1.5 through H × 2.0 Distance from 0.89m to 20.83m/35.1" to 820.2"

Throw distance for NP01FL(m/inch)=H × 0.8 Distance from 0.64m to 2.5m/25.3" to 98.6"

Throw distance for NP02ZL(m/inch)=H × 1.2 through H × 1.5 Distance from 0.7m to 16.1m/27.5" to 634"

Throw distance for NP03ZL(m/inch)=H × 1.9 through H × 3.1 Distance from 1.56m to 32.15m/61.4" to 1265.6"

Throw distance for NP04ZL(m/inch)=H × 3.0 through H × 4.8 Distance from 3.6m to 49.52m/141.7" to 1949.5"

Throw distance for NP05ZL(m/inch)=H × 4.6 through H × 7.0 Distance from 7.65m to 74.36m/301.3" to 2927.5"

"H" = Screen width

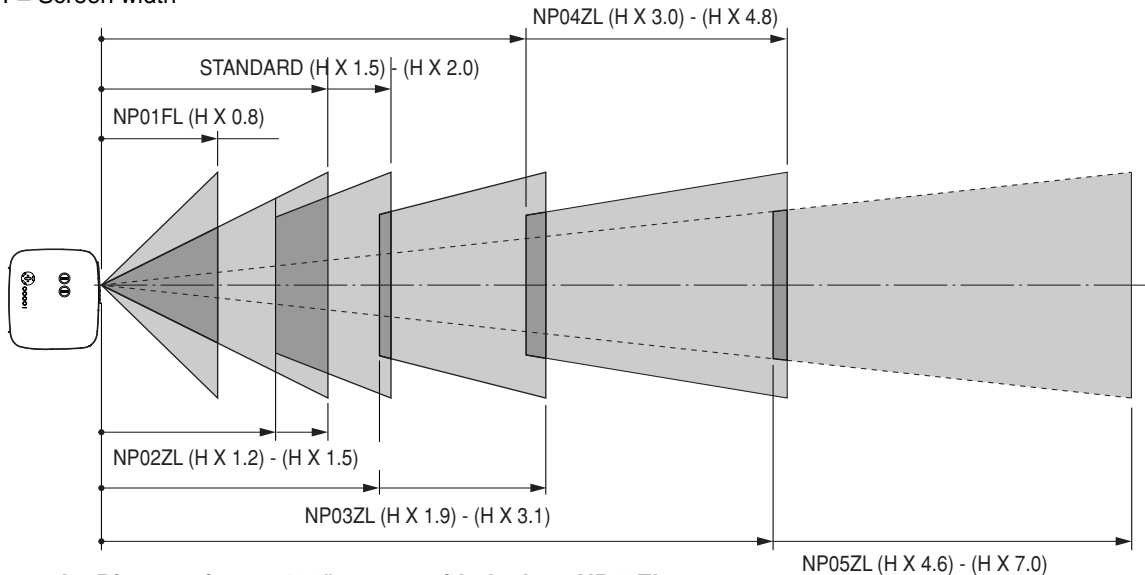

### Example: Distance from a 100" screen with the lens NP03ZL

Referring to the diagram on page 124, "H" is 2.0 m/78.7". Therefore, the projection distances of 100 inches are from 2.0 m/78.7" × 1.9 to 2.0 m/78.7" × 3.1 = from 3.8 m/150" to 6.2 m/244".

NOTE: Distances may vary +/-5%

## ② Lens Shift Adjustable Range

The top right diagram shows the location of the image position in the lens. The lens can be shifted within the shaded area as shown using the normal projection position as a starting point. The projector has a lens shift feature that allows you to move the image vertically or horizontally.

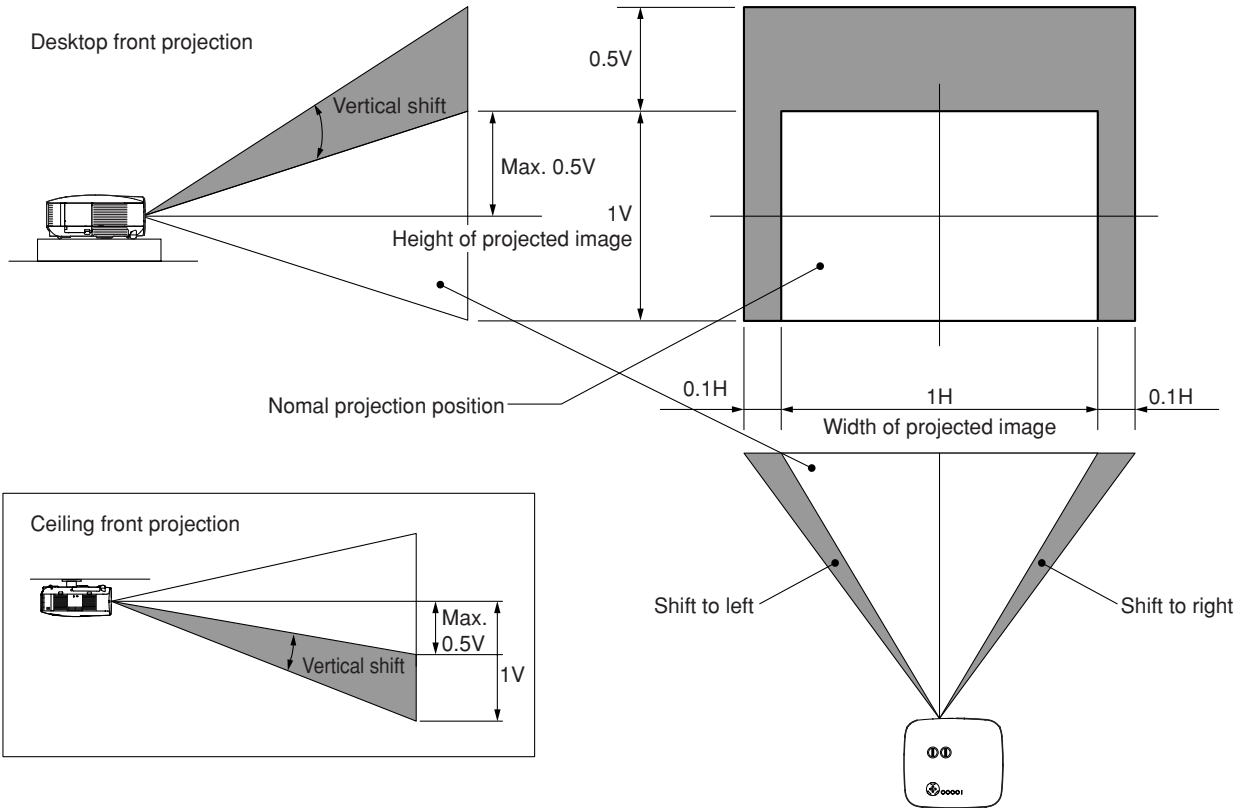



### ③ Replacing with Optional Lens

#### CAUTION

- Do not give a shock or excessive load to the projector or the lens components as the projector and lens components contain precision parts.
- When shipping the projector with the optional lens, remove the optional lens before shipping the projector. The lens and the lens shift mechanism may encounter damage caused by improper handling during transportation.
- Before removing or installing the lens, be sure to turn off the projector, wait until the cooling fans stop, and turn off the main power switch.
- Do not touch the lens surface when removing or installing the lens.
- Keep fingerprints, dust or oil off the lens surface. Do not scratch the lens surface.
- Work on a level surface with a soft cloth under it to avoid scratching.
- If you remove and store the lens, attach the lens cap to the projector to keep off dust and dirt.
- Please heed the following information if you own two or more NP2000/NP1000 projectors and may interchange the standard lenses.

When replacing the standard lens (with an optional lens) and then re-installing the standard lens back into the projector, the standard lens must go back to its original projector from which it was removed.

If you remove the standard lens from one NP2000/NP1000 projector and re-install it into another NP2000/NP1000 projector, performance may be compromised.

Be sure to use the standard lens in combination with its original factory-adjusted projector.

#### Remove the existing lens from the projector.

1. **Rotate the lens counterclockwise while strongly pushing the LENS RELEASE button all the way in.**

The existing lens will be disengaged.

*NOTE: If the lens cannot be removed even by using the LENS RELEASE button, the anti-theft screw for lens may be used to secure the lens. If such is the case, remove the anti-theft screw first. (→ page 116)*

2. **Pull out the existing lens slowly.**

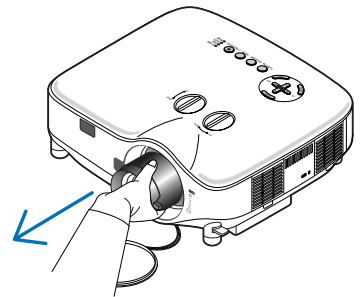
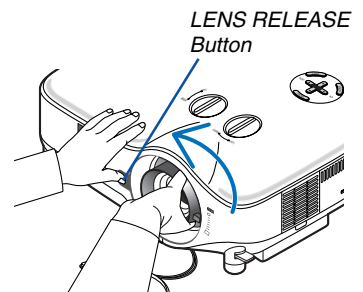

## 8. Using Optional Lenses

### Install the new lens

**1. Insert the lens with the yellow protrusion on top.**

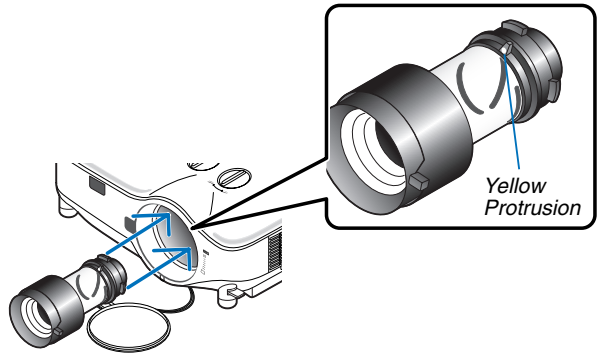

**2. Rotate the lens clockwise.**

Rotate the lens until you feel it click into place.

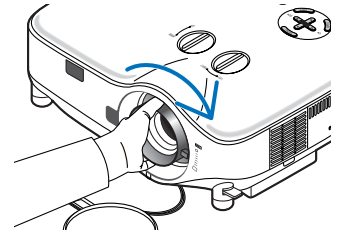

### **Using the anti-theft screw to prevent theft of the lens**

Tighten the supplied anti-theft screw on the front bottom.

Hole of anti-theft screw for lens unit

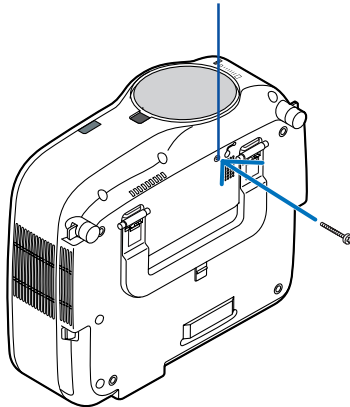

# 9. Appendix

## 1 Troubleshooting

This section helps you resolve problems you may encounter while setting up or using the projector.

### Indicator Messages

#### Power Indicator

Indicator Condition			Projector Condition	Note
Off			The main power is off	–
Blinking light	Green	0.5 sec On, 0.5 sec Off	The projector is getting ready to turn on.	Wait for a moment.
		2.5 sec On, 0.5 sec Off	Off Timer or Program Timer (Off Time) is activated.	–
	Orange	0.5 sec On, 0.5 sec Off	The projector is cooling down.	Wait for a moment.
		2.5 sec On, 0.5 sec Off	Program Timer (On Time) is activated.	–
Steady light	Green		The projector is turned on.	–
	Orange		The projector is in Standby.	–

#### Status Indicator

Indicator Condition			Projector Condition	Note
Off			Normal	–
Blinking light	Red	1 cycle (0.5 sec On, 2.5 sec Off)	Lamp cover error	Reattach the lamp cover correctly. (→ page 112)
		2 cycle (0.5 sec On, 0.5 sec Off)	Temperature error	The projector is overheated. Move the projector to a cooler location.
		3 cycle (0.5 sec On, 0.5 sec Off)	Power error	Power unit will not work correctly.
		4 cycle (0.5 sec On, 0.5 sec Off)	Fan error	Fans will not work correctly.
		6 cycle (0.5 sec On, 0.5 sec Off)	Lamp error	Lamp fails to light. Wait a full minute and then turn on again.
	Green		Re-firing the lamp	The projector is re-firing.
	Orange	1 cycle (0.5 sec On, 2.5 sec Off)	Network conflict	Both the built-in LAN and the wireless LAN cannot be connected to the same network at the same time. To use both built-in LAN and wireless LAN at the same time, connect them to different networks. (→ page 90, 91)
Steady light	Orange		Control Panel Lock is on	You have pressed cabinet button when Control Panel Lock is on. (→ page 82)
	Green		The projector is in Standby.	–

#### Lamp Indicator

Indicator Condition			Projector Condition	Note
Off			Normal	–
Blinking light	Red		Lamp has reached its end of life. Lamp replacement message will be displayed.	Replace the lamp. (→ page 110)
Steady light	Red		Lamp has been used beyond its limit. The projector will not turn on until the lamp is replaced.	Replace the lamp. (→ page 110)
	Green		Lamp is in Eco mode	–

## Common Problems &amp; Solutions (→ "Power/Status/Lamp Indicator" on page 117)

Problem	Check These Items
Does not turn on	<ul style="list-style-type: none"> <li>• Check that the power cable is plugged in and that the power button on the projector cabinet or the remote control is on. (→ page 23, 24)</li> <li>• Ensure that the lamp cover is installed correctly. (→ page 112)</li> <li>• Check to see if the projector has overheated. If there is insufficient ventilation around the projector or if the room where you are presenting is particularly warm, move the projector to a cooler location.</li> <li>• Check to see if the lamp usage exceeds 2100 hours (up to 3100 hours : Eco mode). If so, replace the lamp. After replacing the lamp, reset the lamp hours used. (→ page 107)</li> <li>• The lamp may fail to light. Wait a full minute and then turn on the power again.</li> </ul>
Will turn off	<ul style="list-style-type: none"> <li>• Ensure that the Power Management, Off Timer or Program Timer is off. (→ page 97, 99)</li> <li>• Check to see if the lamp usage exceeds 2100 hours (up to 3100 hours : Eco mode). If so, replace the lamp. After replacing the lamp, reset the lamp hours used. (→ page 107)</li> </ul>
No picture	<ul style="list-style-type: none"> <li>• Use the SOURCE button on the projector cabinet or the VIDEO, the S-VIDEO, the COMPUTER 1, the COMPUTER 2, the COMPUTER 3, the COMPONENT, the VIEWER or the LAN button on the remote control to select your source. (→ page 26)</li> <li>• Ensure your cables are connected properly.</li> <li>• Use menus to adjust the brightness and contrast. (→ page 74)</li> <li>• Check to see if the image is muted. (→ page 36)</li> <li>• Remove the lens cap.</li> <li>• Reset the settings or adjustments to factory preset levels using the Reset in the Menu. (→ page 107)</li> <li>• Enter your registered keyword if the Security function is enabled. (→ page 45)</li> <li>• Be sure to connect the projector and notebook PC while the projector is in standby mode and before turning on the power to the notebook PC. In most cases the output signal from the notebook PC is not turned on unless connected to the projector before being powered up. * If the screen goes blank while using your remote control, it may be the result of the computer's screen-saver or power management software.</li> <li>• See also the next page.</li> </ul>
Color tone or hue is unusual	<ul style="list-style-type: none"> <li>• Check if an appropriate color is selected in [Wall Color]. If not, select an appropriate option. (→ page 81)</li> <li>• Adjust [Hue] in [Adjust]. (→ page 74)</li> </ul>
Image isn't square to the screen	<ul style="list-style-type: none"> <li>• Reposition the projector to improve its angle to the screen. (→ page 27)</li> <li>• Use the 3DReform function to correct the trapezoid distortion. (→ page 31)</li> </ul>
Picture is blurred	<ul style="list-style-type: none"> <li>• Adjust the focus. (→ page 29)</li> <li>• Reposition the projector to improve its angle to the screen. (→ page 27)</li> <li>• Ensure that the distance between the projector and screen is within the adjustment range of the lens. (→ page 123, 124)</li> <li>• Condensation may form on the lens if the projector is cold, brought into a warm place and is then turned on. Should this happen, let the projector stand until there is no condensation on the lens.</li> </ul>
Image is scrolling vertically, horizontally or both	<ul style="list-style-type: none"> <li>• Use the SOURCE button on the projector cabinet or the VIDEO, the S-VIDEO, the COMPUTER 1, the COMPUTER 2, the COMPUTER 3, the COMPONENT, the VIEWER or the LAN button on the remote control to select your source (Video, S-Video, Computer, Component, Viewer or LAN). (→ page 26)</li> <li>• Adjust the computer image manually with the [Clock]/[Phase] in [Adjust] → [Image Options]. (→ page 75)</li> </ul>
Remote control does not work	<ul style="list-style-type: none"> <li>• Install new batteries. (→ page 10)</li> <li>• Make sure there are no obstacles between you and the projector.</li> <li>• Stand within 22 feet (7 m) of the projector. (→ page 10)</li> <li>• Check if one or more remote sensors are enabled. Select [Setup] → [Installation] → [Remote Sensor] from the menu. See page 96.</li> <li>• If the remote control cable plug is inserted into the REMOTE mini jack, the remote control does not function wirelessly. See page 11.</li> </ul>
Indicator is lit or blinking	<ul style="list-style-type: none"> <li>• See the POWER/STATUS/LAMP Indicator. (→ page 117)</li> </ul>
Vertical stripes in RGB mode	<ul style="list-style-type: none"> <li>• Press the AUTO ADJUST button on the projector cabinet or the AUTO ADJ. button on the remote control. (→ page 33)</li> <li>• Adjust the computer image manually with the [Clock]/[Phase] in [Adjust] → [Image Options]. (→ page 75)</li> </ul>
USB mouse does not work	<ul style="list-style-type: none"> <li>• Make sure that your USB mouse is properly connected to the projector. (→ page 38) The projector may not support some brands of a USB mouse.</li> </ul>

For more information contact your dealer.

**If there is no picture, or the picture is not displayed correctly.**

- Power on process for the projector and the PC.

Be sure to connect the projector and notebook PC while the projector is in standby mode and before turning on the power to the notebook PC.

In most cases the output signal from the notebook PC is not turned on unless connected to the projector before being powered up.

---

*NOTE: You can check the horizontal frequency of the current signal in the projector's menu under Information. If it reads "0kHz", this means there is no signal being output from the computer. See page 104 or go to next step.*

---

- Enabling the computer's external display.

Displaying an image on the notebook PC's screen does not necessarily mean it outputs a signal to the projector. When using a PC compatible laptop, a combination of function keys will enable/disable the external display. Usually, the combination of the 'Fn' key along with one of the 12 function keys gets the external display to come on or off. For example, NEC laptops use Fn + F3, while Dell laptops use Fn + F8 key combinations to toggle through external display selections.

- Non-standard signal output from the computer

If the output signal from a notebook PC is not an industry standard, the projected image may not be displayed correctly. Should this happen, deactivate the notebook PC's LCD screen when the projector display is in use. Each notebook PC has a different way of deactivate/reactivate the local LCD screens as described in the previous step. Refer to your computer's documentation for detailed information.

- Image displayed is incorrect when using a Macintosh

When using a Macintosh with the projector, set the DIPswitch of the Mac adapter (not supplied with the projector) according to your resolution. After setting, restart your Macintosh for the changes to take affect.

For setting display modes other than those supported by your Macintosh and the projector, changing the DIP switch on a Mac adapter may bounce an image slightly or may display nothing. Should this happen, set the DIP switch to the 13" fixed mode and then restart your Macintosh. After that, restore the DIP switches to a displayable mode and then restart the Macintosh again.

---

*NOTE: A Video Adapter cable manufactured by Apple Computer is needed for a PowerBook which does not have a mini D-Sub 15-pin connector.*

---

- Mirroring on a PowerBook

\* When using the projector with a Macintosh PowerBook, output may not be set to 1024 x 768 unless "mirroring" is off on your PowerBook. Refer to owner's manual supplied with your Macintosh computer for mirroring.

- Folders or icons are hidden on the Macintosh screen

Folders or icons may not be seen on the screen. Should this happen, select [View] → [Arrange] from the Apple menu and arrange icons.

## ② Specifications

This section provides technical information about the projector's performance.

Model Number NP2000/NP1000

### Optical

LCD Panel 0.8" p-Si TFT active-matrix with Micro Lens Array (Aspect ratio 4:3)  
 Resolution 1024 × 768 pixels\* up to UXGA with Advanced AccuBlend (up to 1400 × 1050 @ 60 Hz on DVI-D)  
 Standard Lens Manual zoom and focus:  
 F1.7 - 2.2 f=24.4 - 32.6 mm  
 Lamp NP2000 : 300 W AC (252 W in Eco mode)  
 NP1000 : 280 W AC (252 W in Eco mode)  
 Light Output NP2000 : 4000 lumens (approx.80% in Eco)  
 NP1000 : 3500 lumens (approx.85% in Eco)  
 Contrast Ratio(full white: full black) 800:1  
 Image Size (Standard lens) 30" - 500" (0.76 m - 12.7 m) diagonal  
 Lens Options Fixed lens : NP01FL (throw ratio 0.8:1)  
 Zoom lens : NP02ZL (throw ratio 1.2-1.5:1)  
 NP03ZL (throw ratio 1.9-3.1:1)  
 NP04ZL (throw ratio 3.0-4.8:1)  
 NP05ZL (throw ratio 4.6-7.0:1)  
 Lens Shift : Vertical +/- 0.5V, Horizontal +/- 0.1H

### Electrical

Inputs 1 Analog RGB (Mini D-Sub 15 P), 1 Analog RGB R/cr, G/Y, B/cb, H, V (BNC × 5), 1 Digital RGB (DVI-D 24 P), 1 Component Y, Cb/Pb, Cr/Pr (RCA × 3), 1 Component (Mini D-Sub 15 P) shared with COMPUTER 1 IN, 1 S-Video (Mini DIN 4P), 1 Video, 1 PC Card, 3 Stereo Mini Audio, 2 (L/R) RCA Audio, 1 Remote Control (Stereo Mini)  
 Outputs 1 RGB (Mini D-Sub 15P), 1 Stereo Mini Audio  
 Slot 1 PC Card slot (PCMCIA Type II)  
 PC Control 1 PC Control Port (D-Sub 9P)  
 USB Port 1 A Type  
 LAN Port RJ-45  
 Video Compatibility NTSC, NTSC4.43, PAL, PAL-60, PAL-N, PAL-M, SECAM, HDTV: 1080i, 1080i/50Hz, 720p, 576p, 576i, 480p, 480i/60Hz  
 Scan Rate Horizontal: 15 kHz to 108 kHz (RGB: 24 kHz or over)  
 Vertical: 48 Hz to 120 Hz  
 Video Bandwidth RGB: 100 MHz (-3dB)  
 Color Reproduction 16.7 million colors simultaneously, Full color  
 Horizontal Resolution NTSC / NTSC4.43 / PAL / PAL-M / PAL-N / PAL60: 540 TV lines  
 SECAM: 300 TV lines  
 RGB: 1024 dots (H) × 768 dots (V)  
 External Control RS232, IR, LAN, USB  
 Sync Compatibility Separate Sync / Composite Sync / Sync on G  
 Built-in Speakers 5W × 2  
 Power Requirement 100 - 240V AC, 50/60Hz  
 Input Current 4.6A  
 Power Consumption 435W in Lamp Normal mode  
 365W in Lamp Eco mode  
 16W in Standby

\* Effective pixels are more than 99.99%.

**Mechanical**

Installation	Orientation: Desktop/Front, Desktop/Rear, Ceiling/Front, Ceiling/Rear
Dimensions	15.7" (W) × 5.9" (H) × 14.1" (D) 399 mm (W) × 150.5 mm (H) × 358 mm (D) (not including protrusions)
Weight	16.1 lbs/7.3 kg
Environmental Considerations	
Operational Temperatures :	41° to 104°F / 5° to 40°C, (Eco mode selected automatically at 95° to 104°F/35° to 40°C), 20% to 80% humidity (non-condensing)
Storage Temperatures :	14° to 122°F (-10° to 50°C), 20% to 80% humidity (non-condensing)
Regulations	UL/C-UL Approved (UL 60950-1, CSA 60950-1) Meets DOC Canada Class B requirements Meets FCC Class B requirements Meets AS/NZS CISPR.22 Class B Meets EMC Directive (EN55022, EN55024, EN61000-3-2, EN61000-3-3) Meets Low Voltage Directive (EN60950-1, TÜV GS Approved)



For additional information visit:

US : <http://www.necdisplay.com/>

Europe : <http://www.nec-display-solutions.com/>

Global : <http://www.nec-pj.com/>

For information on our optional accessories, visit our website or see our brochure.

The specifications are subject to change without notice.

### 3 Cabinet Dimensions

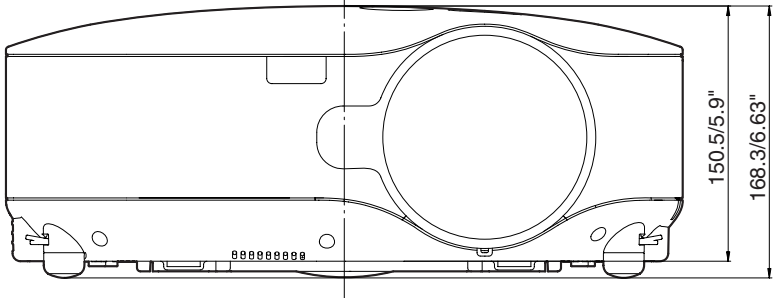
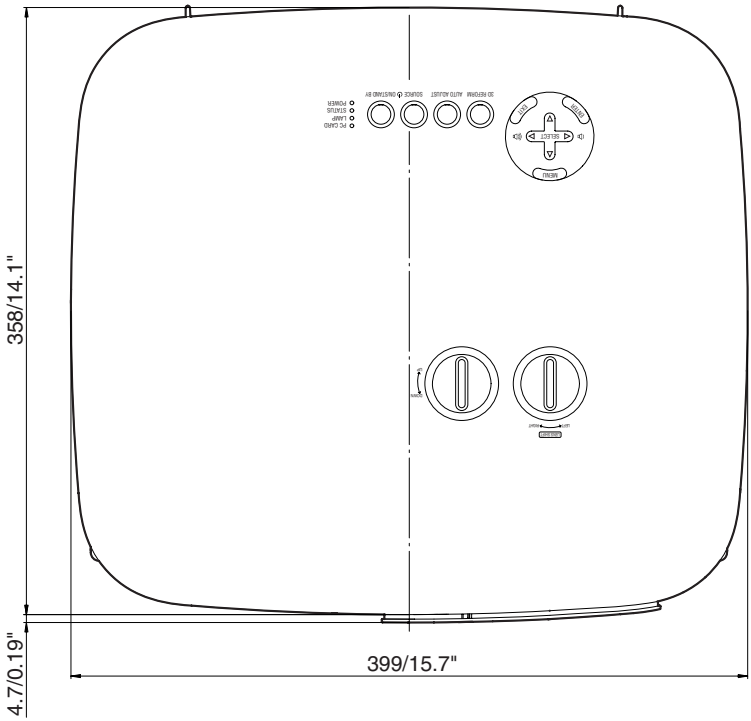
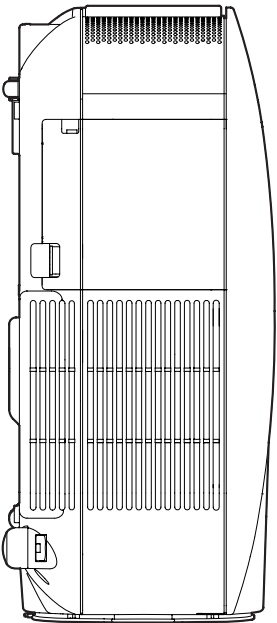
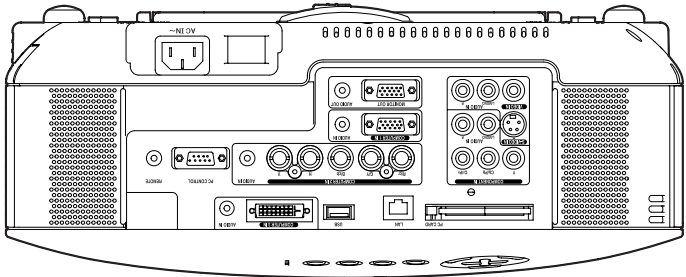

Unit: mm/inch



### 4 Screen Size and Projection Distance

This section should be used when considering the distance to the screen and the screen size.

Available projection distances are 1.0 m/41.2 inches for 30" screen to 18 m/718 inches for 500" screen, according to the chart.

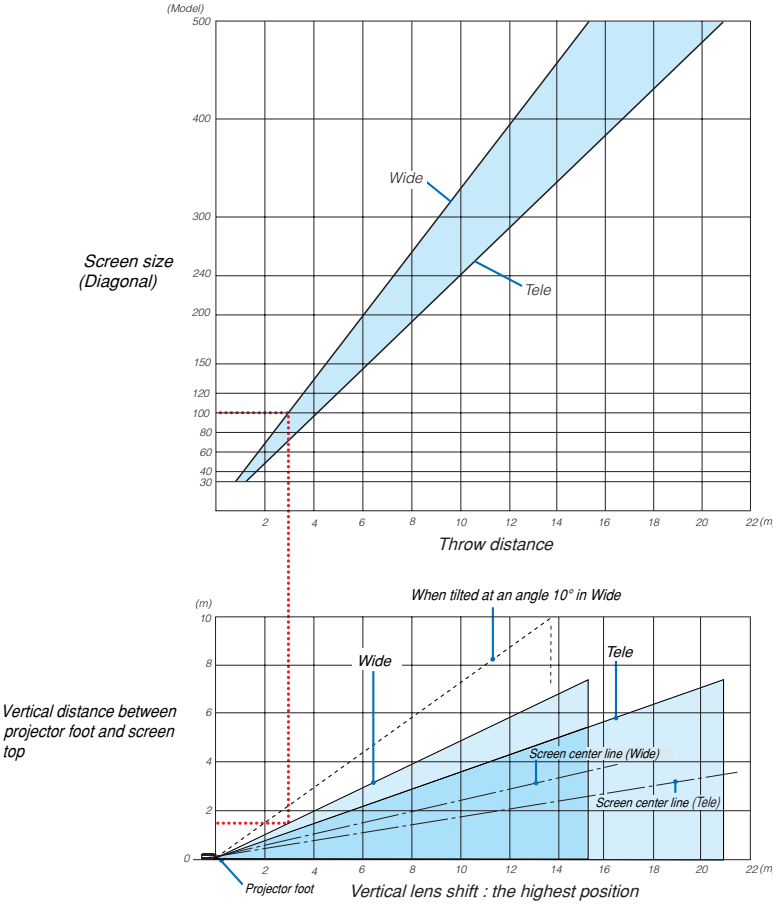

#### Using the Chart

Example for 100" screen:

The projection distance is approximately 3.1 m (122") according to the upper chart. The lower chart shows that the vertical distance between the projector foot and the screen top is approximately 1.5 m (59"). The projection angle can be adjusted up to 10°. (The lower chart shows that the projector is placed in a horizontal position)

List of Screen Sizes

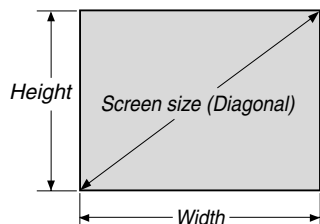

List of Screen Sizes

Screen size	Width (H)		Height (V)	
	m	inch	m	inch
30"	0.6	24.0	0.46	18.0
40"	0.8	31.5	0.6	23.6
60"	1.2	47.2	0.9	35.4
80"	1.6	63.0	1.2	47.2
100"	2.0	78.7	1.5	59.1
120"	2.4	94.5	1.8	70.9
150"	3.0	118.1	2.3	90.6
200"	4.1	161.4	3.0	118.1
250"	5.1	200.8	3.8	149.6
300"	6.1	240.2	4.6	181.1
400"	8.1	318.9	6.1	240.2
500"	10.2	401.6	7.6	299.2

Formulas: Screen width H (m)=Screen size x 4/5 x 0.0254  
 Screen height V (m)=Screen size x 3/5 x 0.0254  
 Screen width H (inch)=Screen size x 4/5  
 Screen height V (inch)=Screen size x 3/5

Screen Size and Projection Distance for Desktop when the standard lens is used

The following drawing shows an example for use of Desktop.

Horizontal projection position: Lens centered left to right

Vertical projection position: See the table below.

Screen size (diagonal)	STANDARD			
	Projection Distance (L)		(H1)	
	(m)	(inches)	(cm)	(inches)
30"	0.89 - 1.20	35.1 - 47.3	0-23	0-9.0
40"	1.20 - 1.62	47.4 - 63.8	0-30	0-12.0
60"	1.83 - 2.45	72.2 - 96.6	0-46	0-18.0
67"	2.05 - 2.75	80.8 - 108.2	0-51	0-20.1
72"	2.21 - 2.96	87.0 - 116.4	0-55	0-21.6
80"	2.46 - 3.29	96.9 - 129.5	0-61	0-24.0
84"	2.59 - 3.46	101.8 - 136.1	0-64	0-25.2
90"	2.78 - 3.71	109.3 - 146.0	0-69	0-27.0
100"	3.09 - 4.13	121.6 - 162.4	0-76	0-30.0
120"	3.72 - 4.96	146.3 - 195.3	0-91	0-36.0
150"	4.66 - 6.21	183.4 - 244.6	0-114	0-45.0
180"	5.60 - 7.47	220.5 - 294.0	0-137	0-54.0
200"	6.23 - 8.30	245.3 - 326.9	0-152	0-60.0
210"	6.54 - 8.72	257.6 - 343.3	0-160	0-63.0
240"	7.49 - 9.97	294.7 - 392.6	0-183	0-72.0
250"	7.80 - 10.39	307.1 - 409.1	0-191	0-75.0
270"	8.43 - 11.23	331.8 - 442.0	0-206	0-81.0
300"	9.37 - 12.48	368.9 - 491.3	0-229	0-90.0
400"	12.51 - 16.66	492.5 - 655.8	0-305	0-120.0
500"	15.65 - 20.83	616.2 - 820.2	0-381	0-150.0

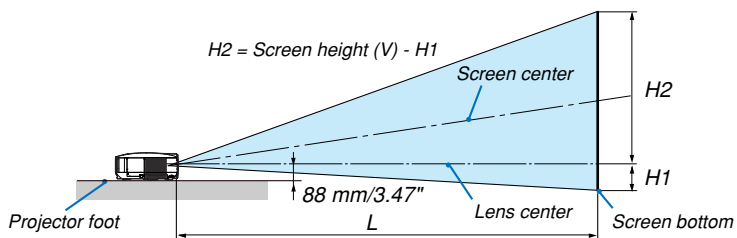

NOTE: Distances may vary +/-5%.

## 5 Pin Assignments of D-Sub COMPUTER 1 Input Connector

### Mini D-Sub 15 Pin Connector

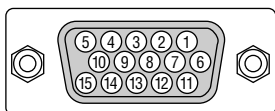

Signal Level  
 Video signal : 0.7Vp-p (Analog)  
 Sync signal : TTL level

Pin No.	RGB Signal (Analog)	YCbCr Signal
1	Red	Cr
2	Green or Sync on Green	Y
3	Blue	Cb
4	Ground	
5	Ground	
6	Red Ground	Cr Ground
7	Green Ground	Y Ground
8	Blue Ground	Cb Ground
9	No Connection	
10	Sync Signal Ground	
11	SCART Sync	
12	Bi-directional DATA (SDA)	
13	Horizontal Sync or Composite Sync	
14	Vertical Sync	
15	Data Clock	

## 6 Compatible Input Signal List

Signal	Resolution ( Dots )	Frequency H. ( kHz )	Refresh Rate ( Hz )
NTSC	–	15.73	60.00
PAL	–	15.63	50.00
PAL60	–	15.73	60.00
SECAM	–	15.63	50.00
D VESA	640 × 480	31.47	59.94
D IBM	640 × 480	31.48	59.95
D MAC	640 × 480	35.00	66.67
D VESA	640 × 480	37.86	72.81
D VESA	640 × 480	37.50	75.00
D IBM	640 × 480	39.38	75.00
D VESA	640 × 480	43.27	85.01
D VESA	800 × 600	35.16	56.25
D VESA	800 × 600	37.88	60.32
D VESA	800 × 600	48.08	72.19
D VESA	800 × 600	46.88	75.00
D VESA	800 × 600	53.67	85.06
D MAC	832 × 624	49.72	74.55
D VESA	1024 × 768	48.36	60.00
D VESA	1024 × 768	56.48	70.07
D MAC	1024 × 768	60.24	74.93
D VESA	1024 × 768	60.02	75.03
D VESA	1024 × 768	68.68	85.00
D VESA	1152 × 864	67.50	75.00
D SUN	1152 × 900	61.80	65.95
D VESA	1280 × 960	60.00	60.00
D VESA	1280 × 1024	63.98	60.02
MAC	1280 × 1024	69.87	65.18
D SXGA+	1400 × 1050	–	60.00
VESA	1600 × 1200	75.00	60.00
VESA	1600 × 1200	81.25	65.00
VESA	1600 × 1200	87.50	70.00
VESA	1600 × 1200	93.75	75.00
D HDTV (1080i)(1125i)	1920 × 1080	33.75	60.00 Interlace
D HDTV (1080i)(1125i)	1920 × 1080	28.13	50.00 Interlace
D HDTV (720p)(750p)	1280 × 720	45.00	60.00 Progressive
D HDTV (720p)	1280 × 720	37.50	50.00 Progressive
D SDTV(576p)(625p)	–	31.25	50.00 Progressive
D SDTV (480p)(525p)	–	31.47	59.94 Progressive
DVD YCbCr	–	15.73	59.94 Interlaced
DVD YCbCr	–	15.63	50.00 Interlaced

D: Images above flagged with "D" are supported by digital signal.

### NOTE:

- Advanced AccuBlend technology is an intelligent pixel blending technology that displays scaled high and low resolution images with true resolution.  
An image with higher or lower resolution than the projector's native resolution (1024 x 768) will be displayed with the Advanced AccuBlend.
- Some composite sync signals may not be displayed correctly.  
Signals other than those specified in the table above may not be displayed correctly. If this should happen, change the refresh rate or resolution on your PC. Refer to Display Properties help section of your PC for procedures.

## 7 PC Control Codes and Cable Connection

### PC Control Codes

Function	Code Data											
POWER ON	02H	00H	00H	00H	00H	02H						
POWER OFF	02H	01H	00H	00H	00H	03H						
INPUT SELECT COMPUTER 1	02H	03H	00H	00H	02H	01H	01H	09H				
INPUT SELECT COMPUTER 2	02H	03H	00H	00H	02H	01H	02H	0AH				
INPUT SELECT COMPUTER 3	02H	03H	00H	00H	02H	01H	1AH	22H				
INPUT SELECT COMPONENT	02H	03H	00H	00H	02H	01H	10H	18H				
INPUT SELECT VIDEO	02H	03H	00H	00H	02H	01H	06H	0EH				
INPUT SELECT S-VIDEO	02H	03H	00H	00H	02H	01H	0BH	13H				
INPUT SELECT VIEWER	02H	03H	00H	00H	02H	01H	1FH	27H				
PICTURE MUTE ON	02H	10H	00H	00H	00H	12H						
PICTURE MUTE OFF	02H	11H	00H	00H	00H	13H						
SOUND MUTE ON	02H	12H	00H	00H	00H	14H						
SOUND MUTE OFF	02H	13H	00H	00H	00H	15H						
ON SCREEN MUTE ON	02H	14H	00H	00H	00H	16H						
ON SCREEN MUTE OFF	02H	15H	00H	00H	00H	17H						
ASPECT RATIO (4:3 Screen)												
4:3	03H	10H	00H	00H	05H	18H	00H	00H	00H	00H	00H	30H
Letterbox	03H	10H	00H	00H	05H	18H	00H	00H	01H	00H	00H	31H
Widescreen	03H	10H	00H	00H	05H	18H	00H	00H	02H	00H	00H	32H
Crop	03H	10H	00H	00H	05H	18H	00H	00H	03H	00H	00H	33H
ASPECT RATIO (16:9 Screen)												
4:3 Window	03H	10H	00H	00H	05H	18H	00H	00H	00H	00H	00H	30H
Letterbox	03H	10H	00H	00H	05H	18H	00H	00H	01H	00H	00H	31H
Widescreen	03H	10H	00H	00H	05H	18H	00H	00H	02H	00H	00H	32H
4:3 Fill	03H	10H	00H	00H	05H	18H	00H	00H	04H	00H	00H	34H
AUTO ADJUST	02H	0FH	00H	00H	02H	05H	00H	18H				

*NOTE: Contact your local dealer for a full list of PC Control Codes if needed.*

### Cable Connection

#### Communication Protocol

Baud rate ..... 38400 bps  
 Data length ..... 8 bits  
 Parity ..... No parity  
 Stop bit ..... One bit  
 X on/off ..... None  
 Communications procedure ..... Full duplex

*NOTE: Depending on the equipment, a lower baud rate may be recommended for long cable runs.*

**PC Control Connector (D-SUB 9P)**

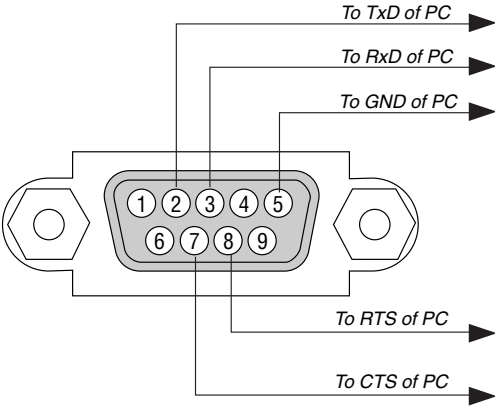

NOTE 1: Pins 1, 4, 6 and 9 are no used.

NOTE 2: Jumper "Request to Send" and "Clear to Send" together on both ends of the cable to simplify cable connection.

NOTE 3: For long cable runs it is recommended to set communication speed within projector menus to 9600 bps.

**8 Using Software Keyboard**

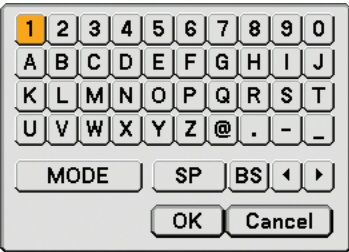

- 1 to 0 and Characters ..... Use to type in password or keyword.
- MODE ..... Selects one of three modes for alphabet and special characters.
- SP ..... Inserts a space
- BS ..... Deletes one character backward
- ◀ ..... Returns to the previous
- ▶ ..... Advances to the next
- OK ..... Executes the selection
- Cancel ..... Cancels the selection

NOTE: You can drag the Software keyboard on the screen by clicking and holding any part on the keyboard except buttons.

## 9 Troubleshooting Check List

Before contacting your dealer or service personnel, check the following list to be sure repairs are needed also by referring to the "Troubleshooting" section in your user's manual. This checklist below will help us solve your problem more efficiently.

\* Print the following pages.

**Frequency of occurrence**  always  sometimes (How often? \_\_\_\_\_)  other (\_\_\_\_\_)

### Power

- No power (POWER indicator does not light green) See also "Status Indicator (STATUS)".
  - Power cable's plug is fully inserted into the wall outlet.
  - Main power switch is pressed to the ON position.
  - Lamp cover is installed correctly .
  - Lamp Hours Used (lamp operation hours) was cleared after lamp replacement.
  - No power even though you press and hold the POWER button for a minimum of 2 seconds.
- Shut down during operation.
  - Power cable's plug is fully inserted into the wall outlet.
  - Lamp cover is installed correctly .
  - Power Management is turned off (only models with the Power Management function).
  - Off Timer is turned off (only models with the Off Timer function ).

### Video and Audio

- No image is displayed from your PC or video equipment to the projector.
  - Still no image even though you connect the projector to the PC first, then start the PC.
  - Enabling your notebook PC's signal output to the projector.
    - *A combination of function keys will enable/disable the external display. Usually, the combination of the "Fn" key along with one of the 12 function keys turns the external display on or off.*
  - No image (blue background, logo, no display).
  - Still no image even though you press the AUTO ADJUST button.
  - Still no image even though you carry out [Reset] in the projector's menu.
  - Signal cable's plug is fully inserted into the input connector
  - A message appears on the screen. ( \_\_\_\_\_ )
  - The source connected to the projector is active and available.
  - Still no image even though you adjust the brightness and/or the contrast.
  - Input source's resolution and frequency are supported by the projector.
- Image is too dark.
  - Remains unchanged even though you adjust the brightness and/or the contrast.
- Image is distorted.
  - Image appears to be trapezoidal (unchanged even though you carry out the [Keystone] or [3D Reform] adjustment).
- Parts of the image are lost.
  - Still unchanged even though you press the AUTO ADJUST button.
  - Still unchanged even though you carry out [Reset] in the projector's menu.
- Image is shifted in the vertical or horizontal direction.
  - Horizontal and vertical positions are correctly adjusted on a computer signal.
  - Input source's resolution and frequency are supported by the projector.
  - Some pixels are lost.
- Image is flickering.
  - Still unchanged even though you press the AUTO ADJUST button.
  - Still unchanged even though you carry out [Reset] in the projector's menu.
  - Image shows flickering or color drift on a computer signal.
- Image appears blurry or out of focus.
  - Still unchanged even though you checked the signal's resolution on PC and changed it to projector's native resolution.
  - Still unchanged even though you adjusted the focus.
- No sound.
  - Audio cable is correctly connected to the audio input of the projector.
  - Still unchanged even though you adjusted the volume level.
  - AUDIO OUT is connected to your audio equipment (only models with the AUDIO OUT connector).

### Other

- Remote control does not work.
  - No obstacles between the sensor of the projector and the remote control.
  - Projector is placed near a fluorescent light that can disturb the infrared remote controls.
  - Batteries are new and are not reversed in installation.
  - If present on the remote control, projector selector switch is not used.
- Buttons on the projector cabinet do not work ( only models with the Control Panel Lock function).
  - Control Panel Lock is not turned on or is disabled in the menu.
  - Still unchanged even though you press and hold the EXIT button for a minimum of 10 seconds.

In the space below please describe your problem in detail.

**Information on application and environment where your projector is used**

**Projector**  
 Model number:  
 Serial No.:  
 Date of purchase:  
 Lamp operating time (hours):  
 Lamp Mode:  Normal  Eco  
 Information on input signal:  
 Horizontal synch frequency [     ] kHz  
 Vertical synch frequency [     ] Hz  
 Synch polarity            H  (+)  (-)  
                                   V  (+)  (-)  
 Synch type                 Separate  Composite  
                                    Sync on Green  
 STATUS Indicator:  
 Steady light                 Orange  Green  
 Flashing light              [     ] cycles  
 Remote control model number:

**Installation environment**  
 Screen size:                      inch  
 Screen type:  White matte  Beads  Polarization  
                                    Wide angle  High contrast  
 Throw distance:                feet/inch/m  
 Orientation:  Ceiling mount  Desktop  
 Power outlet connection:  
 Connected directly to wall outlet  
 Connected to power cord extender or other (the number of connected equipment \_\_\_\_\_)  
 Connected to a power cord reel or other (the number of connected equipment \_\_\_\_\_)

**Computer**  
 Manufacturer:  
 Model number:  
 Notebook PC  / Desktop   
 Native resolution:  
 Refresh rate:  
 Video adapter:  
 Other:

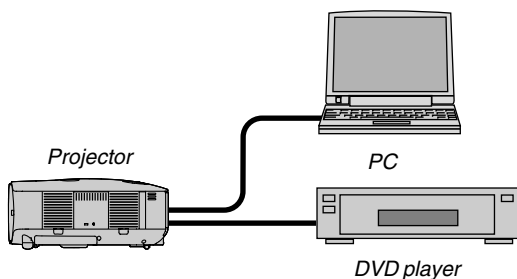

**Signal cable**  
 NEC standard or other manufacturer's cable?  
 Model number:                      Length:                      inch/m  
 Distribution amplifier  
 Model number:  
 Switcher  
 Model number:  
 Adapter  
 Model number:

**Video equipment**  
 VCR, DVD player, Video camera, Video game or other  
 Manufacturer:  
 Model number:



## 10 TravelCare Guide

### TravelCare - a service for international travelers

This product is eligible for "TravelCare", NEC's unique international warranty.

Please note that TravelCare coverage differs in part from coverage under the warranty included with the product.

### Services offered with TravelCare

This warranty allows customers to receive service on their product at the NEC and NEC-designated service stations in the countries listed herein when temporarily traveling internationally for business or pleasure.

For details on services offered by the different service stations, please refer to the "List of TravelCare Outlets" below.

#### 1 Repair services

The product will be repaired and delivered within 10 business days, not including shipping time.

During the term of warranty, the cost of maintenance parts, labor costs for repairs and shipping costs within the service station's coverage area are covered by the warranty.

#### 2 Replacement product rental service

If the customer desires, he or she can rent a replacement product while the original product is being repaired.

Fee: US\$200 for 12 days

This fee must be paid at the local service station in cash or credit card.

The US\$200 rental fee is non-refundable even if the customer rents it less than 12 days before returning.

The replacement product will be delivered within 3 business days.

If the customer did not return the replacement product within 12 days,

the customer will be charged the price of the unit.

If the customer returned the replacement product in a faulty or damaged condition, the repair cost will be charged to the customer.

Note that this service is not offered in all countries and regions. Please refer to the "List of TravelCare Outlets".

In addition, this replacement product rental service is not offered after the product's warranty has expired.

### Term of warranty

1

- a. Upon presentation of the warranty or receipt received upon purchase:

Valid for the term indicated on the warranty or the normal term of warranty for the country of purchase.

- b. When only the product is brought in:

Valid for a period of within 14 months of the date of manufacture indicated by the serial number attached to the product.

- 2 When a product whose term of warranty is expired is brought in:

Repairs will be offered for a fee. In this case the customer is not eligible for the replacement product rental service.

- 3 In the following cases, repairs may be charged, even if the product's warranty is still in effect:

- 1) If the term of warranty, model name, serial number and name of the store of purchase are not indicated on the warranty or have been altered.
- 2) Problems or damage caused by dropping or shocks during shipment or movement by the customer or by improper handling by the customers.
- 3) Problems or damage caused by improper usage or unwarrantable alterations or repairs by the customer.
- 4) Problems or damage caused by fire, salt damage, gas damage, earthquakes, lightning damage, storm or flood damage or other natural disasters or such external factors as dust, cigarette smoke, abnormal voltage, etc.

- 5) Problems or damage caused by use in hot or humid places, in vehicles, boats or ships, etc.
- 6) Problems or damage caused by expendable supplies or devices connected to the product other than those designated by NEC.
- 7) Problems caused by natural consumption, wear or deterioration of parts under normal usage conditions.
- 8) Problems or damage to lamps and other expendable supplies, included parts or optional parts.
- 9) Other conditions stipulated in the warranty included with the product also apply.

**NOTE:** The product can be used overseas with voltages of 100 to 120V and 200 to 240V by using a power cable suited for the standards and power source voltage of the country in which the product is being used.

### List of TravelCare Outlets

This list applies as of April 1, 2007.

For the most up-to-date information, please refer to the websites of the service stations in the various countries on the List of TravelCare Outlets or to the NEC website at <http://www.nec-pj.com>.

#### In Europe

NEC Europe, Ltd. / European Technical Centre

Address: Unit G, Stafford Park 12, Telford TF3 3BJ, U.K.  
 Telephone: +44 1952 237000  
 Fax Line: +44 1952 237006  
 Email Address: [AFR@uk.neceur.com](mailto:AFR@uk.neceur.com)  
 WEB Address: <http://www.neceur.com>

(Regions Covered)

EU: Austria\*, Belgium\*, Denmark\*, Finland\*, France\*, Germany\*, Greece\*, Ireland\*, Italy\*, Luxembourg\*, The Netherlands\*, Portugal\*, Spain\*, Sweden\* and the United Kingdom\*

EEA: Norway\*, Iceland and Liechtenstein

#### In North America

NEC Display Solutions of America, Inc.

Address: 500 Park Boulevard, Suite 1100  
 Itasca, Illinois 60143, U.S.A.  
 Telephone: +1 800 836 0655  
 Fax Line: +1 800 356 2415  
 Email Address: [vsd.tech-support@necsam.com](mailto:vsd.tech-support@necsam.com)  
 WEB Address: <http://www.necdisplay.com/>

(Regions Covered)

U.S.A. \*, Canada\*

#### In Oceania

NEC Australia Pty., Ltd.

Address:  
 New South Wales;  
 184 Milperra Road, Reversby NSW 2212  
 Telephone: +61 2 9780 8688 Fax Line: +61 2 9780 8659  
 Victoria;  
 Unit 1/6 Garden Road, Clayton VIC 3168  
 Telephone: +61 3 8562 6245 Fax Line: +61 3 8562 6220  
 Newcastle;  
 120 Parry Street Newcastle West NSW 2300  
 Telephone: +61 2 4926 2466  
 Queensland;  
 Unit 4/305 Montague Road West End QLD 4101  
 Telephone: +61 7 3840 5858 Fax Line: +61 7 3840 5866  
 Goldcoast QLD;  
 Shop1 48 Ferry Road Southport QLD 4215  
 Telephone: +61 7 5591 3670  
 South Australia;  
 84A Richmond Road, Keswick SA 5035  
 Telephone: +61 8 8375 5707 Fax Line: +61 8 8375 5757  
 Western Australia;  
 45 Sarich Court Osborne Park WA 6017  
 Telephone: +61 8 9445 5901 Fax Line: +61 8 9445 5999

WEB Address: <http://www.nec.com.au>

(Regions Covered)  
Australia\*, New Zealand

### In Asia and Middle East

NEC Display Solutions, Ltd.

Address: 686-1, Nishioi, Oi-Machi, Ashigarakami-Gun,  
Kanagawa 258-0017, Japan  
Telephone: +81 465 85 2369  
Fax Line: +81 465 85 2393  
Email Address: support\_pjweb@nevt.nec.co.jp  
WEB Address: <http://www.nec-pj.com>

(Regions Covered)  
Japan\*

NEC Hong Kong Ltd.

Address: 25/F., The Metropolis Tower, 10 Metropolis Drive,  
Hung Hom, Kowloon, Hong Kong  
Telephone: +852 2369 0335  
Fax Line: +852 2795 6618  
Email Address: nechksc@nechk.nec.com.hk  
esmond\_au@nechk.nec.com.hk  
WEB Address: <http://www.nec.com.hk>

(Regions Covered)  
Hong Kong

NEC Taiwan Ltd.

Address: 7F, No.167, SEC.2, Nan King East Road, Taipei,  
Taiwan, R.O.C.  
Telephone: +886 2 8500 1714  
Fax Line: +886 2 8500 1420  
Email Address: chenguanfu@nec.com.tw  
WEB Address: <http://www.nec.com.tw>

(Regions Covered)  
Taiwan

NEC Solutions Asia Pacific Pte. Ltd

Address: 401 Commonwealth Drive, #07-02, Haw Par  
Technocentre, Singapore 149598  
Telephone: +65 6 273 8333  
Fax Line: +65 6 274 2226  
Email Address: tehgh@rsc.ap.nec.com.sg  
WEB Address: <http://www.nec.com.sg/ap>

(Regions Covered)  
Singapore

NEC Systems Integration Malaysia Sdn Bhd

Address: Ground Floor, Menara TA One, 22, Jalan P. Ramlee,  
50250 Kuala Lumpur, Malaysia  
Telephone: +6 03 2178 3600 (ISDN)  
Fax Line: +6 03 2178 3789  
Email Address: necare@nsm.nec.co.jp  
WEB Address: <http://www.necarecenter.com>

(Regions Covered)  
Malaysia

Hyosung ITX Co., Ltd.

Address: 2nd Fl., Ire B/D. #2, 4Ga, Yangpyeng-Dong,  
Youngdeungpo-Gu, Seoul, Korea 150-967  
Telephone: +82 2 2163 4193  
Fax Line: +82 2 2163 4196  
Email Address: moneybear@hyosung.com

(Regions Covered)  
South Korea

Lenso Communication Co., Ltd.

Address: 292 Lenso House 4, 1st Floor, Srinakarin Road,  
Huamark, Bangkok, Bangkok 10240, Thailand  
Telephone: +66 2 375 2425  
Fax Line: +66 2 375 2434  
Email Address: pattara@lenso.com  
WEB Address: <http://www.lenso.com>

(Regions Covered)  
Thailand

ABBA Electronics L.L.C.

Address: Tariq Bin Ziyad Road, P.O.Box 327, Dubai,  
United Arab Emirates  
Telephone: +971 4 371800  
Fax Line: +971 4 364283  
Email Address: ABBA@emirates.net.ae

(Regions Covered)  
United Arab Emirates

Samir Photographic Supplies

Address: P.O.Box 599, Jeddah 21421, Saudi Arabia  
Telephone: +966 2 6828219  
Fax Line: +966 2 6830820  
Email Address: asif@samir-photo.com

Riyadh

Address: P.O.Box 5519, Riyadh 11432, Saudi Arabia  
Telephone: +966 1 4645064  
Fax Line: +966 1 4657912  
Email Address: bhimji@samir-photo.com

Alkhubar

Address: P.O.Box 238, Alkhubar 31952, Saudi Arabia  
Telephone: +966 3 8942674  
Fax Line: +966 3 8948162  
Email Address: chamsedin@samir-photo.com

(Regions Covered)  
Saudi Arabia

---

**NOTE:** In countries designated with an asterisk(\*), replacement product rental service are offered.

---

Date: / / ,

P-1/ ,

**TO: NEC or NEC's Authorized Service Station:**

**FM:**

\_\_\_\_\_  
(Company & Name with signature)

Dear Sir (s),

I would like to apply your TravelCare Service Program based on attached registration and qualification sheet and agree with your following conditions, and also the Service fee will be charged to my credit card account, if I don't return the Loan units within the specified period. I also confirm following information is correct. Regards.

***Application Sheet for TravelCare Service Program***

Country, product purchased :	
User's Company Name :	
User's Company Address : Phone No., Fax No. :	
User's Name :	
User's Address :	
Phone No., Fax No. :	
Local Contact office :	
Local Contact office Address :	
Phone No., Fax No. :	
User's Model Name :	
Date of Purchase :	
Serial No. on cabinet :	
Problem of units per User :	
Required Service :	(1) Repair and Return      (2) Loan unit
Requested period of Loan unit :	
Payment method :	(1) Credit Card      (2) Travelers Cheque      (3) Cash
In Case of Credit Card : Card No. w/Valid Date :	

### Condition of your TravelCare Service Program

Enduser is requested to understand following condition of TravelCare Service Program and complete the necessary information on the application sheet.

#### 1. Service Options:

There are 3 types of "Service" available. Enduser has to understand following condition and is required to fill in the Application Sheet.

##### 1) Repair and Return:

The 'Faulty unit' is sent or collected from the customer. It is repaired and returned within 10 days to the customer, excluding transport time.

There may have a case, repair and return can't be done by NEC Authorized Service Station, because of shortage of spare parts due to same model is not sold in the territory.

##### 2) Repair and Return with Loan: (This service is limited to some Service Stations)

This service is offered to the Enduser, who cannot wait until their unit is repaired.

The customer can borrow a unit for \$200 up to 12 days. Customer then sends in inoperable unit to nearest NEC Authorized Service Station for service. In order to prevent collection problem, Enduser is required to fill in Application Sheet.

Enduser needs to confirm the availability of the Service to NEC Authorized Service Stations.

##### 3) Loan Only:

For this service, NEC Authorized Service Station supplies the customer with a loan unit for US\$200 up to 12 days. Customer keeps the inoperable unit and when customer returns home, customer arranges to have the projector serviced in the home country.

### 2. Warranty Exclusions:

This program does not apply if the Projector's serial number has been defaced, modified or removed.

If, in the judgement of NEC Authorized Service Station or its agent the defects or failures result from any cause other than fair wear and tear or NEC neglect, or fault including the following without limitation:

- 1) Accidents, transportation, neglect, misuse, abuse, water, dust, smoke or default of or by the Customer its employees or agents or any third party;
- 2) Failure or fluctuation of electrical power, electrical circuitry, air conditioning, humidity control or other environmental conditions such as use it in smoking area;
- 3) Any fault in the attachments or associated products or components (whether or not supplied by NEC or its agents which do not form part of the Product covered by this warranty);
- 4) Any act of God, fire, flood, war, act of violence or any similar occurrence;
- 5) Any attempt by any person other than any person authorized by NEC to adjust, modify, repair, install or service the product.
- 6) Any Cross-border charges such as, duty, insurance, tax etc.

### 3. Charges for Warranty Exclusions and Out of Warranty Case:

In case faulty unit is under warranty exclusions case or under Out of Warranty period, NEC Authorized Service Station will Inform estimation of actual service cost to the Enduser with reason.

### 4. Dead on Arrival (DOA):

Enduser must take this issue up with their original supplier in the country of purchase.

NEC Authorized Service Station will repair the DOA unit as a Warranty repair, but will not exchange DOA unit with new units.

### 5. Loan Service Charges and Conditions:

Upon acceptance of this NEC Projector, Customer agrees to assume liability for this loan unit.

The current cost of use of this loan unit is \$200.00 USD for 12 calendar days.

If Customer does not return the unit within the 12 calendar days, Customer will be charged the next highest cost up to and including the full list price to Credit Cards, which price will be informed by NEC Authorized Service Stations. Please see the attached listing of contacts for each country to arrange for pickup of the loan unit.

If you return to their country of origin with the loan unit, you will be charged additional freight to return the unit to the loaning country.

Thank you for your understanding of this program.