

Projector

PV800UL-W/PV800UL-B
PV710UL-W/PV710UL-B

User's Manual

Model No.

NP-PV800UL-W/NP-PV800UL-B/NP-PV710UL-W/NP-PV710UL-B

Table of Contents

Introduction	ii
Important Information	iii
1. Check the product overview, supplied items and part names	1
1-1. Introduction to the Projector	1
1-2. What's in the Box?	3
1-3. Part Names of the Projector	4
1-4. Part Names of the Remote Control	9
2. Projecting an Image (Basic Operation)	16
2-1. Flow of Projecting an Image	16
2-2. Connecting Your Computer/Connecting the Power Cord	17
2-3. Turning on the Projector	19
2-4. Selecting a Source	22
2-5. Adjusting the Picture Size and Position	24
2-6. Adjusting a picture and sound	34
2-7. Turning off the Projector	35
2-8. After Use	36
3. Appendix	37
3-1. Specifications	37
3-2. Troubleshooting	40
3-3. Mounting a lens (sold separately)	45
3-4. REGISTER YOUR PROJECTOR! (for residents in the United States, Canada, and Mexico)	49

Introduction

Thank you for purchasing the NEC projector.

This projector can be connected to computers, video devices, etc. to project images sharply onto a screen.

Please read this manual carefully before using your projector.

Read this manual if you have any doubts about operation or if you believe the projector may be faulty.

The Installation Manual provides detailed instructions on installation, adjustments, maintenance, etc., is posted on our website.

https://www.sharp-nec-displays.com/dl/en/pj_manual/lineup.html

NOTES



- (1) The contents of this manual may not be reprinted in part or whole without permission.
- (2) The contents of this manual are subject to change without notice.
- (3) Great care has been taken in the preparation of this manual; however, should you notice any questionable points, errors or omissions, please contact us.
- (4) The image shown in this manual is indicative only. If there is inconsistency between the image and the actual product, the actual product shall govern.
- (5) Notwithstanding article (3) and (4), we will not be responsible for any claims on loss of profit or other matters deemed to result from using this device.
- (6) This manual is commonly provided to all regions so they may contain descriptions that are pertinent for other countries.

Important Information









About the symbols

To ensure safe and proper use of the product, this manual uses a number of symbols to prevent injury to you and others as well as damage to property.

The symbols and their meanings are described below. Be sure to understand them thoroughly before reading this manual.

 WARNING	Failing to heed this symbol and handling the product erroneously could result in accidents leading to death or major injury.
 CAUTION	Failing to heed this symbol and handling the product erroneously could result in personal injury or damage to surrounding property.

Examples of symbols

	This symbol indicates you should be careful of electric shocks.
	This symbol indicates you should be careful of high temperatures.
	This symbol indicates something that must be prohibited.
	This symbol indicates something that must not be got wet.
	This symbol indicates you should not touch with wet hands.
	This symbol indicates something that must not be disassembled.
	This symbol indicates things you must do.
	This symbol indicates that the power cord should be unplugged from the power outlet.

Safety Cautions

WARNING

Projected light



PROHIBITED

Projected light and the pictogram/label indicated on the cabinet

- Do not look into the projector's lens. Strong light that could damage your vision is projected when the projector is operating. Laser energy exposure near aperture may cause burns. Be especially careful when children are around.
- Do not look at the projected light using optical devices (magnifying glasses, reflectors, etc.). Doing so could result in vision impairment.
- Check that there is no one looking at the lens within the projection range before turning on the projector.
- Do not allow children to operate the projector alone. When a child is operating the projector an adult should always be present and watch the child carefully.
- The below pictogram, that is indicated near the lens on the cabinet, describes looking into the projector is prohibited.

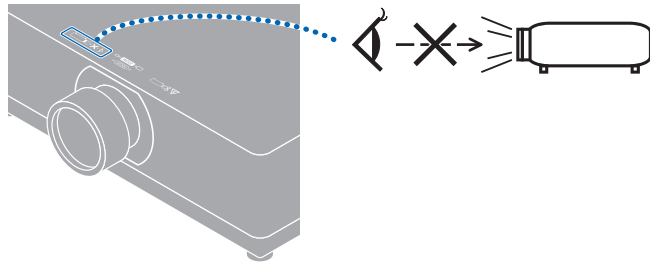

Continue to next page

⚠ WARNING

- The following labels are stuck on the projector.

Label 1
Laser explanatory label



This product complies with EN 50689:2021 except using the lens of NP15ZL and NP43ZL.

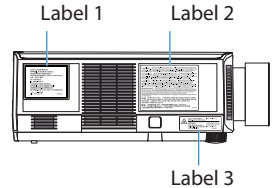

Label 2
Lens replacement caution label

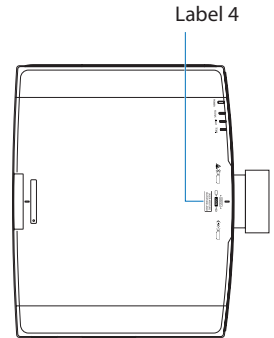
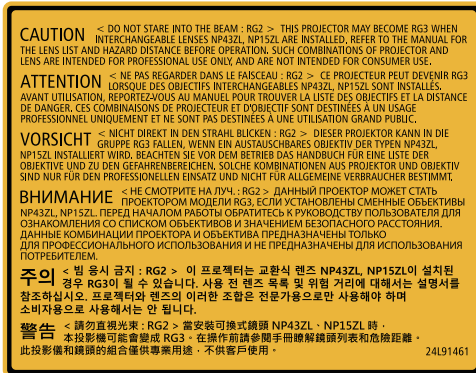

Label 3
Laser explanatory label for USA



Label 4
Laser aperture label



- [For regions other than USA]
This projector is classified as either IEC/EN 62471-5:2015 risk group 2 or risk group 3 depending on the lens unit.
When classified as risk group 3, this projector is intended for professional use and must be installed by professional installer to ensure safety.
See page [xvi](#) for risk groups.
[For USA]
There are no installation restrictions.
- See Page [xiii](#) for Laser Safety Caution.

 **WARNING**

Power supply



REQUIRED

Use a suitable voltage power supply.

- This projector is designed to be used with a 100–240 V AC, 50/60 Hz power supply. Before using the projector, check that the power supply to which the projector is to be connected meets these requirements.
- Use a power outlet as the projector's power supply. Do not connect the projector directly to electrical light wiring. Doing so is dangerous.



REQUIRED

Handling the power cord

- Please use the power cord supplied with this projector. If the supplied power cord does not satisfy requirements of your country's safety standard, and voltage and current for your region, make sure to use the power cord that conforms to and satisfies them.

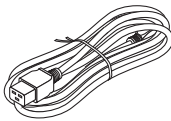

- The power cord you use must be approved by and comply with the safety standards of your country. Please refer to the page 38 about the power cord specification.
For selecting an appropriate power cord, please check rated voltage for your region by yourself.



PROHIBITED



**HAZARDOUS
VOLTAGE**

- The power cord included with this projector is exclusively for use with this projector. For safety, do not use it with other devices.
- Handle the power cord with care. Damaging the cord could lead to fire or electric shock.
 - Do not place heavy objects on the cord.
 - Do not place the cord under the projector.
 - Do not cover the cord with a rug, etc.
 - Do not scratch or modify the cord.
 - Do not bend, twist or pull the cord with excessive force.
 - Do not apply heat to the cord.
 Should the cord be damaged (exposed core wires, broken wires, etc.), ask your dealer to replace it.
- Do not touch the power plug should you hear thunder. Doing so could result in electric shock.

 **WARNING**

Installation



PROHIBITED



DO NOT WET



**UNPLUG THE
POWER CORD**

Do not use in places such as those described below.

- Do not use in places such as those described below. Doing so could lead to fire or electric shock.
 - Shaky tables, inclined surfaces or other unstable places
 - Near heating appliances or places with heavy vibrations
 - Outdoors or humid or dusty places
 - Places exposed to oil smoke or steam
 - Near cooking appliances, humidifiers, etc.
 - Do not use in places such as those described below where the projector could get wet. Doing so could lead to fire or electric shock.
 - Do not use in the rain or snow, on a seashore or waterfront, etc.
 - Do not use in a bathroom or shower room.
 - Do not place vases or potted plants on the projector.
 - Do not place cups, cosmetics or medicines on the projector.
- Should water, etc. get inside the projector, first turn off the projector's power, then unplug the power cord from the power outlet and contact your dealer.



CAUTION

Installing suspended from the ceiling

- Consult your dealer for installing the projector on the ceiling. Special skills are required for ceiling installation.
DO NOT perform installation work by people other than installers. Doing so may result in the projector falling and causing injury.
- We are not liable for any accident or/and damage resulting from improper installation or handling, misuse, modification, or natural disasters.
- When installed suspended from the ceiling, etc. do not hang from the projector. The projector could drop and cause injury.
- When installing suspended from the ceiling, use a power outlet that is within reach so the power cord can be easily plugged and unplugged.

On use



PROHIBITED











**UNPLUG THE
POWER CORD**

Do not place objects inside the projector.

- Do not insert or drop metal or combustible objects or other foreign materials into the projector from the vents. Doing so could lead to fire or electric shock. Be particularly careful if there are children in the home. Should a foreign object get inside the projector, first turn off the projector's power, then unplug the power cord from the power outlet and contact your dealer.

 **WARNING**

 <p>UNPLUG THE POWER CORD</p>	<p>Unplug the power cord if the projector malfunctions.</p> <ul style="list-style-type: none"> Should the projector emit smoke or strange odors or sounds, or if the projector has been dropped or the cabinet broken, turn off the projector's power, then unplug the power cord from the power outlet. It may cause not only fire or electric shock but also serious damage to your eyesight or burns. Contact your dealer for repairs. Never try to repair the projector on your own. Doing so is dangerous.
 <p>DO NOT DISASSEMBLE</p>	<p>Do not disassemble the projector.</p> <ul style="list-style-type: none"> Do not remove or open the projector's cabinet. Also, do not modify the projector. There are high voltage areas in the projector. It may cause fire, electric shock, or laser light leakage, resulting in serious damage to your eyesight or burns. Have qualified service personnel perform inspection, adjustments and repairs of the interior.
 <p>PROHIBITED</p>  <p>CAUTION FOR HIGH TEMPERATURE</p>	<p>Do not place objects in front of the lens while the projector is operating.</p> <ul style="list-style-type: none"> Do not leave the lens cap on the lens while the projector is operating. The lens cap could get hot and be warped. Do not place objects in front of the lens that obstruct the light while the projector is operating. The object could get hot and be broken or catch fire. The below pictogram indicated on the cabinet means the precaution for avoiding to place objects in front of the projector lens. 
 <p>PROHIBITED</p>	<p>When cleaning the projector</p> <ul style="list-style-type: none"> Do not use flammable gas sprays to remove dust from the lens, cabinet, etc. Doing so could lead to fire.
 <p>REQUIRED</p>  <p>PROHIBITED</p>	<p>About cable cover (separately sold)</p> <ul style="list-style-type: none"> Be sure to tighten the screws after attaching the cable cover. Failure to do so may cause the cable cover to come off and fall, resulting in injury or damage to the cable cover. Do not put bundled cables in the cable cover. Doing so may damage the power cord, resulting in a fire. Do not hold the cable cover while moving the projector or do not apply excessive force to the cable cover. Doing so may damage the cable cover, resulting in injury.

 **WARNING**



PROHIBITED

Do not use in high security locations.

- Usage of the product must not be accompanied by fatal risks or dangers that, could lead directly to death, personal injury, severe physical damage or other loss, including nuclear reaction control in nuclear facility, medical life support system, and missile launch control in a weapon system.

 **CAUTION**

Power supply



REQUIRED

Connecting the power cord to earth

- This equipment is designed to be used in the condition of the power cord connected to earth. If the power cord is not connected to the earth, it may cause electric shock. Please make sure the power cord is connected to the wall outlet directly and earthed properly.
Do not use a 2-pin plug converter adapter.
- Be sure to connect the projector and the computer (signal source) to the same earth point. If the projector and the computer (signal source) will be connected to different earth points, fluctuations in the earth potential may cause fire or smoke.



REQUIRED









**DO NOT TOUCH
WITH WET
HANDS**







**UNPLUG THE
POWER CORD**

Handling the power cord

- When connecting the power cord to the projector's AC IN terminal, make sure the connector is fully and firmly inserted. Be sure to fix the power cord using the power cord stopper. Loose connection of the power cord could lead to fire or electric shock.
- Do not connect or disconnect the power cord with wet hands. Doing so could result in electric shock.
- When cleaning the projector, for safety purposes unplug the power cord from the power outlet beforehand.
- When moving the projector, first be sure to turn off the power, unplug the power cord from the power outlet and check that all connection cables connecting the projector to other devices have been disconnected.
- When planning not to use the projector for long periods of time, always unplug the power cord from the power outlet.

 CAUTION	
Installation	
 REQUIRED	<p>Securing the lens unit with the fall prevention wire</p> <ul style="list-style-type: none"> • If the projector is going to be suspended from a ceiling or another high place, secure the lens unit using the fall prevention wire (sold separately). If the lens unit is not secured, it may fall down if it comes loose.
On use	
 PROHIBITED	<p>Do not use on networks subject to overvoltage.</p> <ul style="list-style-type: none"> • Connect the projector's Ethernet/HDBaseT port and LAN port to a network for which there is no risk of overvoltage being applied. Overvoltage applied to the Ethernet/HDBaseT or LAN port could result in electric shock.
 REQUIRED	<p>Lens shift, focus and zoom operations</p> <ul style="list-style-type: none"> • When shifting the lens or adjusting the focus or zoom, do so from either behind or the side of the projector. If adjustments are performed from the front, your eyes could be exposed to strong light and get injured. • Keep your hands away from the lens area when performing the lens shift operation. If not, your fingers could get caught in the gap between the cabinet and the lens.
 PROHIBITED	<p>Handling batteries</p> <ul style="list-style-type: none"> • Handle batteries with caution. Failure to do so could lead to fire, injury or contamination of the surroundings. <ul style="list-style-type: none"> - Do not short-circuit or take apart batteries or dispose of them in flames. - Do not use batteries other than those specified. - Do not use new batteries together with old ones. - When inserting batteries, pay attention to the polarities (+ and – directions), and be sure to insert them as indicated. • Contact your dealer or local authorities when disposing of batteries.
 PROHIBITED  CAUTION FOR HIGH TEMPERATURE	<p>About the vents</p> <ul style="list-style-type: none"> • Do not obstruct the projector's vents. Also, do not place such soft objects as paper or cloths underneath the projector. Doing so could lead to fire. Leave sufficient space between the place where the projector is installed and its surroundings. (→ page xxvii) • Do not touch the exhaust vent area while projecting or immediately after projecting images. The exhaust vent area may be hot at this time and touching it could cause burns.

 **CAUTION**

 PROHIBITED	<p>Moving the projector</p> <ul style="list-style-type: none"> • When moving the projector, do not hold the lens section. The focus ring could turn, causing the projector to drop and resulting in injury. Also, if you put your hand on the gap between the cabinet and the lens, the projector may be damaged, falling and causing injury. • When carrying the projector with the lens unit removed, do not touch the mounting area of the lens with your hands. Also, do not put your hand into the recess of the connection terminal. The projector could be damaged or fall down, resulting in injuries. Do not carry the projector by holding the recessed area that is exposed after the filter cover has been removed. Doing so could damage the cabinet, and the projector could fall and cause an injury. • When moving the projector with the cable cover attached, do not hold it by the cable cover. The cable cover could come loose and the main unit could fall down, causing injuries.
 REQUIRED	<p>Attaching/detaching the lens</p> <ul style="list-style-type: none"> • Turn off the projector and disconnect the power cord before attaching or detaching the lens unit. Failure to do so could result in visual impairment or burns.
 REQUIRED	<p>Avoid locations with extreme temperatures and humidity</p> <ul style="list-style-type: none"> • Failure to do so could lead to fire or electric shock or damage to the projector. The usage environment for this projector is as follows: <ul style="list-style-type: none"> - The operating temperature: 0°C to 45°C / 32°F to 113°F / humidity: 20 to 80% (without condensation) - The storage temperature: -10°C to 50°C / 14°F to 122°F / humidity: 20 to 80% (without condensation)
<p>Inspections and Cleaning</p>	
 REQUIRED	<p>Inspecting the projector and cleaning the inside</p> <ul style="list-style-type: none"> • Consult with your dealer about once per year for cleaning of the inside of the projector. Dust could accumulate inside of the projector if it is not cleaned for extended periods of time, leading to fires or malfunction.

Laser Safety Caution

For USA

 **WARNING - CLASS 3R OF IEC 60825-1:2007 LASER PRODUCT**

LASER RADIATION - AVOID DIRECT EYE EXPOSURE

- Use of controls or adjustments or performance of procedures other than those specified herein may result in hazardous radiation exposure.
-
- This product is classified as Class 3R of IEC 60825-1:2007
Complies with FDA performance standards for laser products except for deviations pursuant to Laser Notice No. 50, dated June 24, 2007.

For regions other than USA

 **WARNING**

CLASS 1 LASER PRODUCT [IEC 60825-1:2014]

CLASS 1 CONSUMER LASER PRODUCT OF EN 60825-1:2014+A11:2021 (For EU and UK)

- The laser module is equipped in this product. Use of controls or adjustments of procedures other than those specified herein may result in hazardous radiation exposure.
Laser energy exposure near aperture may cause burns.
-
- This product is classified as Class 1 of IEC 60825-1:2014.
 - For EU and UK, EN 60825-1:2014+A11:2021 and EN 50689:2021 are also conformed.
Except using the lens of NP15ZL and NP43ZL.
 - Obey the laws and regulations of your country in relation to the installation and management of the device.
-
- Outline of laser emitted from the built-in light module:
 - Wave length: 455 nm
 - Maximum power: 176 W (PV800UL-W/PV800UL-B), 154 W (PV710UL-W/PV710UL-B)
 - Radiation pattern from the protective housing:
 - Wave length: 455 nm
 - Maximum laser radiation output: 333 mW

Light Module

- A light module containing multiple laser diodes is equipped in the product as the light source.
- These laser diodes are sealed in the light module. No maintenance or service is required for the performance of the light module.
- End user is not allowed to replace the light module.
- Contact qualified distributor for light module replacement and further information.

Laser light radiation range

The figure below shows the maximum radiation range of the laser light.

Horizontal angle (unit: degree)

Lens unit	Zoom	Lens position		
		Right most	Center (Reference value)	Left most
		HR	HC	HL
NP11FL		31.8	31.8	31.8
NP12ZL	Tele	27.4	18.0	27.4
	Wide	34.0	22.9	34.0
NP13ZL	Tele	15.1	9.6	15.1
	Wide	28.3	18.6	28.3
NP14ZL	Tele	9.6	6.0	9.6
	Wide	15.1	9.6	15.1
NP15ZL	Tele	6.4	4.0	6.4
	Wide	9.7	6.1	9.7
NP40ZL	Tele	31.7	23.8	31.7
	Wide	41.0	31.8	41.0
NP41ZL	Tele	13.0	9.4	13.0
	Wide	27.9	20.7	27.9
NP43ZL	Tele	6.8	4.9	6.8
	Wide	13.4	9.7	13.4
NP50ZL	Tele	42.0	32.7	42.0
	Wide	48.2	38.6	48.2

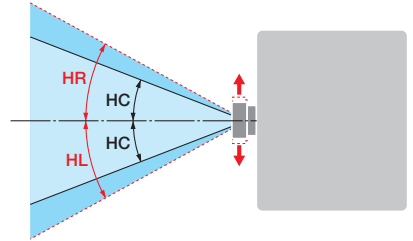

Vertical angle (unit: degree)

Lens unit	Zoom	Lens position		
		Upper most	Center (Reference value)	Lower most
		VU	VC	VD
NP11FL		21.2	21.2	21.2
NP12ZL	Tele	24.0	11.5	13.7
	Wide	30.1	14.8	17.6
NP13ZL	Tele	13.0	6.0	7.2
	Wide	24.8	11.9	14.1
NP14ZL	Tele	8.3	3.8	4.5
	Wide	13.1	6.0	7.2
NP15ZL	Tele	5.5	2.5	3.0
	Wide	8.4	3.8	4.6
NP40ZL	Tele	28.9	15.4	18.3
	Wide	37.8	21.2	24.9
NP41ZL	Tele	11.6	5.9	7.0
	Wide	25.3	13.3	15.8
NP43ZL	Tele	6.1	3.0	3.7
	Wide	12.0	6.1	7.3
NP50ZL	Tele	38.8	21.9	25.7
	Wide	44.9	26.5	30.9

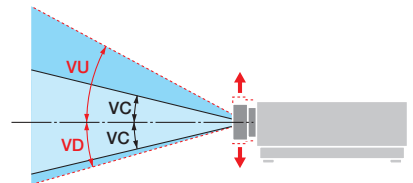

Horizontal angle (unit: degree)

Lens unit	Zoom	
	Tele	Wide
NP44ML	—	55.8

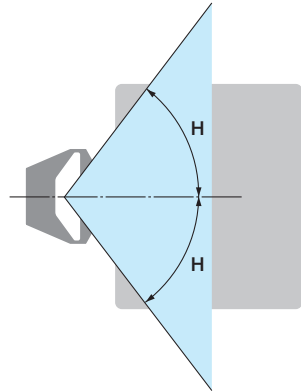

Vertical angle (unit: degree)

Lens unit	Zoom		
	Tele	V1	V2
NP44ML	—	10.7	24.6

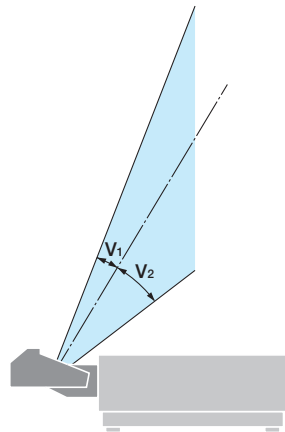

Risk groups (for regions other than USA)

This projector is classified as either IEC/EN 62471-5:2015 risk group 2 or risk group 3 depending on the lens unit.

Risk group 2 (RG2)

 **WARNING**

As with any bright light source, do not stare into the beam, RG2 IEC/EN 62471-5:2015.

Risk group 3 (RG3)

 **WARNING**

RG3 PRODUCT OF IEC/EN 62471-5:2015

- When classified as RG3, this projector is for professional use and must be installed in location where safety is assured. For this reason, be sure to consult your dealer as installation must be performed by a professional installer. Never try to install the projector by yourself. This may result in visual impairment etc.
- No direct exposure to the beam shall be permitted, RG3 IEC/EN 62471-5:2015.
- Do not look into the projector's lens. Serious damage to your eyes could result.
- Operators shall control access to the beam within the hazard distance or install the product at the height that will prevent exposures of spectators' eyes within the hazard distance.
- When turning on the power, operate from the side or rear of the projector (outside the hazard zone). Also, when turning on the power, make sure no one within the projection range is looking at the lens.

• Check before installing the projector

① Lens model name

The lens unit model is listed at one of the locations in ■■■ in the images below.

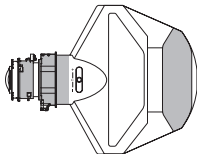
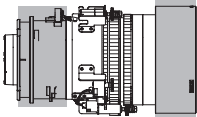
Diagram of NP44ML	Diagram of non-NP44ML models
 <p>A technical drawing of the NP44ML lens unit, showing a cylindrical front section with a lens and a larger, flared rear section.</p>	 <p>A technical drawing of a non-NP44ML lens unit, showing a more complex assembly with multiple internal components and a rectangular housing.</p>

② Combining with Risk group 3 category products

Projector model name	Lens model name
PV800UL-W/PV800UL-B/PV710UL-W/PV710UL-B	NP15ZL, NP43ZL

• Hazard zone

The below figure describes the radiation zone (hazard zone) of light emitted by the projector that is classified as Risk Group 3 (RG3) of IEC/EN 62471-5:2015.

Overhead view

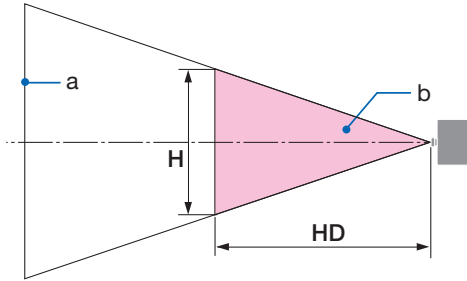

a: Screen / b: Hazard zone

Side view

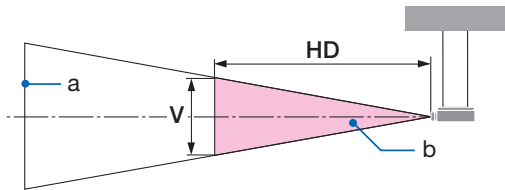

a: Screen / b: Hazard zone

PV800UL-W/PV800UL-B

Lens		Hazard zone (m)		
		HD	H	V
NP15ZL	Wide	1.0	0.25	0.16
	Tele	1.5	0.23	0.15
NP43ZL	Wide	0.7	0.26	0.16
	Tele	1.4	0.24	0.16

PV710UL-W/PV710UL-B

Lens		Hazard zone (m)		
		HD	H	V
NP15ZL	Wide	0.9	0.23	0.14
	Tele	1.3	0.21	0.13
NP43ZL	Wide	0.7	0.23	0.15
	Tele	1.2	0.21	0.13

• About the precautionary zone

By providing a precautionary zone or physical barriers, it is possible to prevent human eyes from entering the hazard zone.

When the manager of the projector (operator) cannot prevent spectators from entering the hazard zone such as in public facilities, it is recommended to secure a space of 1 m or more from the hazard zone as “the precautionary zone” for the safety of the spectators. When installing the projector overhead, it is recommended that the distance between the floor and the hazard zone be at least 3 m in the vertical direction.

• Installation example considering the precautionary zone

① Floor or desktop installation example

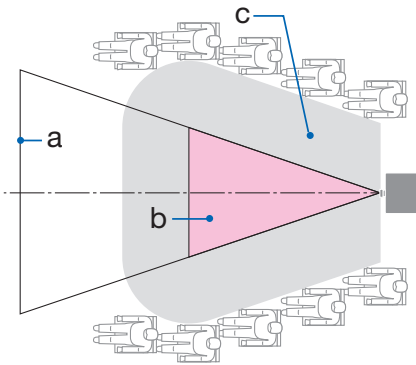

② Ceiling installation example

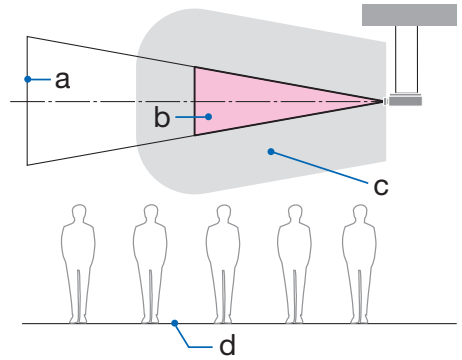

a: Screen / b: Hazard zone / c: Precautionary zone / d: floor



If it is expected that spectators will intrude into the hazard zone when installed on the ceiling, it is necessary to prevent spectators from entering that area.

③ **Example of downward projection installed on the ceiling**

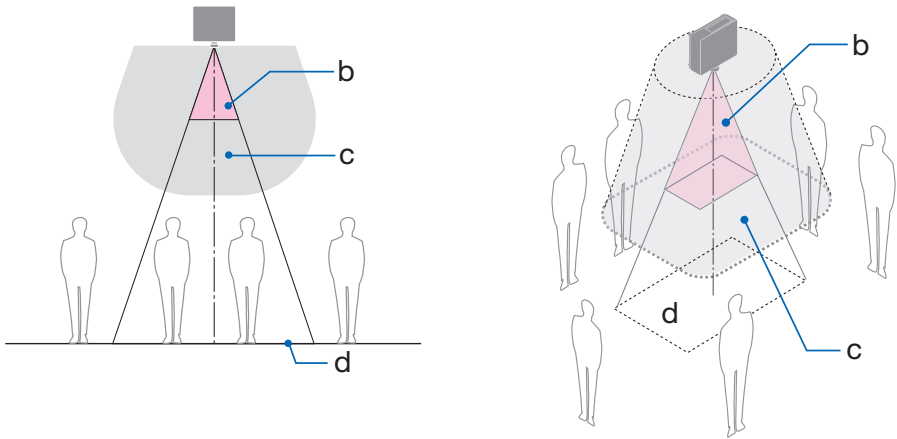

a: Screen / b: Hazard zone / c: Precautionary zone / d: floor

 <p>CAUTION</p>	<p>If the precautionary zone between the floor and the hazard zone cannot be secured, it is necessary to prevent spectators from entering the area around the screen as shown in the figure on the right.</p>
---	---

* If using lens shift, please consider the shift of projected image according to the volume of lens shift. Installation example considering the precautionary zone



Please follow all safety precautions.

Installing the projector

- When planning the layout of the projector, make sure to follow the safety measures listed in the installation manual.
- In order to avoid danger, either install the device within easy reach of a wall outlet or provide a device like a breaker to disconnect power to the projector in emergency.
- Take safety measures to prevent human eyes from entering the hazard zone.
- Select an appropriate lens for the installation location and secure the safety zone set for each lens.
Ensure that appropriate safety measures have been taken when operating the projector, adjusting the light, etc.
- Check whether the appropriate safety zone for the installed lens has been adequately secured. Periodically check the zone and maintain a record of verifications.

The installer or dealer must instruct the manager (operator) of the projector of the following:

- Educate the manager of the projector (operator) about safety before operating the projector.
- Instruct the manager of the projector (operator) to perform inspections (Including safety checks on light emitted by the projector) before powering the projector on.
- Instruct the manager of the projector (operator) to be able to control the projector whenever the projector is powered on in case of an emergency.
- Instruct the manager of the projector (operator) to keep the installation manual, user's manual and inspection records in an easy-to-reach place.
- Instruct them to determine whether the projector conforms to the standards of each country and region.

Cable information

Use shielded cables or cables attached ferrite cores so as not to interfere with radio and television reception.

FCC Information (for USA only)

WARNING

- The Federal Communications Commission does not allow any modifications or changes to the unit EXCEPT those specified by Sharp NEC Display Solutions of America, Inc. in this manual. Failure to comply with this government regulation could void your right to operate this equipment.
- This equipment has been tested and found to comply with the limits for a class A digital device, pursuant to Part 15 of the FCC Rules. These limits are designed to provide reasonable protection against harmful interference when the equipment is operated in a commercial environment. This equipment generates, uses, and can radiate radio frequency energy and, if not installed and used in accordance with the instruction manual, may cause harmful interference to radio communications. Operation of this equipment in a residential area is likely to cause harmful interference in which case the user will be required to correct the interference at his own expense.

Supplier's declaration of conformity

This device complies with Part 15 of the FCC Rules. Operation is subject to the following two conditions.

(1) This device may not cause harmful interference, and (2) this device must accept any interference received, including interference that may cause undesired operation.

U.S.Responsible Party: Sharp NEC Display Solutions of America, Inc.
Address: 3250 Lacey Rd, Ste 500
Downers Grove, IL 60515
Telephone Number: 630-467-3000
Type of Product: Projector
Equipment Classification: Class A Peripheral
Model Number: NP-PV800UL-W/NP-PV800UL-B/NP-PV710UL-W/NP-PV710UL-B



Notice Concerning Electromagnetic Interference (EMI) (For other regions)

WARNING:

Operation of this equipment in a residential environment could cause radio interference.

(For Customers in U.K.)

IMPORTANT

- The wires in this mains lead are coloured in accordance with the following code:

GREEN-AND-YELLOW:	“Earth”
BLUE:	“Neutral”
BROWN:	“Live”

- As the colours of the wires in the mains lead of this apparatus may not correspond with the coloured markings identifying the terminals in your plug proceed as follows:
- The wire which is coloured GREEN-AND-YELLOW must be connected to the terminal in the plug which is marked by the letter **E** or by the safety earth symbol \perp or coloured green or green-and-yellow.
- The wire which is coloured BLUE must be connected to the terminal which is marked with the letter **N** or coloured black.
- The wire which is coloured BROWN must be connected to the terminal which is marked with the letter **L** or coloured red.
- Ensure that your equipment is connected correctly. If you are in any doubt consult a qualified electrician.

“WARNING: THIS APPARATUS MUST BE EARTHED.”



Disposing of your used product



In the European Union

EU-wide legislation as implemented in each Member State requires that used electrical and electronic products carrying the mark (left) must be disposed of separately from normal household waste. This includes the projector or electrical accessory, such as a power cord. When you dispose of such products, please follow the guidance of your local authority and/or ask the shop where you purchased the product.

After collecting the used products, they are reused and recycled in a proper way. This effort will help us reduce the wastes as well as the negative impact to the human health and the environment at the minimum level.

The mark on the electrical and electronic products only applies to the current European Union Member States.

Outside the European Union

If you wish to dispose of used electrical and electronic products outside the European union, please contact your local authority and ask for the correct method of disposal.



For EU: The crossed-out wheeled bin implies that used batteries should not be put to the general household waste! There is a separate collection system for used batteries, to allow proper treatment and recycling in accordance with legislation.

According the EU directive 2006/66/EC, the battery can't be disposed improperly. The battery shall be separated to collect by local service.

(for Germany only)

Machine Noise Information Regulation - 3. GPSGV,

The highest sound pressure level is less than 70 dB (A) in accordance with EN ISO 7779.

Information of the AUDIO OUT mini jack

The AUDIO OUT mini jack does not support earphone/headphone terminal.

Notes on installation and maintenance

Do not install or store in such places as those described below.

- Locations that amplify vibrations and impacts
If installed in places where the vibrations from power sources and the like are conveyed, or in vehicles or on vessels, etc. the projector could be affected by vibrations or shocks that may damage internal parts and lead to malfunction.
- Close to high voltage power lines and power sources
It could disrupt the unit.
- Places where strong magnetic fields are generated
Doing so could lead to malfunction.
- Outdoors and places with humid or dust
Places exposed to oil smoke or steam
Places where corrosive gases are generated
Attached substances such as oil, chemicals and moisture may cause deformation or cracks of the cabinet, corrosion of the metal parts, or malfunction.

To the dealer and the installer

When installing the projector, please see the Installation Manual provided on our web site.

1. To prevent the projector from falling, install it on the ceiling in a way with sufficient strength to withstand the combined weight of the projector and the ceiling mount unit for an extended period of time.
2. When installing the projector on the ceiling, be sure to do so correctly in accordance with the installation manual for the Ceiling Mount Unit. Be sure to use the fixed metal fittings and to tighten the screws securely.
3. To prevent the projector from falling, use fall prevention wires.
 - Use commercially available metal fittings to join the robust part of a building or construction and the security bar of the projector with the fall prevention wires.
 - Use commercially available metal fittings and fall prevention wires that have sufficient strength to withstand the combined weight of the projector and the ceiling mount unit.
 - Slightly slack off the fall prevention wires so as not to put a load on the projector.
 - Refer to the "Part Names of the Projector" for the location of the security bar. (→ page 4)

Cautions for ensuring the projector's performance

- If intense light like laser beams enters from the lens, it could lead to malfunction.
- Consult your dealer before using in places where much cigarette smoke or dust is present.
- When the same still image is projected for a long period of time with a computer, etc. the pattern of the image may remain on the screen after the projection is stopped, but it will disappear after a while. This happens due to the properties of liquid crystal panels, and is not a malfunction. We recommend using a screensaver on the computer side.
- When using the projector at altitudes of about 5500 feet/1600 meters or higher, be sure to set the [FAN MODE] to [HIGH ALTITUDE]. If not, the inside of the projector may get hot, leading to malfunction.
- When the projector is used at high altitudes (places where the atmospheric pressure is low), it may be necessary to replace the optical parts sooner than usual.
- About moving the projector
 - Detach the lens unit once, and be sure to attach the lens cap so as not to scratch the lens. Also, attach a dust protective cap to the projector.
 - Do not subject the projector to vibrations or strong shocks.
The projector could be damaged otherwise.
- Do not use the tilt feet for purposes other than adjusting the projector's tilt.
Improper handling, such as carrying the projector by the tilt feet or using it leaned against a wall, could lead to malfunction.
- Do not touch the surface of the projection lens with bare hands.
Fingerprints or dirt on the surface of the projection lens will be enlarged and projected on the screen. Do not touch the surface of the projection lens.
- Do not unplug the power cord from the projector or the power outlet while projecting. Doing so could cause deterioration of the projector's AC IN terminal or power plug contact. To interrupt the AC power supply while images are being projected, use a breaker, etc.
- About handling of the remote control
 - The remote control will not work if the projector's remote signal sensor or the remote control's signal transmitter is exposed to strong light or if there are obstacles between them that obstruct the signals.
 - Operate the remote control from within 20 meters from the projector, pointing it at the projector's remote signal sensor.
 - Do not drop the remote control or handle it improperly.
 - Do not let water or other liquids get on the remote control. Should the remote control get wet, wipe it off immediately.
 - Avoid using in hot and humid places as far as possible.
 - When planning not to use the remote control for long periods of time, remove both batteries.
- Take measures to prevent external light from shining on the screen.
Make sure only the light from the projector shines on the screen. The less external light on the screen, the higher the contrast and the more beautiful the images.
- About screens
Images will not be clear if there is dirt, scratches, discoloration, etc. on your screen. Handle the screen with care, protecting it from volatile substances, scratches and dirt.
- Concerning to all maintenance operations, refer to Installation Manual and follow all instructions properly.

Clearance for Installing the Projector

- When installing the projector, keep sufficient space around it, as described below. If not, the hot exhaust emitted from the projector may be taken back in. Also, make sure no wind from an air-conditioner hits the projector. The projector's heat control system may detect an abnormality (temperature error) and automatically shut off the power.

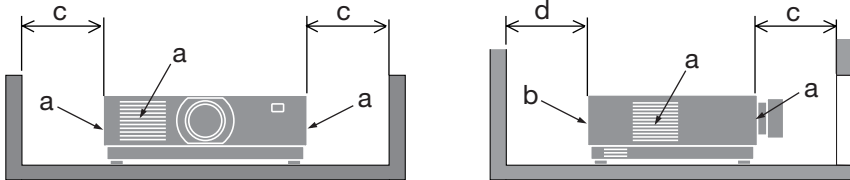

a: Intake vent / b: Exhaust vent / c: 20 cm/8" or greater / d: 30 cm/12" or greater

NOTE:

- In the above figure, it is assumed that there is sufficient space above the projector.
- When using multiple projectors together, provide sufficient space around the projectors for air intake and exhaust. When the intake and exhaust vents are obstructed, the temperature inside the projector will rise and this may result in a malfunction.



About Copyright of original projected pictures:

Please note that using this projector for the purpose of commercial gain or the attraction of public attention in a venue such as a coffee shop or hotel and employing compression or expansion of the screen image with the following functions may raise concern about the infringement of copyrights which are protected by copyright law.

[ASPECT RATIO], [KEYSTONE], Magnifying feature and other similar features.

Power management function

The projector has power management functions. To reduce power consumption, the power management functions (1 and 2) are factory preset as shown below. To control the projector from an external device via a LAN or serial cable connection, use the on-screen menu to change the settings for 1 and 2.

1. STANDBY MODE (Factory preset: NORMAL)

To control the projector from an external device, select [NETWORK STANDBY] or [SLEEP] for [STANDBY MODE].

2. AUTO POWER OFF (Factory preset: 1 hour)

To control the projector from an external device, select [OFF] for [AUTO POWER OFF].

Registration Information and Software License

- ProAssist and Virtual Remote are trademarks or registered trademarks of Sharp NEC Display Solutions, Ltd. in Japan, in the United State and other countries.
- The terms HDMI, HDMI High-Definition Multimedia Interface, HDMI Trade Dress and the HDMI Logos are trademarks or registered trademarks of HDMI Licensing Administrator, Inc.



- HDBaseT™ and the HDBaseT Alliance logo are trademarks of the HDBaseT Alliance.



- Trademark PJLink is a trademark applied for trademark rights in Japan, the United States of America and other countries and areas.
- Blu-ray is a trademark of Blu-ray Disc Association.
- CRESTRON and CRESTRON ROOMVIEW are trademarks or registered trademarks of Crestron Electronics, Inc. in the United States and other countries.
- Extron and XTP are registered trademarks of RGB Systems, Inc. in the United States.
- Ethernet is either a registered trademark or trademark of FUJIFILM Business Innovation Corp.
- Other product and company names mentioned in this manual may be the trademarks or registered trademarks of their respective holders.
- Virtual Remote Tool uses WinI2C/DDC library, © Nicomsoft Ltd.
- GPL/LGPL Software Licenses

The product includes software licensed under GNU General Public License (GPL), GNU Lesser General Public License (LGPL), and others.

For more information on each software, visit our web site.

https://www.sharp-nec-displays.com/dl/en/pj_manual/lineup.html

1. Check the product overview, supplied items and part names

1-1. Introduction to the Projector

This section introduces you to your new projector and describes the features and controls.

- **Liquid crystal type high brightness/high resolution projector**

This projector has a display resolution of 1920 dots × 1200 lines (WUXGA) and an aspect ratio of 16:10.

Model	Brightness
PV800UL-W/PV800UL-B	8000 lm
PV710UL-W/PV710UL-B	7100 lm

- **A long-life laser diode is equipped in the light module**

The product can be operated at low cost because the laser light source can be used for a long time without requiring replacement or maintenance.

- **Wide range of optional lenses selectable according to the place of installation**

This projector supports 10 types of optional lenses, providing a selection of lenses adapted to a variety of places of installation and projection methods.

Note that no lens is mounted upon shipment from the factory. Please purchase optional lenses separately.

- **Motorized lens control function for easily adjusting the position of the projected image**

The position of the projected image (lens shift) can be adjusted by buttons either on the control panel on the back of the cabinet or the remote control.

- **360 degree free projection**

This projector can be installed universally in every angle.

For controlling fine inclination, use the tilt foot. Install an appropriate metal and a stand that has enough strength to support the projector for controlling the installation angle.

- **Seamless switch function for smoother screen changes when switching the signal**

When the input connector is switched, the image displayed before switching is held so that that the new image can be switched to without a break due to absence of a signal.

- **Supports wired LAN**

Equips the LAN and Ethernet/HDBaseT (RJ-45) ports. Utilizing a wired LAN connected with these ports, it enables to control the projector by a computer.

1. Check the product overview, supplied items and part names

- **Convenient software applications**

Compatible with our software applications (NaViSet Administrator 2, ProAssist, Virtual Remote Tool, etc.). The projector can be controlled from a computer connected via a wired LAN.

- NaViSet Administrator 2

You can monitor the status of the projector and control a variety of functions.

- ProAssist

You can control the projector and correct any distortions when projecting onto uniquely shaped screens, like circular, spherical, or other such surfaces.

- Virtual Remote Tool

A virtual remote control is displayed on the computer screen to perform simple controls such as turning the projector on/off, switching signals, etc. It is also possible to change the background logo of the projector.

Please visit our web site for downloading each software.

URL: <https://www.sharp-nec-displays.com/dl/en/index.html>

- **CRESTRON ROOMVIEW and Extron XTP compatibility**

The projector supports CRESTRON ROOMVIEW and Extron XTP, allowing multiple devices connected in the network to be managed and controlled from a computer. Moreover, it enables to output and control image via an Extron XTP transmitter connected with the projector.

- **0.16 W (100-130 V AC)/0.32 W (200-240 V AC) in standby condition with energy saving technology**

Selecting [NORMAL] for [STANDBY MODE] from the menu can put the projector in power-saving mode.

NORMAL: 0.16 W (100-130 V AC)/0.32 W (200-240 V AC)

NETWORK STANDBY: 1.6 W (100-130 V AC)/1.8 W (200-240 V AC)

- **[LIGHT MODE] and “Carbon Meter” display**

Three [LIGHT MODE] options can be selected according to the purpose of use. [LIGHT ADJUST] can also be used to reduce output power and control energy consumption. The energy-saving effect from that time will be factored into the amount of reduced CO₂ emissions and displayed in the confirmation message when turning the power off as well as the [INFO.] area in the on-screen menu (CARBON METER)

1. Check the product overview, supplied items and part names

1-2. What's in the Box?

Make sure your box contains everything listed. If any pieces are missing, contact your dealer. Please save the original box and packing materials if you ever need to ship your projector.

Projector

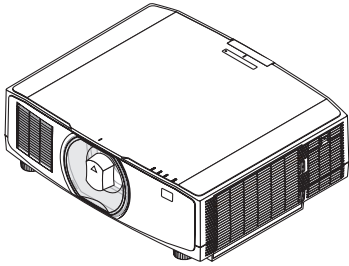

Dust cap for lens
(24F53241)

* The projector is shipped without a lens.

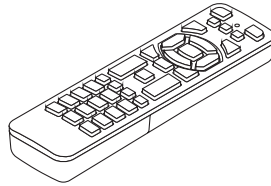

Remote control
(7N901322)

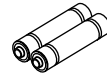

AAA alkaline batteries (x2)

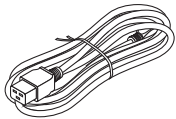

Power cord

Plug type	
For USA	For EU
7N080242	7N080028

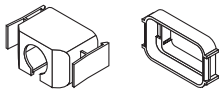

Power cord stopper
(24F53221/24F53232)



Strap
(24F54153)



Lens theft prevention screw
(24V00941)

Documents

- Important Information (TINS-0003VW02/TINS-0004VW02/TINS-0023VW01)
Depending on the region of purchase, one or two of these may be included.
- Quick Setup Guide (TINS-0005VW01)
- Security Sticker (Use this sticker when security password is set on.)

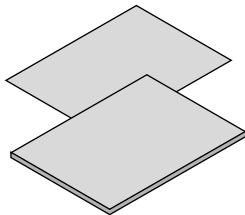

For North America only

Limited warranty

For customers in Europe

You will find our current valid Guarantee Policy on our Web Site:

<https://www.sharpecdisplays.eu>

1-3. Part Names of the Projector

Front

The lens is sold separately. The description below is for when the NP13ZL lens is mounted.

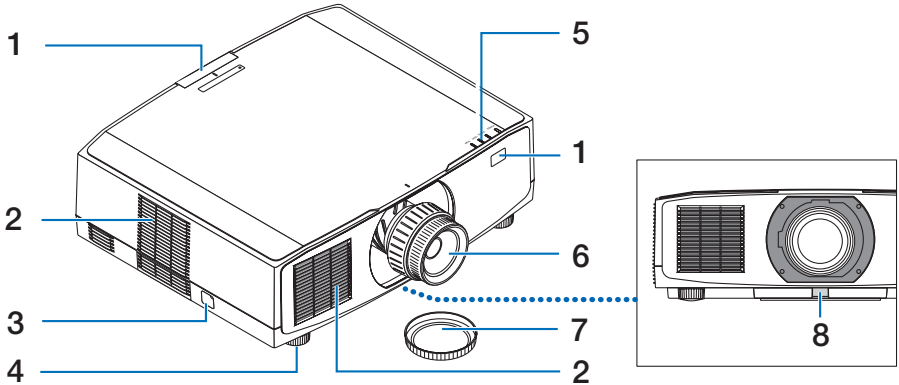

1. Remote Sensor

This part receives signals from the remote control. There are two locations on the front and back of the projector.

2. Intake vent

Takes in outside air to cool the unit.

3. Security Bar

Attach an anti-theft device. The security bar accepts security wires or chains up to 0.18 inch/4.6 mm in diameter.

4. Adjustable Tilt Foot

Rotate the tilt feet to adjust the left/right orientation.

5. Indicator Section

The indicator light turns on or blinks to relay the status of the projector (Power ON/ Standby/etc.)

6. Lens

Images are projected from here. (Lens unit sold separately.)

7. Lens Cap

(The optional lens is shipped with the lens cap.)

8. Lens Release Button

Use this to remove the lens unit.

1. Check the product overview, supplied items and part names

Rear

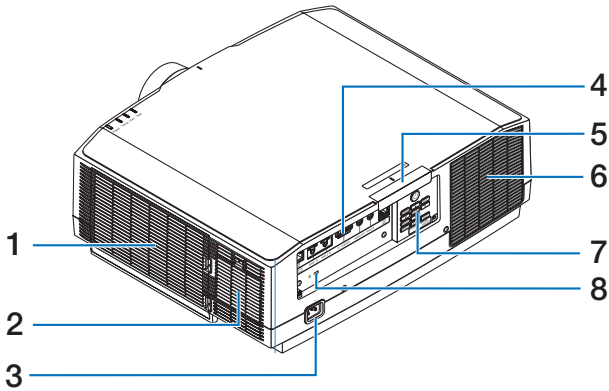

1. Intake vent/Filter

Takes in outside air to cool the unit. The filter prevents dust and dirt from entering inside.

2. Intake vent

Takes in outside air to cool the unit.

3. AC IN Terminal

Connect the supplied power cord's three-pin plug here, and plug the other end into an active wall outlet.

4. Terminals

Connect the cables for the various audio and video signals.

5. Remote Sensor

This part receives signals from the remote control. There are two locations on the front and back of the projector.

6. Exhaust vent

Heated air is exhausted from here.

7. Controls

The projector's power can be turned ON/OFF, and the signal for the projected image can be switched here.

8. Security Slot (🔒)*

This is used when attaching an anti-theft cable.

* Security and theft protection lock compatible with Kensington security cables/equipment. For products, visit Kensington's website.

Controls/Indicators

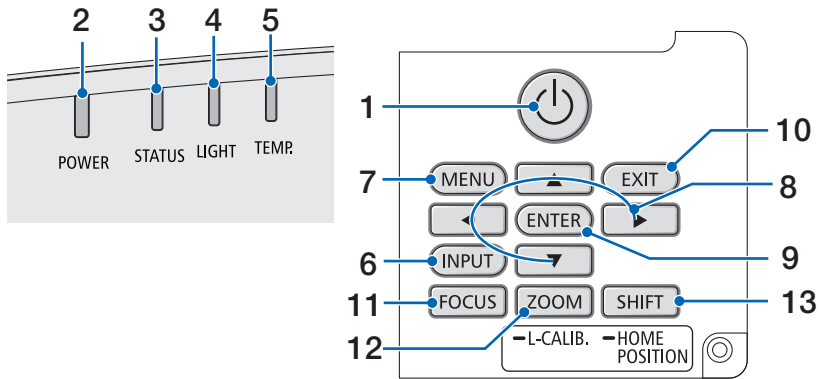

1. (POWER) Button

Switches between projector's power on and standby.

When turning off the power (standby), pressing the button once will bring up a confirmation message on the screen, so press the button one more time.

2. POWER Indicator

Indicates the projector's power state. The indicator lights up in blue when the power is on. Depending on the state of power, it will light up or blink in either green or orange when power is off. Refer to the "Indicator Message" section for details. (→ page 40)

3. STATUS Indicator

This lights up or blinks when an operation button is pressed while the unit is in key lock mode, while the lens is calibrating, etc. Refer to the "Indicator Message" section for details. (→ page 40)

4. LIGHT Indicator

Indicates the state of the light source.

5. TEMP. Indicator

Indicates high temperatures around the projector.



6. INPUT Button

Selects the input signal. Pressing it quickly will display the input selection screen. Pressing it for one second or longer will begin a series of automatic checks in the order of HDMI1 → HDMI2 → HDBaseT, and if an input signal is detected then that signal will be projected.

7. MENU Button

Displays the on-screen menu for various settings and adjustments.

8. / Volume Buttons

- When the on-screen menu is displayed, use the  buttons to select the item that you wish to set or adjust.
- Changes the pattern when the test pattern is displayed.
- When the on-screen menu is not displayed, use the  buttons to adjust the sound output from the projector.

9. ENTER Button

Moves to the next menu when the on-screen menu is displayed. Confirms the item when the confirmation message is displayed.

10. EXIT Button

Returns to the menu on the previous level when the on-screen menu is displayed. Closes the menu when a cursor appears in the main menu. Cancels the operation when the confirmation message is displayed.

11. FOCUS Button

Applicable lens unit: NP40ZL/NP41ZL/NP43ZL/NP44ML/NP50ZL

Open the focus adjustment screen and focus the projected image.

12. ZOOM/L-CALIB. Button

Applicable lens unit: NP40ZL/NP41ZL/NP43ZL/NP44ML/NP50ZL

- Short press to open the zoom adjustment screen. Finely adjust the size of the projected image.
- Long press (two seconds or longer) to correct the adjustment range of the attached lens unit (calibration).

13. SHIFT/HOME POSITION Button

- Short press to display the lens shift screen. Adjust them using the ▼▲◀▶ buttons.
- Long press (2 seconds or longer) to return the lens shift adjustment to its initial position.

1. Check the product overview, supplied items and part names

Terminal Panel Features

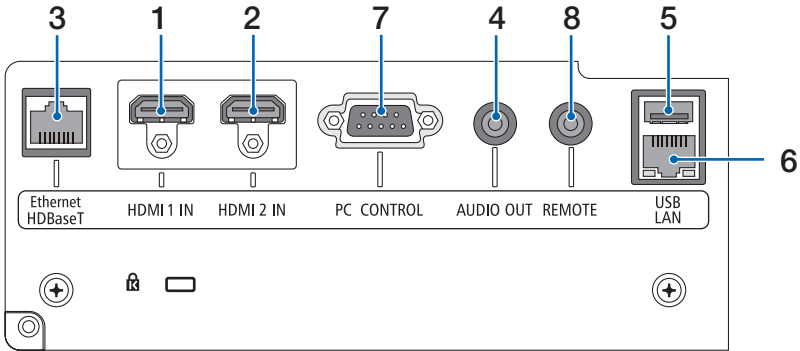

1. HDMI 1 IN Terminal (Type A)

Connects to the output terminals of a computer, blu-ray player, etc.

2. HDMI 2 IN Terminal (Type A)

Connects to the output terminals of a computer, blu-ray player, etc.

3. Ethernet/HDBaseT Port (RJ-45)

Connects to a commercially available HD-BaseT compatible transmission devices.

4. AUDIO OUT Mini Jack (Stereo Mini)

Outputs the audio signal corresponding to the image projected from the projector.

5. USB Port (Type A)

Use a 5 V / 1.4 A power supply.

6. LAN Port (RJ-45)

Connects the unit to a wired LAN.

7. PC CONTROL Port (D-Sub 9 Pin)

Use this port to connect a PC or control system. This enables you to control the projector using serial communication protocol.

8. REMOTE Terminal (Stereo Mini)

Use this terminal for wired remote control of the projector.

NOTE:

- When a remote control cable is connected to the REMOTE terminal, infrared remote control operations cannot be performed.
- When [HDBaseT] is selected in the [REMOTE SENSOR] and the projector is connected to a commercially-available transmission device that supports HDBaseT, remote control operations in infra-red cannot be carried out if transmission of remote control signals has been set up in the transmission device. However, remote control using infrared rays can be carried out when the power supply of the transmission device is switched off.

1. Check the product overview, supplied items and part names

1-4. Part Names of the Remote Control

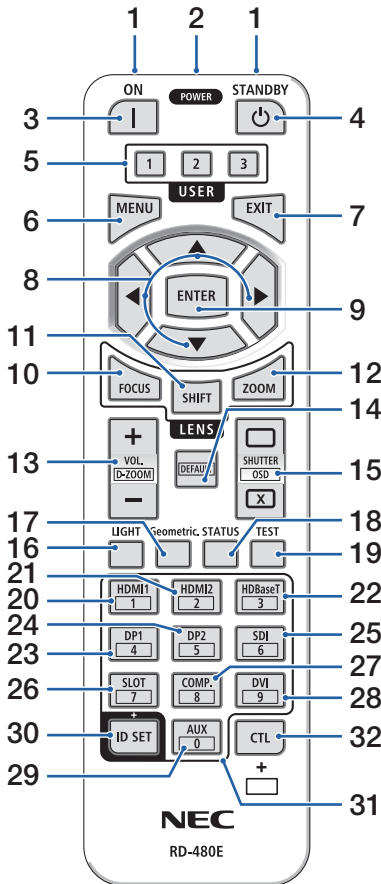

1. Infrared Transmitter

Remote control signals are sent via infrared signal. Point the remote control at the remote control receiver on the projector.

2. Remote Jack

Connect a commercially available remote cable here for wired operation.

3. POWER ON Button (|)

Turns power ON when in sleep or standby mode.

4. POWER STANDBY Button (⏻)

Pressing the button once will display the shutdown confirmation message. Press the POWER STANDBY (or ENTER) button once more to power down the projector.

5. USER 1/2/3 Button

The following functions are set at the time of shipment.

USER 1: (No function)

USER 2: AV-MUTE

Turns off the image and sound for a short period of time. Press the button again to unmute.

USER 3: FREEZE

Changes the projected video to a still image.

Press the button again to resume.

Functions can also be set by selecting them from the 9 function types.

6. MENU Button

Displays the on-screen menu for various settings and adjustments.

7. EXIT Button

Returns to the menu on the previous level when the on-screen menu is displayed. Closes the menu when a cursor appears in the main menu. Cancels the operation when the confirmation message is displayed.

1. Check the product overview, supplied items and part names

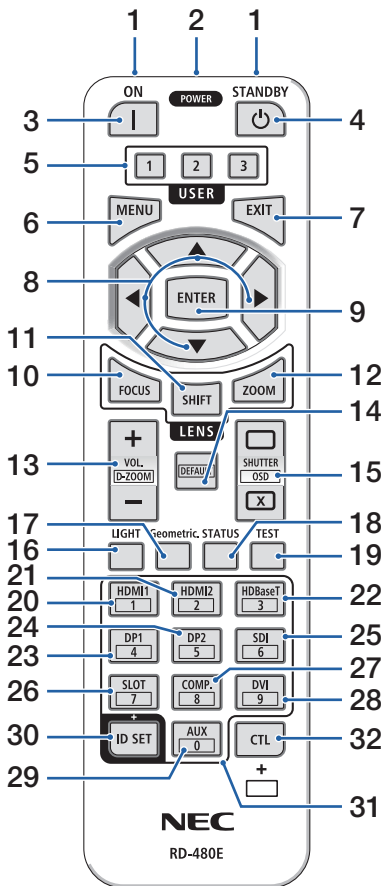

8. ▲▼◀▶ Button

- When the on-screen menu is displayed, use the ▼▲◀▶ buttons to select the item that you wish to set or adjust.
- Changes the pattern when the test pattern is displayed.

9. ENTER Button

Moves to the next menu when the on-screen menu is displayed. Confirms the item when the confirmation message is displayed.

10. FOCUS Button

Applicable lens unit: NP40ZL/NP41ZL/NP43ZL/ NP44ML/NP50ZL

Opens the focus adjustment screen. Adjust the focus (of the lens) with the ◀ / ▶ buttons.

11. SHIFT Button

The lens shift adjustment screen will be displayed. Use the ▼▲◀▶ buttons to adjust the lens position.

12. ZOOM Button

Applicable lens unit: NP40ZL/NP41ZL/NP43ZL/ NP44ML/NP50ZL

Opens the zoom adjustment screen. Adjust zoom with the ◀ / ▶ buttons.

13. VOL./D-ZOOM (+)(-) Button

Adjusts the volume level of the audio output terminals. Simultaneously pressing the CTL button will expand or shrink the image (return to the original state).

14. DEFAULT Button

(Not available on this series of projectors. For future expansion)

1. Check the product overview, supplied items and part names

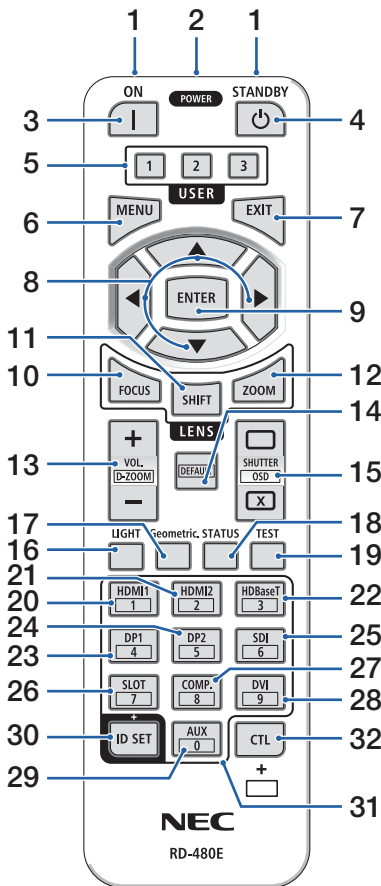

15. SHUTTER/OSD OPEN (□)/CLOSE (X) Button

Press the CLOSE button to turn off the light source and temporarily stop projection. Press the OPEN button to resume. Simultaneously press the CTL and CLOSE buttons to close the on-screen display (On-Screen Mute). Simultaneously press the CTL and OPEN buttons to go back.

16. LIGHT Button

Displays the light mode screen.

17. Geometric. Button

Displays [GEOMETRIC CORRECTION] from the on-screen menu. Use it to adjust distortions in projected images.

18. STATUS Button

Displays [USAGE TIME] of [INFO.] from the on-screen menu.

19. TEST Button

Projects a test pattern.

20. HDMI1 Button

Selects the HDMI1 input.

21. HDMI2 Button

Selects the HDMI2 input.

22. HDBaseT Button

Selects HDBaseT.

23. DP1 Button

(Not available on this series of projectors.)

24. DP2 Button

(Not available on this series of projectors.)

25. SDI Button

(Not available on this series of projectors.)

26. SLOT Button

(Not available on this series of projectors.)

27. COMP. Button

(Not available on this series of projectors.)

1. Check the product overview, supplied items and part names

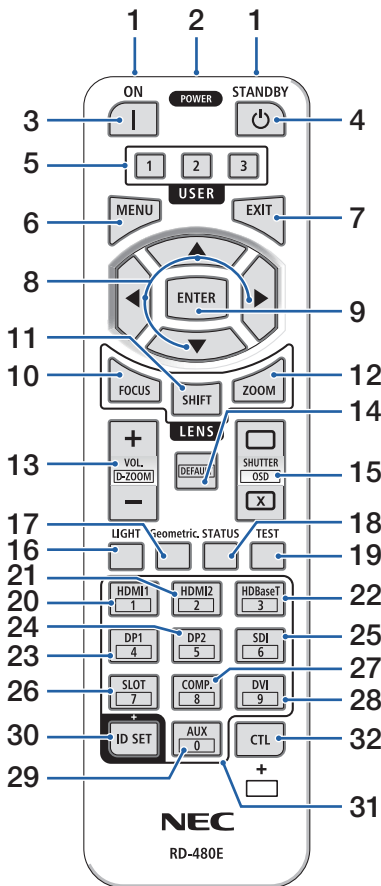

28. DVI Button

(Not available on this series of projectors.)

29. AUX Button

(Not available on this series of projectors. For future expansion)

30. ID SET Button

Used to set the control ID when performing individual operations on multiple projectors using the remote control.

31. Numeric Keypad Button

Used to input the control ID when performing individual operations on multiple projectors using the remote control (set the control ID). Pressing the 0 button while holding down the ID SET button will remove any control ID settings.

32. CTL Button

This is a multipurpose button for combined use with other buttons.

Battery Installation

1. Press the catch and remove the battery cover.

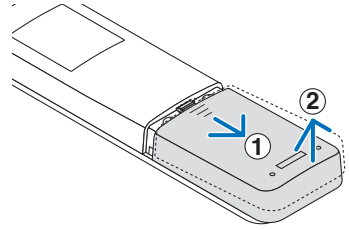

2. Install new ones (AAA). Ensure that you have the batteries' polarity (+/-) aligned correctly.

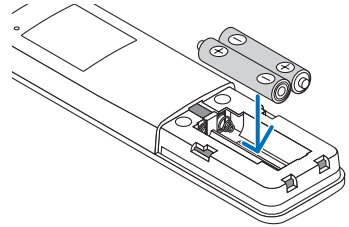

3. Slip the cover back over the batteries until it snaps into place.

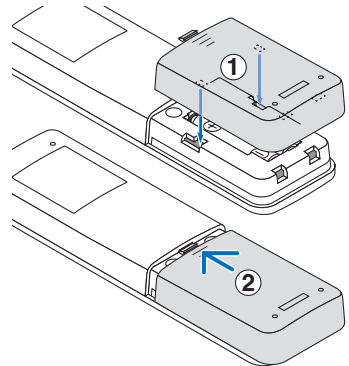

NOTE:

- Do not mix different types of batteries or new and old batteries.
-

Remote Control Precautions

- Handle the remote control carefully.
- If the remote control gets wet, wipe it dry immediately.
- Avoid excessive heat and humidity.
- Do not short, heat, or take apart batteries.
- Do not throw batteries into fire.
- If you will not be using the remote control for a long time, remove the batteries.
- Ensure that you have the batteries' polarity (+/-) aligned correctly.
- Do not use new and old batteries together, or use different types of batteries together.
- Dispose of used batteries according to your local regulations.
- Please note that if multiple projectors are installed nearby, other projectors may unintentionally light up when you turn on the power using the remote control.

1. Check the product overview, supplied items and part names

Operating Range for Wireless Remote Control

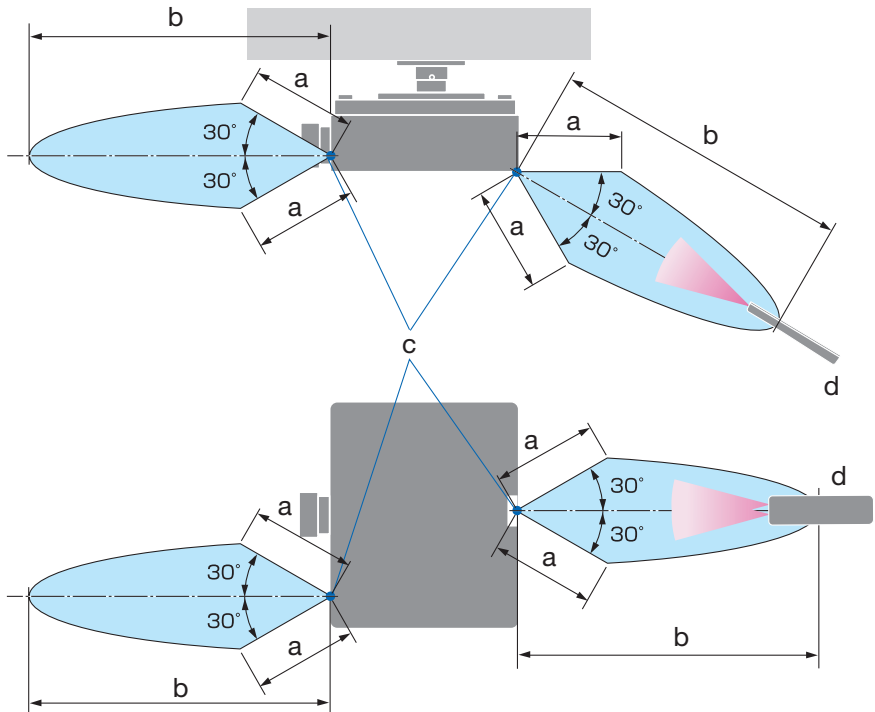

a: 7 m/276" / b: 20 m/787" / c: Remote sensor on projector cabinet / d: Remote control

- The projector will not respond if there are objects between the remote control and the sensor, or if strong light falls on the sensor. Weak batteries will also prevent the remote control from properly operating the projector.

1. Check the product overview, supplied items and part names

Using the Remote Control in Wired Operation

Connect one end of the remote cable to the REMOTE terminal and the other end to the remote jack on the remote control.

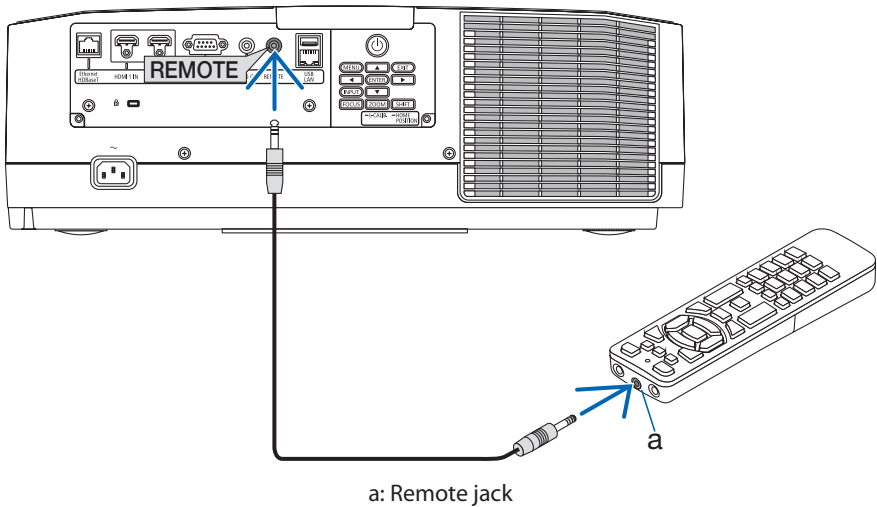

NOTE:

- When a remote cable is inserted into the REMOTE terminal, the remote control does not work for infrared wireless communication.
 - Power will not be supplied to the remote control by the projector via the REMOTE jack. Battery is needed when the remote control is used in wired operation.
-

2. Projecting an Image (Basic Operation)

This section describes how to turn on the projector and to project a picture onto the screen.

2-1. Flow of Projecting an Image

Step 1

- **Connecting your computer / Connecting the power cord** (→ [page 17](#))



Step 2

- **Turning on the projector** (→ [page 19](#))



Step 3

- **Selecting a source** (→ [page 22](#))



Step 4

- **Adjusting the picture size and position** (→ [page 24](#))



Step 5

- **Adjusting a picture and sound** (→ [page 34](#))



Step 6

- **Making a presentation**



Step 7

- **Turning off the projector** (→ [page 35](#))



Step 8

- **After use** (→ [page 36](#))

2-2. Connecting Your Computer/Connecting the Power Cord

1. Connect your computer to the projector.

This section will show you a basic connection to a computer.

Connect a commercially available HDMI cable between the computer's HDMI output connector and the projector's HDMI 1 IN or HDMI 2 IN connector.

2. Connect the supplied power cord to the projector.

First connect the supplied power cord's three-pin plug to the AC IN terminal of the projector, and then connect another plug of the supplied power cord directly in the wall outlet. Do not use any plug converter.



CAUTION:

- This equipment is designed to be used in the condition of the power cord connected to earth. If the power cord is not connected to the earth, it may cause electric shock. Please make sure the power cord is connected to the wall outlet directly and earthed properly. Do not use a 2-pin plug converter adapter.
- Be sure to connect the projector and the computer (signal source) to the same earth point. If the projector and the computer (signal source) will be connected to different earth points, fluctuations in the earth potential may cause fire or smoke.
- To prevent the power cord from coming loose, make sure that all the prongs of the power cord plug are fully inserted into the AC IN terminal of the projector before using the power cord stopper. A loose contact of the power cord may cause a fire or electric shock.

Upon connecting the power cable, the POWER indicator of the projector will light.

2. Projecting an Image (Basic Operation)

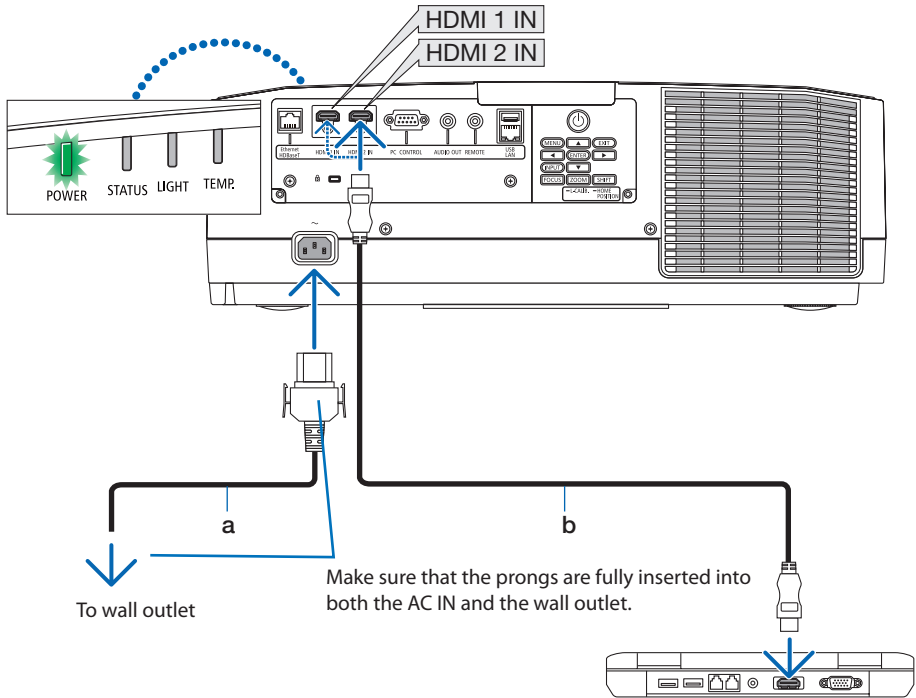

a: Power cord (supplied) / b: HDMI cable (not supplied)

- Use a certified High Speed HDMI® Cable.
- To prevent the power cord from accidentally removing from the AC IN of the projector, use the power cord stopper. Insert the power cord plug to the AC IN terminal until the power cord stopper is fastened completely and click sound is heard.

CAUTION:

Parts of the projector may become temporarily heated if the projector is turned off with the POWER button or if the AC power supply is disconnected during normal projector operation. Use caution when picking up the projector.

NOTE:

- If you pull on the power supply cord while the connector is fixed, the main unit may fall down and be damaged.

2-3. Turning on the Projector

WARNING

The projector produces a strong light. When turning on the power, operate from the side or rear of the projector (outside the hazard zone). Also, when turning on the power, make sure no one within the projection range is looking at the lens.

1. Remove the lens cap.

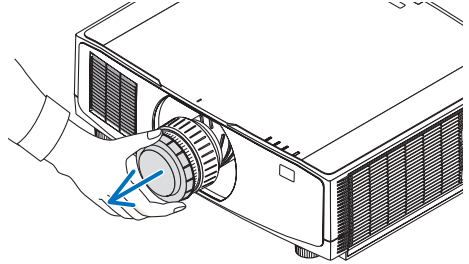

2. Press the (POWER) button on the projector cabinet or the POWER ON button on the remote control.

The POWER indicator lit in green will start to blink in blue. After that, the image will be projected onto the screen.

TIP:

- When the message "PROJECTOR IS LOCKED! ENTER YOUR PASSWORD." is displayed, it means that the [SECURITY] feature is turned on.

After you turn on your projector, ensure that the computer or video source is turned on.

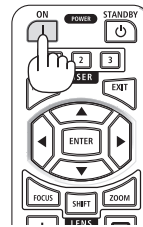

NOTE:

- A blue screen (blue background) is displayed when no signal is being input (by factory default menu settings).

Performing Lens Calibration

After mounting the separately available lens unit or replacing a lens unit, perform [LENS CALIBRATION] by holding to press ZOOM/L-CALIB. button on the cabinet over two seconds.

Calibration corrects the adjustable zoom, shift, and focus range. If calibration is not performed, you may not be able to get the best focus and zoom even if you adjust the focus and zoom for the lens.

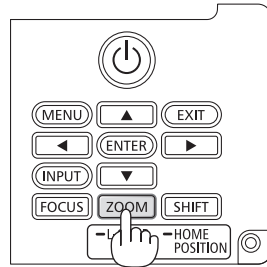

Note on Startup screen (Menu Language Select screen)

When you first turn on the projector, you will get the Startup menu. This menu gives you the opportunity to select one of the 30 menu languages.

To select a menu language, follow these steps:

1. Use the ▲, ▼, ◀ or ▶ button to select one of the 30 languages from the menu.

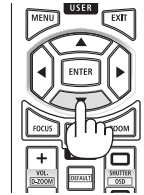

2. Press the ENTER button to execute the selection.

After this has been done, you can proceed to the menu operation.

If you want, you can select the menu language later.

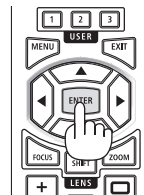

NOTE:

- Keep the lens cap off the lens while the projector's power is on.
If the lens cap is on, it could be warped due to high temperature.
- If the STATUS indicator lights orange with the power button pressed, the projector will not be turned on since the [CONTROL PANEL LOCK] has been [ON]. Cancel the lock by turning it off.
- While the POWER indicator is blinking blue in short cycles, the power cannot be turned off by using the power button.

2-4. Selecting a Source

Selecting the computer or video source

NOTE:

- Turn on the computer or video source equipment connected to the projector.

Detecting the Signal Automatically

Press the INPUT button for 1 second or longer. The projector will search for the available input source and display it. The input source will change as follows:

HDMI1 → HDMI2 → HDBaseT → HDMI1 → ...

- Press it briefly to display the [INPUT] screen.

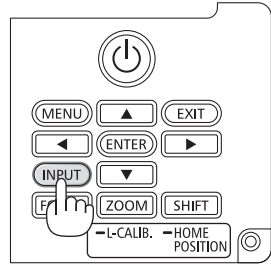

- Press the ▼/▲ buttons to match the target input terminal and then press the ENTER button to switch the input. To delete the menu display in the [INPUT] screen, press the MENU or EXIT button.

TIP:

- If no input signal is present, the input will be skipped.

Using the Remote Control

Press any one of the HDMI1, HDMI2, or HDBaseT button.

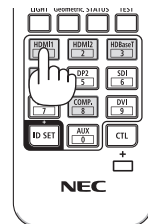

Selecting Default Source

You can set a source as the default source so that it will be displayed each time the projector is turned on.

1. Press the MENU button.

The menu will be displayed.

2. Press the ► button to select [SETUP] and press the ▼ button or the ENTER button to select [GENERAL].

3. Press the ► button to select [OPTIONS(2)] and press the ▼ button or the ENTER button.

4. Press the ▼ button 4 times to select [DEFAULT INPUT SELECT] and press the ENTER button.

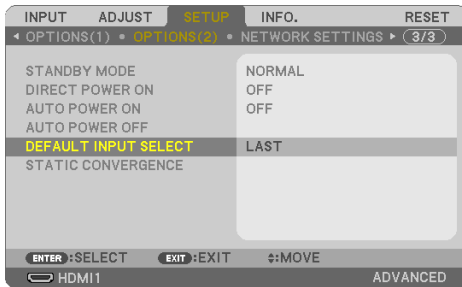

The [DEFAULT INPUT SELECT] screen will be displayed.

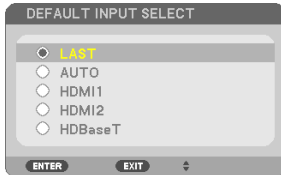

5. Select a source as the default source, and press the ENTER button.

6. Press the EXIT button a few times to close the menu.

7. Restart the projector.

The source you selected in step 5 will be projected.

2-5. Adjusting the Picture Size and Position

Use the lens shift, the adjustable tilt foot, the zoom and the focus to adjust the picture size and position.

In this chapter drawings and cables are omitted for clarity.

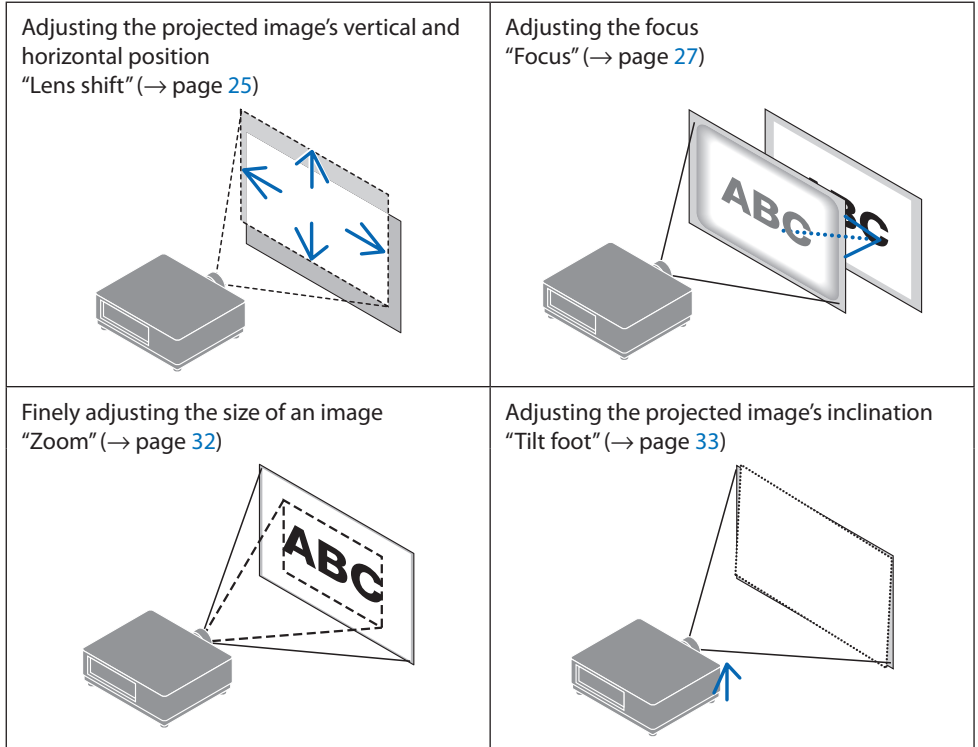

NOTE:

- When adjusting lens shift, motorized focus, or motorized zoom using either the remote control or the buttons on the projector cabinet, do not use TEST PATTERN and use one of the following.
 - Display the pattern used for adjusting focus on the background.
 - Project an image (your adjustment pattern) from a computer, etc., connected to the projector.

Displaying the pattern used for adjusting focus as background

1. Display the on-screen menu, select [SETUP]→[MENU]→[BACKGROUND], and set to [FOCUS].
2. Switch to a terminal without an input signal to set the device to no-signal state.

Once you are finished adjusting the projected image, set [BACKGROUND] to a setting other than [FOCUS] as needed.

Adjusting the vertical position of a projected image (Lens shift)

CAUTION

- Perform the adjustment from behind or from the side of the projector. If adjustments are performed from the front, your eyes could be exposed to strong light and get injured.
- Keep hands away from the lens mounting portion while performing a lens shift. Failure to do so could result in fingers being pinched by the moving lens.

1. Press either **SHIFT/HOME POSITION** button on the cabinet or **SHIFT** button on the remote control.

The [LENS SHIFT] screen will be displayed.

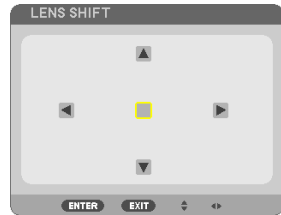

2. Press the **▼▲◀▶** buttons to move the projected image.

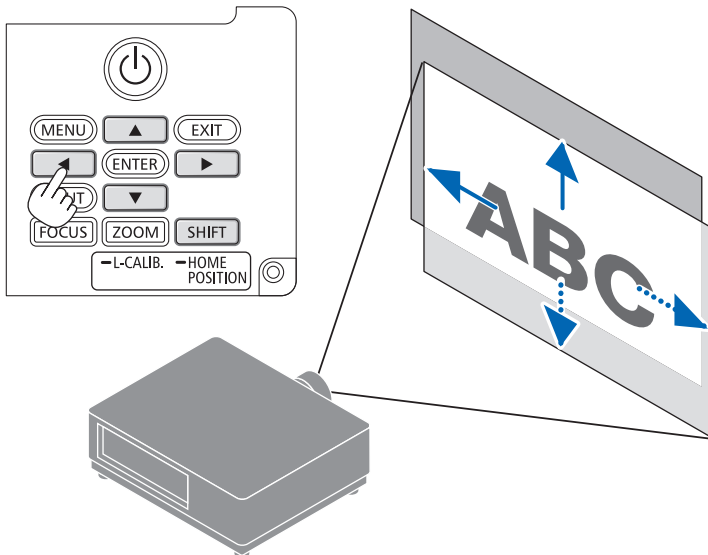

To set back the lens to the home position

Press and hold the **SHIFT/HOME POSITION** button over 2 seconds. The lens mounted on the projector goes back to the home position. (roughly to the center position)

2. Projecting an Image (Basic Operation)

NOTE:

- If the lens is shifted to the maximum in the diagonal direction, the screen peripheral area will be dark or shaded.
- Use NP11FL at the home position. If necessary, fine-adjust the position of the projected image using the lens shift function.
- Fix the NP50ZL to the projector using the supplied support kit. Loosen the bolts of the support kit, you can adjust the lens shift.
- Fix the NP44ML to the projector using the separately sold support kit (NP01LK). Lens shift is not available for the NP44ML.

TIP:

- The figure below shows the lens shift adjustment range (projection method: Desktop/Front) of the NP41ZL lens unit.

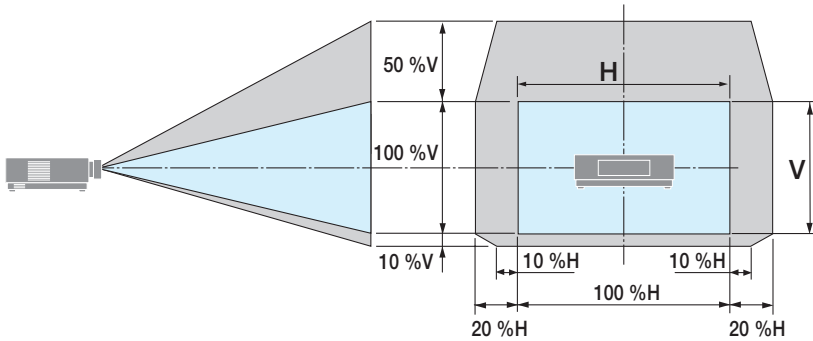

Description of symbols: V indicates vertical (height of the projected image), H indicates horizontal (width of the projected image).

Focus

We recommend adjusting focus after the pattern used for adjusting focus on background has been displayed for 30 minutes. (→ page 24)

Applicable lens: NP12ZL/NP13ZL/NP14ZL/NP15ZL (Manual focus)

Use the focus ring to obtain the best focus.

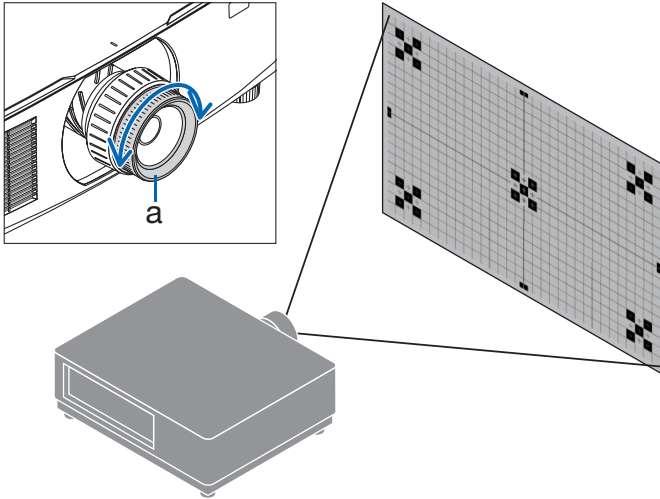

a: Focus ring

Applicable lens: NP11FL (Manual focus)

With the NP11FL lens, adjust the focus and picture distortion.

Preparations:

Press and hold the SHIFT/HOME POSITION button on the cabinet longer than 2 seconds for shifting back the lens to the home position.

1. Turn the distortion ring to the left edge.

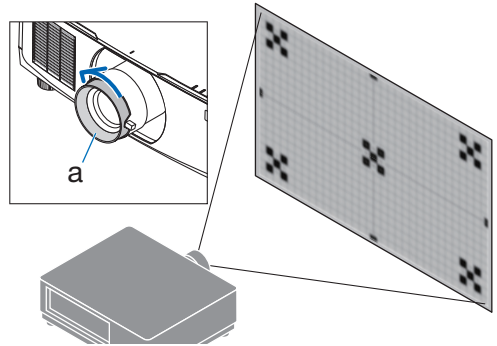

a: Distortion ring

2. Turn the focus lever clockwise and counterclockwise to adjust the focus at the center of the screen.

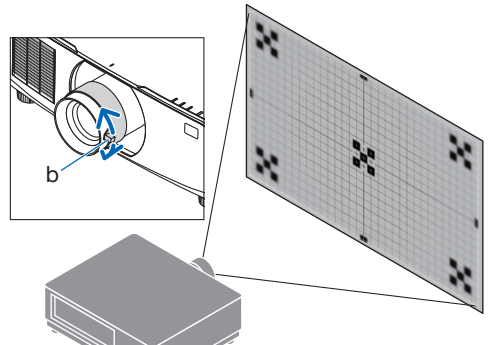

b: Focus lever

3. Use the distortion ring to correct the screen's distortion.

(This also brings the screen peripheral area into focus.)

4. Use the focus lever to adjust the screen's overall focus.

* If the focus at the center of the screen is off, turn the distortion ring a little counterclockwise. The focus at the center of the screen can now be adjusted with the focus lever.

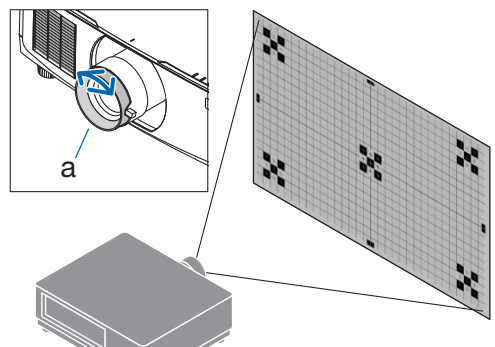

a: Distortion ring

Applicable lens: NP40ZL/NP41ZL (Motorized focus)

1. Press the FOCUS button.

The [LENS FOCUS] control screen will be displayed on.



Press ◀▶ buttons to adjust focus.

2. When the cursor is on the [CENTER] on on-screen menu, press either ◀ or ▶ button to align focus around the optical axis.

* The picture shows an example when the lens shift is moved upward. The focus for the lower part of the screen is aligned.

When the lens is at the center, the focus for the center of the screen is aligned.

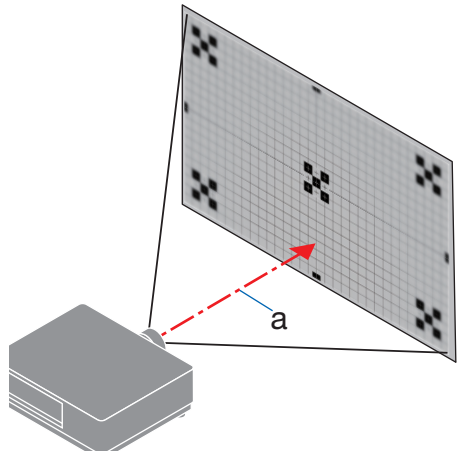
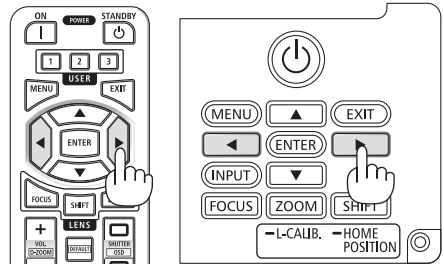
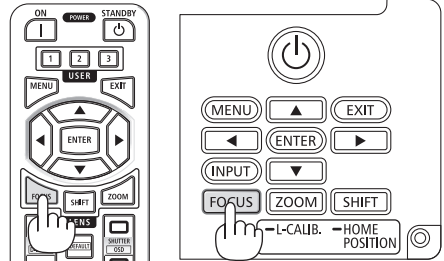

a: Optical axis

2. Projecting an Image (Basic Operation)

3. Press **▼** button to select the [PERIPHERY] on the on-screen menu, and then press either **◀** or **▶** button to align the focus of screen peripheral area. During this operation, the focus for around the optical axis will be maintained.

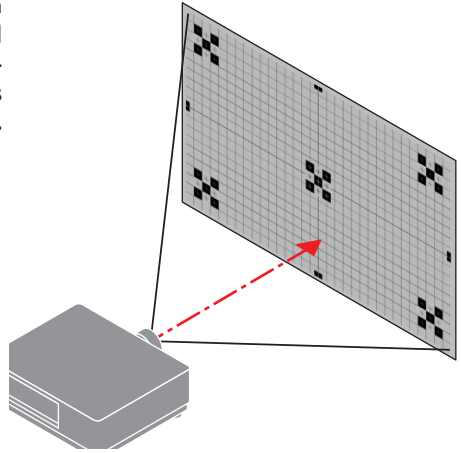

Applicable lens: NP43ZL/NP50ZL (Motorized focus)

1. Press the FOCUS button.

The [LENS FOCUS] control screen will be displayed on.



Press **◀▶** buttons to adjust focus.

* [PERIPHERY] LENS FOCUS is not available for this lens unit.

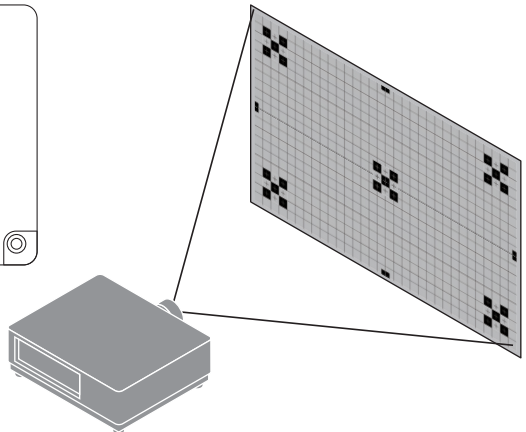
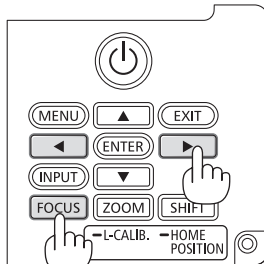
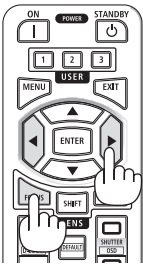

Applicable lens: NP44ML (Motorized focus)

- The NP44ML must be fixed to the projector using the separately sold support kit (NP01LK). The support kit is not shown on this illustration.

1. Press the FOCUS button.

The [LENS FOCUS] control screen will be displayed on.



Press ◀▶ buttons to adjust focus of screen center.

- * Does not work for [PERIPHERY] on the [LENS FOCUS] screen. Use the [LENS ZOOM] control screen to adjust the focus of the peripheral area.

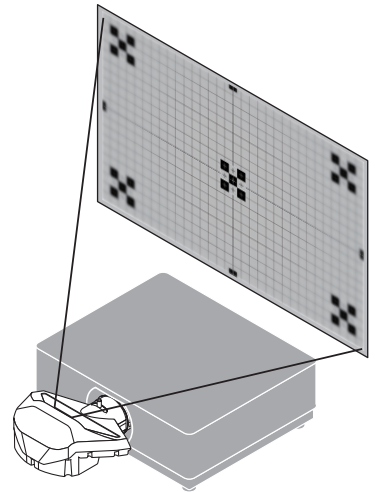
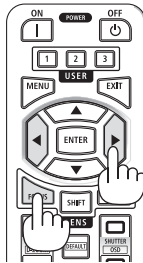

2. Press the ZOOM/L-CALIB. button on the cabinet.

The [LENS ZOOM] control screen will be displayed on.

- * In another way, press the ZOOM button on the remote control.



Press ◀▶ buttons to align the focus of screen peripheral area.

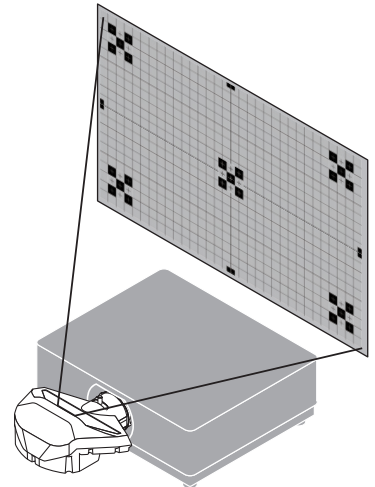
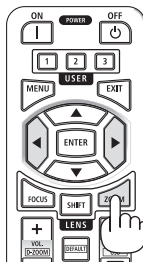

Zoom

Applicable lens: NP12ZL/NP13ZL/NP14ZL/NP15ZL (Manual zoom)

Turn the zoom ring clockwise and counterclockwise.

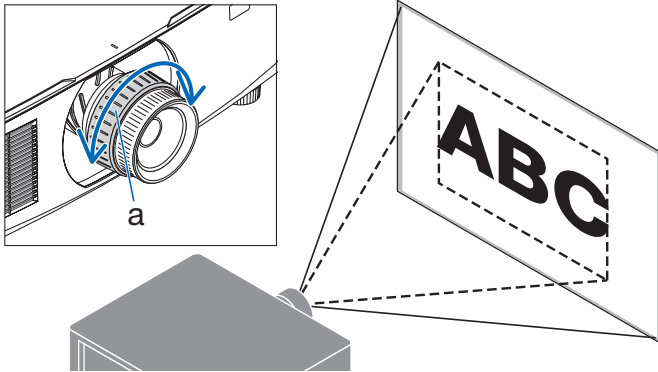

a: Zoom ring

Applicable lens: NP40ZL/NP41ZL/NP43ZL/NP50ZL (Motorized zoom)

1. Press ZOOM/L-CALIB. button.

The [ZOOM] adjustment screen will be displayed on.



- * In another way, press the ZOOM button on the remote control.
Press ◀▶ buttons to adjust zoom.

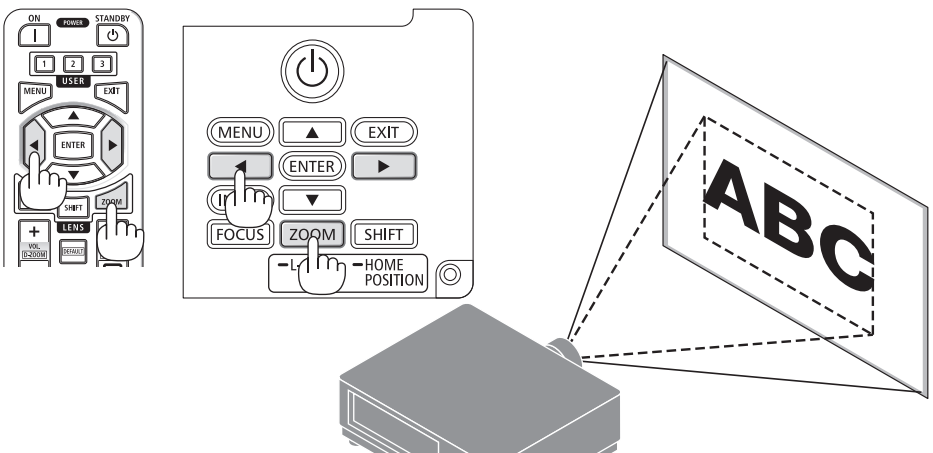

Adjusting the Tilt Foot

1. Turn the left and right tilt foot to adjust.

The tilt foot lengthen and shorten when turned. Turn one of the tilt foot to adjust the image so that it is level.

- The tilt foot can be lengthened by a maximum of 20 mm/0.8".
- The tilt foot can be used to tilt the projector by a maximum of 4°.

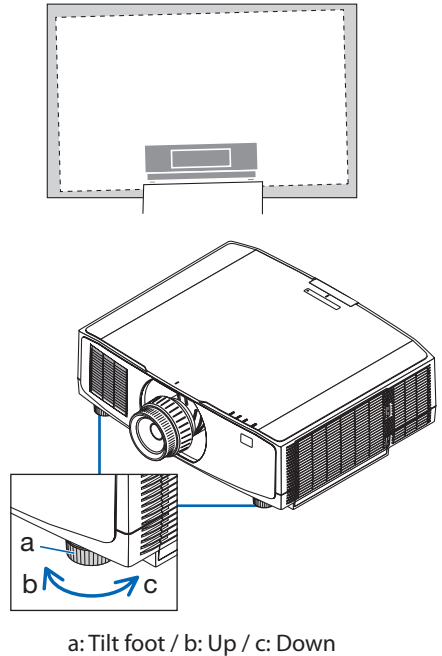

NOTE:

- Do not lengthen the tilt foot any more than 20 mm/0.8". Doing so will make the projector unstable.
- Do not use the tilt foot for any purpose other than adjusting inclination of the projector installation angle. Handling the tilt foot improperly, such as carrying the projector by grasping the tilt foot or hooking it onto a wall using the tilt foot, could damage the projector.

2-6. Adjusting a picture and sound

Adjusting the picture

Display [ADJUST] in the on-screen menu and adjust the picture. Refer to the Installation Manual for details.

Turning Up or Down Volume

Sound level from the AUDIO OUT terminal can be adjusted.

Important:

- Do not turn up the volume to the maximum level on the external speaker system connected to the AUDIO OUT of the projector. Doing so may produce an unexpected, loud sound at the time of turning on or off the projector, causing damage to your hearing. When adjusting the volume on the external speaker system, set volume level of the speaker system to less than half its rating and adjust the volume on the projector to get appropriate sound level.

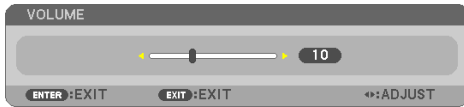

When no menus appear, the ◀ and ▶ buttons on the projector cabinet work as a volume control.

- On the remote control, press the VOL./D-ZOOM (+) or (–) button.
 - +: Increase volume
 - : Decrease volume

NOTE:

- The volume cannot be adjusted using the ◀ or ▶ button in the following cases.
 - When the on-screen menu is displayed
 - When the screen is enlarged by pressing the VOL./D-ZOOM (+) (–) buttons while holding down the CTL button on the remote control

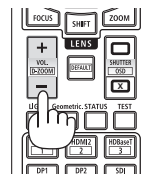
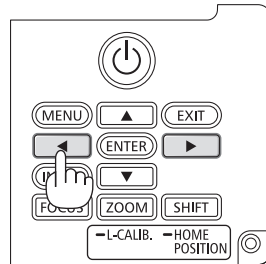



2-7. Turning off the Projector

To turn off the projector:

1. First, press the  (POWER) button on the projector cabinet or the POWER STANDBY button on the remote control.

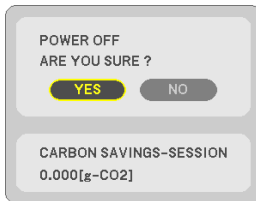
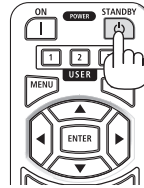
The [POWER OFF / ARE YOU SURE ? / CARBON SAVINGS-SESSION 0.000[g-CO2]] message will appear.



2. Secondly, press the ENTER button or press the  (POWER) or the POWER STANDBY button again.

The light source will be turned off and the power supply will be cut.

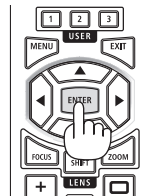

CAUTION

- Parts of the projector may become temporarily heated if the projector is turned off with the POWER button or if the AC power supply is disconnected during normal projector operation. Use caution when picking up the projector.

NOTE:

- While the POWER indicator is blinking blue in short cycles, the power cannot be turned off.
- If the operation to turn off the power is performed while the lens is moving, the power will not turn off until movement of the lens is completed.
- Do not unplug the power cord from the projector or from the power outlet while an image is being projected. Doing so could deteriorate the projector's AC IN terminal or the power plug's contact. To turn off the AC power while an image is being projected, use the breaker, etc.
- Do not disconnect the AC power supply to the projector within 10 seconds of making adjustment or setting changes and closing the menu. Doing so can cause loss of adjustments and settings.

2-8. After Use

1. Unplug the power cord.

For pulling out the power plug, press and hold the protruded section on the left and right sides of the power cord stopper.

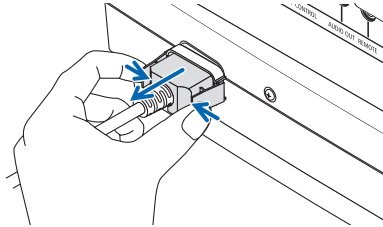

2. Disconnect any other cables.

3. Mount the lens cap on the lens.

4. Before moving the projector, screw in the tilt foot if they have been lengthened.

3. Appendix

3-1. Specifications

Model name		PV800UL-W/PV800UL-B	PV710UL-W/PV710UL-B
Method		Three primary color liquid crystal shutter projection method	
Specifications of main parts			
Liquid crystal panel	Size	0.76" × 3 (aspect ratio: 16:10)	
	Pixels ^{(*)1}	2,304,000 (1920 dots × 1200 lines)	
Projection lenses	Refer to the specifications of option lens (→ 39 page)		
	Zoom	Manual/Motorized	
	Focus	Manual/Motorized	
	Lens shifting	Motorized	
Light source		Laser diode with Phosphor	
Optical device		Optical isolation by dichroic mirror, combining by dichroic prism	
Light output ^{(*)2} ^{(*)3}		8000 lm	7100 lm
Screen size (throw distance)		30" - 500" (Throw distance depends on the lens)	
Color reproducibility		10-bit color processing (approx. 1.07 billion colors)	
Scanning frequency	Horizontal	15 kHz, 24 to 100 kHz	
	Vertical	24, 25, 30, 48 Hz, 50 to 85 Hz	
Input/output connectors			
HDMI	Video input	Type A × 2 LipSync, HDCP ^{(*)4} , 4K	
	Audio input	Sampling frequency: 32/44.1/48 kHz Sampling bit: 16/20/24 bit	
Ethernet/HDBaseT	Video input	RJ-45 × 1, 100BASE-TX, PLink class2, LipSync, HDCP ^{(*)4} , 4K	
	Audio input	Sampling frequency: 32/44.1/48 kHz Sampling bit: 16/20/24 bit	
Audio output		Stereo mini jack × 1 (Common to all signals)	
USB port		USB type A × 1	
LAN port		RJ-45 × 1, 10BASE-T/100BASE-TX, PLink class2	
Control Terminals			
PC control		D-Sub 9-pin × 1, RS232C	
Remote		Stereo mini jack × 1	
Built-in Speaker		Not applicable	
Usage environment ^{(*)5}		Operating temperature: 32 to 113°F (0 to 45°C) Operating humidity: 20 to 80% (with no condensation) Storage temperature: 14 to 122°F (-10 to 50°C) Storage humidity: 20 to 80% (with no condensation) Operating altitude: 0 to 2600 m/8500 feet (1600 to 2600 m/5500 to 8500 feet: Set [FAN MODE] to [HIGH ALTITUDE])	
Power supply		100-240 V AC, 50/60 Hz	
Power consumption		490 W (100-130 V AC) 467 W (200-240 V AC)	456 W (100-130 V AC) 434 W (200-240 V AC)

Model name		PV800UL-W/PV800UL-B	PV710UL-W/PV710UL-B
Power consumption (Standby state)			
STANDBY MODE	NORMAL	0.16 W (100-130 V AC) / 0.32 W (200-240 V AC)	
	NETWORK STANDBY	1.6 W (100-130 V AC) / 1.8 W (200-240 V AC)	
Rated input current		6.1 A (100-130 V AC) 2.5 A (200-240 V AC)	5.3 A (100-130 V AC) 2.2 A (200-240 V AC)
Power cord specification		15 A or higher	
External dimensions		19.6" (width) × 6.5" (height) × 16.0" (depth)/ 499 (width) × 164 (height) × 407 (depth) mm (not including protruding parts)	
		19.8" (width) × 6.6" (height) × 16.0" (depth)/ 503 (width) × 168 (height) × 407 (depth) mm (including protruding parts)	
Weight		24.7 lbs/11.2 kg (not including lens)	

*1 Effective pixels are more than 99.99%.

*2 Compliance with ISO21118-2020

*3 This is the brightness when lens unit NP41ZL (sold separately) is attached and [LIGHT MODE] is set to [NORMAL], [LIGHT ADJUST] is set to [100], and [PRESET] is set to [HIGH-BRIGHT]. Using [LIGHT ADJUST] will reduce brightness.

*4 If you are unable to view material via the HDMI input, this does not necessarily mean the projector is not functioning properly. With the implementation of HDCP, there may be cases in which certain content is protected with HDCP and might not be displayed due to the decision/intention of the HDCP community (Digital Content Protection, LLC).

Video: HDR, Deep Color, 8/10/12-bit, Lip Sync.

Audio: LPCM; up to 2 ch, sample rate 32/44.1/48 KHz, sample bit; 16/20/24-bit

HDMI: Supports HDCP 1.4

HDBaseT: Supports HDCP 1.4

*5 The projector's protection functions will activate depending on the temperature of the operating environment.

• For additional information visit:

US: <https://www.sharpnecdisplays.us>

Europe: <https://www.sharpnecdisplays.eu>

Global: <https://www.sharp-nec-displays.com/global/>

For information on our optional accessories, visit our website or see our brochure.

The specifications are subject to change without notice.

Option lens (sold separately)

NP11FL	Throw ratio 0.81 : 1, F2.3, f=13.2 mm
NP12ZL	Throw ratio 1.16–1.52 : 1, F2.20–2.69, f=19.4–25.3 mm
NP13ZL	Throw ratio 1.46–2.95 : 1, F1.70–2.37, f=24.4–48.6 mm
NP14ZL	Throw ratio 2.90–4.68 : 1, F2.20–2.64, f=48.5–77.6 mm
NP15ZL	Throw ratio 4.59–7.02 : 1, F2.20–2.70, f=76.6–116.5 mm
NP40ZL	Throw ratio 0.79–1.11 : 1, F2.0–2.5, f=13.3–18.6 mm
NP41ZL	Throw ratio 1.30–3.02 : 1, F1.7–2.0, f=21.8–49.8 mm
NP43ZL	Throw ratio 2.99–5.93 : 1, F2.2–2.6, f=49.7–99.8 mm
NP50ZL	Throw ratio 0.60–1.75 : 1, F1.9–2.1, f=10.2–12.8 mm
NP44ML	Throw ratio 0.32 : 1, F2.0, f=6.27 mm

Lens model name \ Function	Motorized lens shift	Zoom		Focus			LENS CALL-BRATION	Home position (LENS HOME)	LENS MEMORY
		Motorized	Manual	Motorized		Manual			
				CENTER	PERIPHERY				
NP11FL	Yes	No	No	No	No	Yes	Yes*1	Yes	Yes*1
NP12ZL	Yes	No	Yes	No	No	Yes	Yes*1	Yes	Yes*1
NP13ZL	Yes	No	Yes	No	No	Yes	Yes*1	Yes	Yes*1
NP14ZL	Yes	No	Yes	No	No	Yes	Yes*1	Yes	Yes*1
NP15ZL	Yes	No	Yes	No	No	Yes	Yes*1	Yes	Yes*1
NP40ZL	Yes	Yes	No	Yes	Yes	No	Yes*2	Yes	Yes*2
NP41ZL	Yes	Yes	No	Yes	Yes	No	Yes*2	Yes	Yes*2
NP43ZL	Yes	Yes	No	Yes	No	No	Yes*2	Yes	Yes*2
NP50ZL	No	Yes	No	Yes	No	No	Yes*1	Yes	No
NP44ML	No	No	No	Yes	Yes*3	No	Yes*1	Yes	No

*1 Lens shift only

*2 Except [PERIPHERY] focus

*3 Adjust on the [LENS ZOOM] control screen

NOTE:

- The above throw ratio is for projecting on 100" screen.
- Use NP11FL at the home position. If necessary, fine-adjust the position of the projected image using the lens shift function.
- Fix the NP50ZL to the projector using the supplied support kit. Loosen the bolts of the support kit, you can adjust the lens shift.
- Fix the NP44ML to the projector using the separately sold support kit (NP01LK).

3-2. Troubleshooting





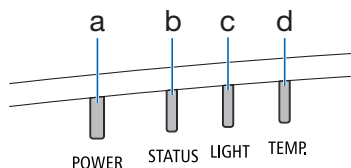























This section helps you resolve problems you may encounter while setting up or using the projector.











Feature of each indicator



a: POWER indicator
b: STATUS indicator
c: LIGHT indicator
d: TEMP. indicator

Indicator Message (Status message)

POWER	STATUS	LIGHT	TEMP.	Projector status
 Off	 Off	 Off	 Off	Power is off
 Orange (Blink ^{*1})	 Off	 Off	 Off	In the state of Standby ([STANDBY MODE] is [NORMAL])
 Orange (Light)	 Off	 Off	 Off	In the state of Standby ([STANDBY MODE] is [NETWORK STANDBY])
 Green (Light)	 Off	 Off	 Off	In the state of Sleep
 Blue (Light)	 Off	 Green (Light)	 Off	Powered state ([LIGHT MODE] is [NORMAL])
 Blue (Light)	 Off	 Green (Blink ^{*2})	 Off	Powered state ([LIGHT MODE] is [SILENT] or [LONG LIFE])
Status varies	 Orange (Blink ^{*3})	Status varies	 Off	[LENS CALIBRATION] implement request.
 Blue (Light)	 Green (Blink ^{*3})	Status varies	 Off	Performing the lens calibration

POWER	STATUS	LIGHT	TEMP.	Projector status
 Blue (Light)	Status varies	 Off	 Off	Shutter function is activating
 Blue (Blink* ²)	 Off	Status varies	 Off	[OFF TIMER] is activated (Powered state)
 Blue (Blink* ⁴)	 Off	 Off	 Off	Preparing for powering [ON]













*1 Repetition to light on for 1.5 seconds / off for 7.5 seconds

*2 Repetition to light on for 2.5 seconds / off for 0.5 seconds

*3 Repetition to light on for 0.5 seconds / off for 0.5 seconds / on for 0.5 seconds / off for 2.5 seconds

*4 Repetition to light on for 0.5 seconds / off for 0.5 seconds

Indicator Message (Error message)

POWER	STATUS	LIGHT	TEMP.	Projector status	Procedure
 Blue (Light)	 Orange (Light)	Status varies	 Off	A button has been pressed while the [CONTROL PANEL LOCK] is activated. ID numbers for the projector and the remote control do not match.	The [CONTROL PANEL LOCK] is activated. The setting must be canceled to operate the projector. Check the [CONTROL ID]
 Blue (Light)	 Off	 Orange (Light)	 Orange (Light)	Temperature problem	Ambient temperature is high. The projector's protection functions will activate depending on the temperature of the operating environment. Lower the room temperature.
 Red (Blink* ⁵)	 Off	 Off	 Off	Temperature problem	Ambient temperature is out of the operation temperature. Check if any obstruction stays near the exhaust vent.
 Red (Light)	Status varies	Status varies	 Off	Error requiring service support	Contact your dealer or service personnel. Make sure to check and inform indicator status for asking to repair.

*5 Repetition to light on for 0.5 seconds / off for 0.5 seconds

When the thermal protector is activated:

When inside temperature of the projector becomes too high or low, the POWER indicator start to red blink in a short cycle. After this happened, the thermal protector will activate and the projector may be turned off.

In this case, please take the below measures:

- Pull out the power plug from the wall inlet.
- Place the projector in cool place if it has been placed in high ambient temperature.
- Clean the exhaust vent if dust has accumulated on.
- Leave the projector for about one hour until inside temperature gets lower.

Common Problems & Solutions

Problem	Check These Items
Does not turn on or shut down	<ul style="list-style-type: none"> • Check that the power cord is plugged in and that the power button on the projector cabinet or the remote control is on. • Check to see if the projector has temperature error, If projector inside temperature is too hot or cool, it disabled to turn on the projector as the protection. Wait for a moment and try turn on the projector again. • Set [FAN MODE] to [HIGH ALTITUDE] when using the projector at altitudes approximately 5500 feet/1600 meters or higher. Using the projector at altitudes approximately 5500 feet/1600 meters or higher without setting to [HIGH ALTITUDE] can cause the projector to overheat and the projector could shut down. If this happens, wait a couple minutes and turn on the projector. If you turn on the projector immediately after the light module is turned off, the fans run without displaying an image for some time and then the projector will display the image. Wait for a moment. • In case it's hard to think the trouble is not caused on the above mentioned conditions, unplug the power cord from the outlet. Then wait 5 minutes before plugging it in again.
Will turn off	<ul style="list-style-type: none"> • Ensure that the [OFF TIMER] or [AUTO POWER OFF] is off.
No picture	<ul style="list-style-type: none"> • Check if the appropriate input is selected. If there is still no picture, press the INPUT button or one of the input buttons again. • Ensure your cables are connected properly. • Use menus to adjust the brightness and contrast. • Check that the SHUTTER CLOSE button is not pressed. • Reset the settings or adjustments to factory preset levels using the [RESET] in the Menu. • Enter your registered keyword if the Security function is enabled. • If the HDMI input signal cannot be displayed, try the following. Reinstall your driver for the graphics card built in your computer, or use the updated driver. For reinstalling or updating your driver, refer to the user guide accompanied with your computer or graphics card, or contact the support center for your computer manufacturer. Install the updated driver or OS on your own responsibility. We are not liable for any trouble and failure caused by this installation. • The signal may not be supported depending on the HDBaseT transmission device. In addition, RS232C interface may not be supported. • Be sure to connect the projector and notebook PC while the projector is in standby mode and before turning on the power to the notebook PC. In most cases the output signal from the notebook PC is not turned on unless connected to the projector before being powered up. * If the screen goes blank while using your remote control, it may be the result of the computer's screen-saver or power management software.
Picture suddenly becomes dark	<ul style="list-style-type: none"> • A hot room may trigger the projector's protection functions, which can result in a temporary reduction in luminance (brightness). Reduce the temperature in the room.
Color tone or hue is unusual	<ul style="list-style-type: none"> • Check if an appropriate color is selected in [WALL COLOR]. If so, select an appropriate option. • Adjust [HUE] in [PICTURE].
Image isn't square to the screen	<ul style="list-style-type: none"> • Reposition the projector to improve its angle to the screen. • Perform [KEYSTONE] when the trapezoid is distorted.

Problem	Check These Items
Picture is blurred	<ul style="list-style-type: none"> • Adjust the focus. • Reposition the projector to improve its angle to the screen. • Ensure that the distance between the projector and screen is within the adjustment range of the lens. • Has the lens been shifted by an amount exceeding the guaranteed range? • Condensation may form on the lens if the projector is cold, brought into a warm place and is then turned on. Should this happen, let the projector stand until there is no condensation on the lens.
Flicker appears on screen	<ul style="list-style-type: none"> • Set [FAN MODE] to other than [HIGH ALTITUDE] mode when using the projector at altitudes approximately 5500 feet/1600 meters or lower. Using the projector at altitudes less than approximately 5500 feet/1600 meters and setting to [HIGH ALTITUDE] can cause the light module to overcool, causing the image to flicker. Switch [FAN MODE] to [AUTO].
Image is scrolling vertically, horizontally or both	<ul style="list-style-type: none"> • Check the computer's resolution and frequency. Make sure that the resolution you are trying to display is supported by the projector.
Remote control does not work	<ul style="list-style-type: none"> • Aim the remote control's infrared transmitter towards the projector's remote control receiver. • Install new batteries. • Make sure there are no obstacles between you and the projector. • Stand within 20 m/787 inch of the projector. • If a [CONTROL ID] has been set, check whether the ID number for the remote control matches the ID number for the projector.
On-screen menu is not displayed	<ul style="list-style-type: none"> • Check whether On-screen mute is active. On-screen mute can be turned off using one of the following ways: <ul style="list-style-type: none"> - Press the OSD OPEN button while holding down the CTL button on the remote control. - Holding down the MENU button on the projector cabinet for at least 10 seconds.
Indicator is lit or blinking	<ul style="list-style-type: none"> • See the Indicator Message.

For more information contact your dealer.

3-3. Mounting a lens (sold separately)

Ten separate bayonet style lenses can be used with this projector. The descriptions here are for the NP13ZL (2x zoom) lens. Mount other lenses in the same manner.

Be sure to carry out [LENS CALIBRATION] after replacing the lens.

WARNING:

(1) Turn off the power and wait for the cooling fan to stop, (2) disconnect the power cord and wait for the unit to cool before mounting or removing the lens. Failure to do so can result in eye injury, electric shock, or burn injuries.

Important:

- The projector and lenses are made of precision parts. Do not subject them to shock or excessive forces.
- Remove the separately sold lens when moving the projector. If not, the lens could be subject to shock while the projector is being moved, damaging the lens and the lens shift mechanism.
- When dismantling the lens from the projector, return the lens position to the home position before turning off the power. Failure to do so may prevent the lens from being mounted or dismantled because of narrow space between the projector and the lens.
- Never touch the lens surface while the projector is operating.
- Be very careful not to let dirt, grease, etc., on the lens surface and not to scratch the lens surface.
- Perform these operations on a flat surface over a piece of cloth, etc., to prevent the lens from getting scratched.
- When leaving the lens off the projector for long periods of time, mount the dust cap on the projector to prevent dust or dirt from getting inside.
- Always use the included support kit to secure the projector body and lens unit after affixing the NP50ZL. Please refer to the NP50ZL Installation Manual for details.
- Always use the support kit (NP01LK, sold separately) to secure the projector body and lens unit after affixing the NP44ML. Please refer to the support kit's Instruction Manual for details.

Mounting the lens

1. Remove the dust cap from the projector.

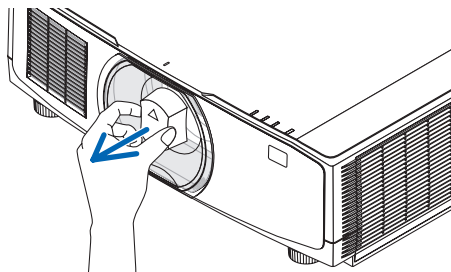

2. Remove the lens cap on the back of the lens.

NOTE:

- Make sure to remove the lens cap at the unit back side. If the lens unit with the lens cap remaining on is installed on the projector, it may cause of malfunction.

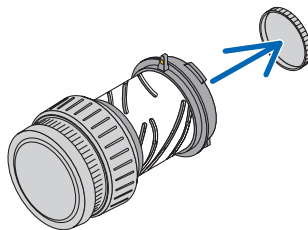

3. Align the protrusion on the lens with the guiding notch on the projector lens hole and insert the lens.

NP11FL/NP12ZL/NP13ZL/NP14ZL/NP15ZL:

- Each protrusion is marked in yellow.

NP40ZL/NP41ZL/NP43ZL/NP50ZL/NP44ML:

- The arrow mark in the label attached to the lens shows the position of protrusion.

Insert the lens slowly all the way in.

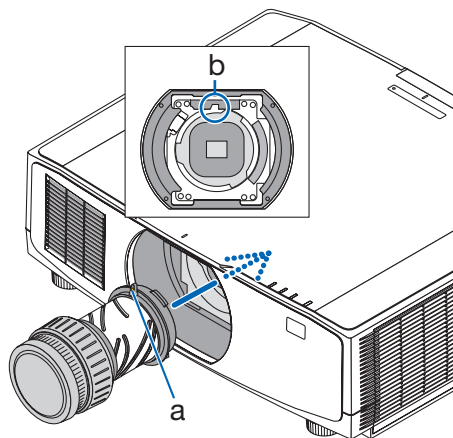

a: Protrusion / b: Guiding notch

4. Turn the lens clockwise.

NOTE:

- Do not press the lens release button at the bottom of the lens mounting section when attaching the lens unit. You will not be able to fix the lens unit in the correct position.

Turn until a click is heard.

The lens is now fastened onto the projector.

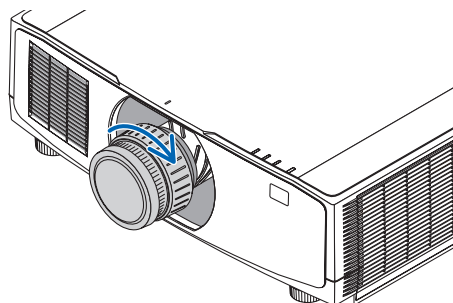

5. Mount the lens theft prevention screw.

Fasten the lens theft prevention screw included with the projector to the bottom of the projector so that the lens cannot be removed easily.

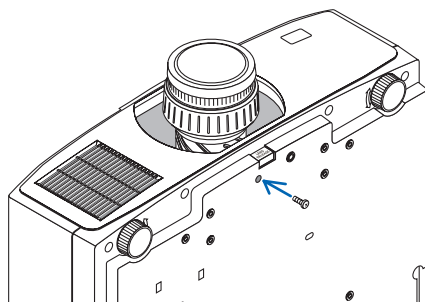

Removing the lens

Preparations:

1. Turn on the projector and display an image.
2. Press and hold the SHIFT/HOME POSITION button over 2 seconds.
The lens position will be moved to the home position.
3. Turn off the main power switch, and then unplug the power cord.
4. Wait until the projector cabinet is cool enough to handle.

1. Remove the lens theft prevention screw.

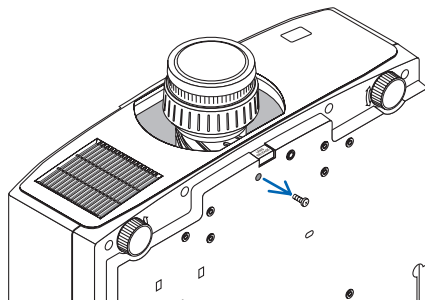

2. While pressing the lens release button at the bottom of lens mounting section on the projector's front panel fully in, turn the lens counterclockwise.

The lens comes off.

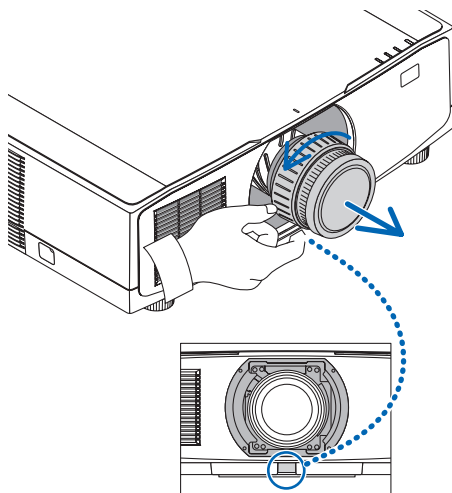

3. Slowly pull the lens off the projector.

- After removing the lens, mount the lens caps (front and back) included with the lens before storing the lens.
- If no lens is going to be mounted on the projector, mount the dust cap included with the projector.

Make sure the direction to mount the dust cap to face the distinguish mark (Δ) on the cap upward.

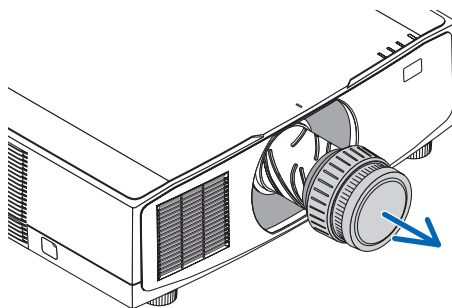

3-4. REGISTER YOUR PROJECTOR! (for residents in the United States, Canada, and Mexico)

Please take time to register your new projector. This will activate your limited parts and labor warranty and InstaCare service program.

Visit our web site at <https://www.sharpnecdisplays.us>, click on support center/register product and submit your completed form online.

Upon receipt, we will send a confirmation letter with all the details you will need to take advantage of fast, reliable warranty and service programs from the industry leader, Sharp NEC Display Solutions of America, Inc.

NEC